

WÄRTSILÄ

ENCYCLOPEDIA OF SHIP TECHNOLOGY

BY JAN BABICZ



**WÄRTSILÄ
ENCYCLOPEDIA
OF
SHIP TECHNOLOGY**

Second Edition

by Jan Babicz

First published 2008 by Biuro Okrętowe BAOBAB Jan Babicz

Second edition 2015 by WÄRTSILÄ CORPORATION

Copyright 2015 WÄRTSILÄ CORPORATION

DTP Layout: Cezary Spigarski, www.oficynamorska.pl

All rights reserved. No part of this publication may be reproduced in any form or by any means without prior written permission of the copyright holder.

Whilst every effort has been made to ensure that the information contained in this book is correct neither the Author nor WÄRTSILÄ CORPORATION can accept any responsibility for any errors or omissions or for any consequences resulting there from.

ISBN 978-952-93-5535-8 (hardcover)

ISBN 978-952-93-5536-5 (PDF)

www.shippingencyclopedia.com

Inside paper LumiForte 90 gsm / m² and cover paper LumiSilk 150 gsm / m², made by Stora Enso Oyj



storaenso



by Stora Enso

Acknowledgements

First of all, I would like to thank Mikael Simelius, who inspired me to prepare the second edition of this work. I am also indebted to Paul Glandt, who supervised the project and to the whole team of proofreaders who read the text and gave their valuable comments. I would also like to express my gratitude to companies and individuals who provided me with pictures, illustrations and information used in this book.

*Jan Babicz
Gdańsk September 2014*

**WÄRTSILÄ
ENCYCLOPEDIA
OF
SHIP TECHNOLOGY**

Second Edition

Compiled by

JAN BABICZ

Consulting Naval Architect & Ship Surveyor

HELSINKI 2015

Foreword

It is with great pleasure and pride that we present this second edition of the Wärtsilä Encyclopedia of Ship Technology. With 180 years of experience behind us, and as a technology leader in the marine industry's global transition to greater efficiency, lower operating costs and enhanced environmental performance, we are in a unique position to influence the future of this industry.

One of the ways in which we seek to strengthen the growth and secure the future of commercial shipping is to pass on the know-how that we have gained to future generations of maritime professionals. This encyclopedia is evidence of this commitment.

At Wärtsilä, we strongly believe that the marine industry must adapt to the new realities imposed by rising construction and operating costs, the need for operational and fuel flexibility, and increasingly stringent environmental regulations. These factors have led to the rapid development and adoption of new technologies, and in this Wärtsilä has taken a leading role. It is only through improving the overall efficiency of operating vessels that these challenges can be met.

Today Wärtsilä, as a total solutions provider to the marine and oil & gas industries, has a portfolio of marine products and systems that cannot be matched by any other company. Our position as an innovative technology leader has also been enhanced through some key acquisitions of leading companies with proven track records and unique offerings. The combination of our years of experience and extensive in-house know-how, together with the expertise acquired through acquisitions, has enabled Wärtsilä to better serve its global customers and provide real and meaningful support throughout the entire lifecycle of their vessels. From initial design, to engineering, to providing a single source of supply that saves time and costs, to support from the industry's most comprehensive service network, Wärtsilä offers a shorter route to customer profits. A full review of what Wärtsilä offers can be found at www.wartsila.com. We hope that you will make use of this encyclopedia and in so doing, help to accelerate the move toward a more economically and environmentally sustainable future for the marine sector.

April 2015

Jaakko Eskola

Senior Executive Vice President and President, Ship Power

Wärtsilä Corporation





This is Wärtsilä

Wärtsilä is a global leader in technologies and lifecycle solutions for the marine and energy markets. In 2014, Wärtsilä's net sales totalled EUR 4,8 billion with approximately 17,700 employees. The company has operations in more than 200 locations in some 70 countries around the world. Wärtsilä is publicly listed on the Nasdaq Helsinki exchange in Finland. The company has three businesses; Ship Power, Power Plants and Services.

The extent of Wärtsilä's global reach in the marine sector is exemplified by the fact that one in every three ocean going vessels has a Wärtsilä solution. The company has an unmatched portfolio of products, solutions and ship design services that enables it to be a total solutions provider to its customers. Wärtsilä's technology leadership position has time and again led to key developments that are meeting the challenges faced today by ship owners and operators around the world. These can be seen, for example, in the fuel flexibility of Wärtsilä engines that has led to Liquefied Natural Gas (LNG) being increasingly adopted as a clean and competitively priced marine fuel. In addition to its ship machinery, the company also offers generating sets, reduction gears, propulsion equipment, control systems, sealing solutions, and a broad range of environmental solutions that includes exhaust scrubber systems, ballast water management systems and other solutions that enable compliance with global and local regulations. Wärtsilä's recent acquisition of L-3 MSI will bring a broad range of competences within the area of Electrical & Automation (E&A), which will form an unmatched and comprehensive E&A offering. Wärtsilä commands a strong position in all marine segments as well as in the offshore oil & gas industry.

Wärtsilä Power Plants is a leading global supplier of flexible baseload power plants of up to 600 MW operating on various gaseous and liquid fuels. The company's portfolio includes unique solutions for peaking, reserve and load-following power generation, as well as for balancing intermittent power production. Wärtsilä Power Plants also provides LNG terminals and distribution systems. In addition to the technical advantages, Wärtsilä's fast track deliveries of complete power plants, together with long-term operation and maintenance agreements, provide customers with complete solutions— in urban areas as well as in the most demanding remote environments. As of 2015, Wärtsilä has installed more than 4,700 power plants in 175 countries, with a total combined capacity of 55 GW.

Wärtsilä Services provides support to its Ship Power and Power Plant customers throughout the lifecycle of their installations by optimising efficiency and performance. The company provides the most comprehensive portfolio of services and the broadest service network in the industry. High quality, expert support, and the availability of services in the most environmentally sound way possible -, regardless of the location of the customer. Wärtsilä has also launched innovative new services, such as service for multiple engine brands in key ports, predictive and condition based maintenance, tailored online services, and full operations and management contracts for customer installations. Wärtsilä is committed to carrying out its business in a sustainable way. Wärtsilä's Code of Conduct and sustainability programmes are aligned with the UN Global Compact. In order to promote the long-term interests of Wärtsilä and its stakeholders, the company strives to maintain the highest legal and ethical standards in all its operations.

Abandonment – All operations required for breaking out stowage and the safe disengagement and clearing away of the **life-saving** equipment with full complement from the stricken ship.

Able-bodied seaman (A.B.) – A member of the deck **crew** who is able to perform all the duties of an experienced seaman; must have three years of sea service.

Abnormal condition – A condition that occurs in a process system when an operating variable (flow, pressure, temperature, etc.) ranges outside of its normal operating limits, (ABS).

Abrasion – Scraping or wearing away, rubbing off.

Abrasion resistance – Resistance to frictional rubbing.

Abrasive – Agent used for blast cleaning before coating application.

Abrasive blasting – Cleaning of steel with **abrasives** propelled by compressed air jet preparatory to painting.

Grit blasting, shot blasting – A cleaning process for metal plate in which dry metal shot or steel grit is projected at the surface. Open grit blasting is still the most popular way to prepare surfaces for coating. This method gives an ideal foundation for paint, and blast-cleaning combined with a modern, correctly used paint system will make the paint last 4-5 times longer than corresponding surfaces pretreated in a conventional way. Unfortunately, the dust caused by grit blasting poses health risks and can restrict the work of other trades. The use of hydrojetting (high pressure water blasting) or slurry blasting (grit media and water) can reduce this problem.

Sand blasting – An abrasive cleaning method for steel plating which may use dry sand or a sand and water mixture.

Absorbent material – Substance that is able to take in moisture, oil, etc.

Acceleration – The rate of velocity change or the average increase of velocity in a unit time, usually expressed in meters per square seconds (m/s^2).

Accelerometer – A mechanical or electromechanical instrument that measures acceleration.

Acceptance tests, acceptance trials – A series of tests performed on a material, a machine or a system, in the presence of the purchaser or a surveyor to demonstrate suitable quality or operation. See also **Dock tests**, **Sea trials**.

Accessibility – The ability for personnel to access equipment easily that requires maintenance, inspection, removal or replacement while wearing the appropriate clothing, including personal protective equipment and using all necessary tools and test equipment.

Accident – An event that happens unexpectedly and causes damage, injury, etc.

Accident categories (acc. to Lloyds Maritime Information Services casualty database) – The LMIS casualty database divides the accidents into the following categories:

1. **Foundered** – includes ships which sank as a result of heavy weather, leaks, breaking into two, etc, and not as a consequence of other categories such as collision etc.
2. **Missing vessel** – includes ships that disappeared without any trace or witnesses knowing exactly what happened in the accident.
3. **Fire/explosion** – includes ships where fire/explosion is the first event reported, or where fire/explosion results from hull/machinery damage, i.e. this category includes fires due to engine damage, but not fires due to collision etc.

4. **Collision** – includes ships striking or being struck by another ship, regardless of whether under way, anchored or moored. This category does not include ships striking underwater wrecks.
5. **Contact** – includes ships striking or being struck by an external object, but not another ship or the sea bottom. This category includes striking drilling rigs/platforms, regardless of whether in fixed position or in tow.
6. **Wrecked/stranded** – includes ships striking the sea bottom, shore or underwater wrecks.
7. **War loss/hostilities** – includes ships damaged from all hostile acts.
8. **Hull/machinery damage** – includes ships where the hull/machinery damage is not due to other categories such as collision etc.
9. **Miscellaneous** – includes lost or damaged ships which cannot be classified into any of the categories 1 through 8 due to not falling into any of the categories above or due to lack of information (e.g. an accident starting by the cargo shifting would typically be classified as miscellaneous).

Accommodation – The part of the ship which is used for cabins, dining areas and other crew facilities. **SOLAS** defines accommodation spaces as spaces used for **public spaces**, corridors, lavatories, cabins, offices, hospitals, cinemas, games and hobby rooms, barber shops, pantries containing no cooking appliances and similar spaces.

“With reduction in staffing and increases in the complexity of on-board systems, it is vital that crew members are provided with supportive accommodation spaces. Proper accommodations design and appropriate ambient environment enhance the safety, productivity, morale and overall well-being of crew.” “Conversely, improper accommodations design can adversely impact the crew members’ ability to reliably perform their duties, fully relax, sleep and recover from mentally and physically demanding work activities. This in turn may impact their ability to carry out duties on succeeding watches with the required diligence and accuracy.”

Source: ABS Guide for “**Crew Habitability on Ships**” (2001),
can be downloaded from www.eagle.org

Accommodation ladder – A portable ladder hinged to a platform attached to the side of a ship and which can be positioned to provide access between ship and shore. Telescopic accommodation ladder is used for covering a long distance between the vessel and port quay. According to amendments to SOLAS Convention ships constructed on or after 1 January 2010 shall be provided with means of embarkation on and disembarkation from ships for use in port, such as gangway and accommodation ladders. See also **Boarding arrangement**.

Accumulation test of the boiler – A boiler test to ensure that the safety valves can release steam fast enough to prevent the pressure rising by 10%. The main steam stop valve is closed during the test.

Acetylene – A colourless, poisonous gas used with oxygen for oxy-acetylene metal welding or cutting.

Acquisition – The selection of the target vessels requiring a tracking procedure and the initiation of their tracking.

Act of God – An unpredictable situation which is beyond the power of man. A natural event, not preventable by any human power, such as flood, storms, or lightning usually quoted as “force majeure”.



Accommodation ladder

To enable an efficient control of persons arriving onboard in port, it is very good to have the accommodation ladder, which leads directly to a reception point near the Deck Office.

Active-fin stabilisers – The reduction of rolling provides better fuel/speed performance on rough seas, enhances crew safety and possibly their efficiency. The roll amplitude can be reduced by passive devices, such as **bilge keels**, or by active devices, such as hydrofoil-shaped fins usually located near amidships, port side and starboard. In a seaway, hydraulic tilting gear continuously varies the angle of attack of the fins, to produce heeling moments reducing the ship tendency to roll. Active-fin stabilisers require ship forward motion in order to develop lift. They are available as folding types or non-retractable construction. For many years active-fin stabilisers have been applied on cruise ships and passenger vessels as a means of reducing excessive rolling. Today, owners of other types of vessels, especially large containerships, are increasingly specifying fin stabilisers.

For more information visit www.simplex-turbulo.com

ACTIVE-FIN STABILISERS

Illustrations courtesy of Rolls-Royce

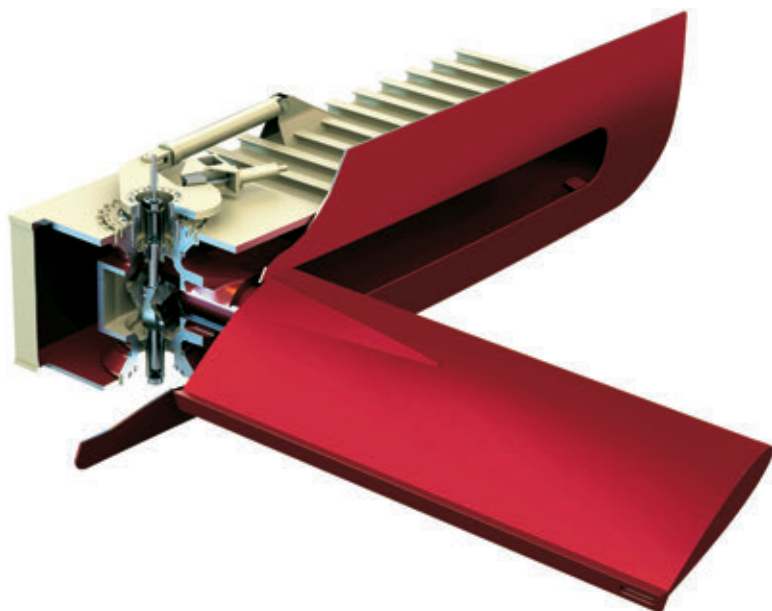

The Brown Brothers Neptun II folding stabilisers for large vessels. Fin area: 4.2 - 22.33 m², total weight: 36.5 - 190 tonnes. The transatlantic liner QUEEN MARY 2 features four sets of 15.63 m² Neptune folding stabilisers.

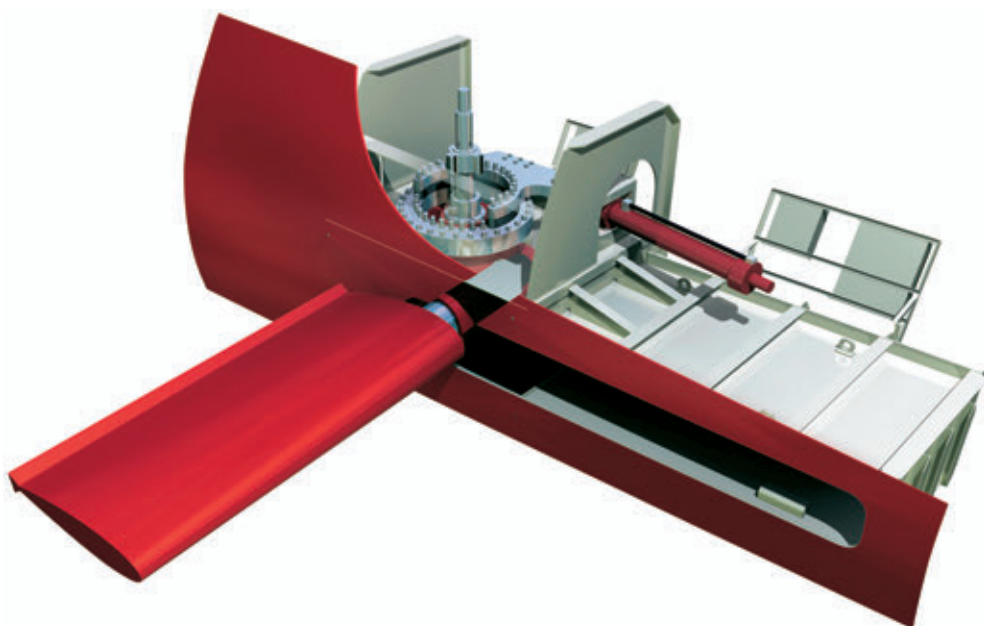

The Brown Brothers Aquarius folding stabilisers designed for small cruise ships, passenger ferries, small naval and coastguard vessels. Fin area: 1.82 - 5.78 m², total weight: 19.3 - 40.2 tonnes.

ACTIVE-FIN STABILISERS

Illustrations courtesy of Rolls-Royce

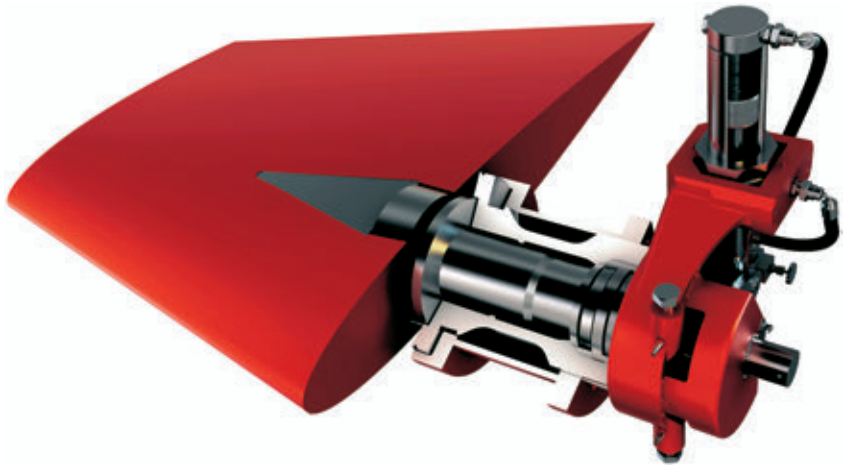

***The Brown Brothers Gemini non-retractable stabilisers designed for smaller vessels.
Fin area: 1.4 - 3.2 m², total weight: 1.92 - 6.75 tonnes.***

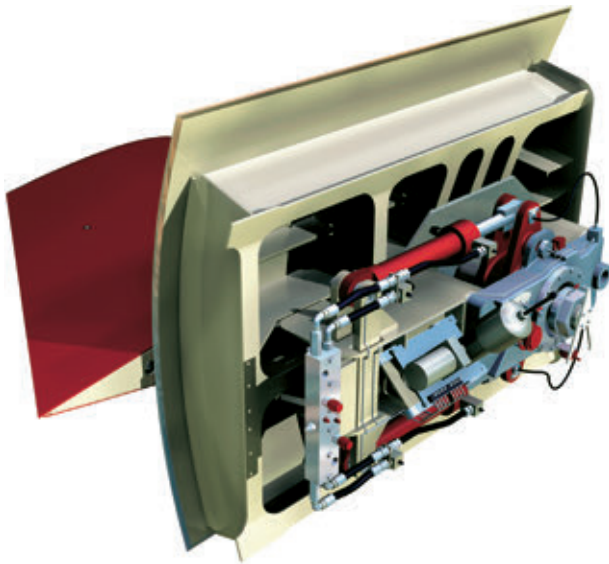

***The hull-closing plate is included
as an integral part of the fin unit.***

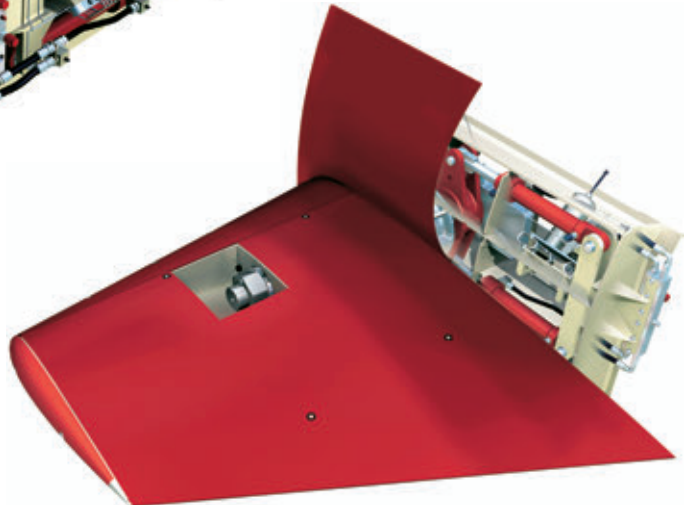

The Brown Brothers Modular non-retractable stabilisers meet military standards for noise, shock and vibration levels.

Active heave-compensation (AHC) technology – Offshore cranes and other equipment doing subsea work are provided with AHC systems to ensure precision in high sea states and extreme weather conditions. The essential function of AHC technology is the ability to land and retrieve subsea installations to and from the seabed with precision and accuracy, while minimising the impact caused by the motion of the vessel. The major principle of AHC technology is based on advanced motion sensors that measure the vessel's heave, pitch and roll and calculate resulting geometrical estimate of heave motion of the point where a lifting wire exits the vessel. AHC uses complex electro-hydraulic PLC controlled systems to control the movement of the lift wire so that the motion introduced by the crane-tip is damped as much as possible. It enables modern subsea vessels to continue working with loads near the seabed under increasingly adverse weather conditions.

Actuator – A motor providing rotary or linear motion.

Adblue – Registered trademark for AUS32 (Aqueous Urea Solution 32.5%) and is used in a process called selective catalytic reduction (SCR) to reduce emissions of oxides of nitrogen from the exhaust of diesel engine motor vehicles.

Added mass – The mass of water which is considered to be set in motion by a ship when heaving, pitching, rolling and vibrating.

Additives – Chemicals added to fuel, lubricating oils or fresh water to improve their physical or chemical characteristics.

Adhesion of a coating – Bonding strength; the attraction of a coating to the substrate, or to another film of paint or any other material such as steel.

Adhesive – Substance that makes things stick.

Adiabatic – A thermodynamic process described by that no heat is added or removed from the system.

Admeasurements – The confirmed or official ship dimensions.

Administration – As used in international conventions, the government of the state whose flag the ship is flying.

Maritime administrations – Governmental organizations, such as the United States Coast Guard (USCG), UK Marine Safety Agency (UK MSA), Norwegian Maritime Directorate (NMD), etc., that provide maritime services such as the issuance of certificates and classification of ships for safety. The flag state administrations are responsible for overseeing the worldwide construction and operation of ships in accordance with international and national laws. However many countries delegate this responsibility to **classification societies** in order to take advantage of their expertise and worldwide network of surveyors.

Port administration – The appropriate authority of the country in the port of which the ship is loading or unloading.

Admiralty coefficient, Admiralty constant – A coefficient used in the preliminary estimations of the power required in a new design to attain the desired speed. It is presented by the formula:

$$C = \frac{D^{2/3} \cdot V^3}{P}$$

where: D = displacement in tons, V = speed in knots, P = shaft power in kW.

Values range from 400 to 600, the higher the value the more economic the vessel.

Adrift – Floating, not controlled, without a clearly determinable direction. A vessel is said to be adrift when she breaks away from her moorings.

Adsorbent – A solid substance used to remove components from a gas being processed.

Adsorption – Adhesion of molecules from a gas or liquid to a surface. Typical examples are instrument or inert gas driers. Should not be confused with absorption.

Advance – The distance that the ship has advanced in a direction parallel to the original course measured from the point where the helm was put over. See also **Manoeuvring parameters**.

Afloat – In a floating condition; the opposite of **aground**.

Aframax tanker – A tanker with deadweight of 79,999dwt, however the term Aframax is generally used for tankers in the 50,000 – 100,000dwt capacity range. See also **Tanker**.

Illustrations courtesy of Stena Bulk



Ice - Aframax STENA ARCTICA

Aft peak – A compartment located aft of the aftermost watertight **bulkhead**.

Aft peak bulkhead – A term applied to the first main transverse watertight bulkhead forward of the stern.

Aft peak tank – The compartment in the narrow part of the stern aft of the aft peak bulkhead.

Aft perpendicular (AP) – The aft perpendicular passes through the aft end of the freeboard **length L**.

A-frame –

1. A type of lifting gear often installed on stern of **cable vessels**, **pipe-lying vessels** and **offshore construction vessels** for sub sea load handling.
2. A fabricated steel structural element of a slow speed, two-stroke diesel engine. It stands on the bedplate above the main bearings.

Afterbody – That portion of a ship hull aft **amidships**.

After shoulder – The part of the ship form where the **parallel middle body** and the **run** meet.

Aground – When a vessel rests on something solid other than the blocks in a dry-dock or slipway she is said to be aground.



200t A-frame

AHTS SIEM PEARL

Anchor Handling, Tug, Supply Vessel SIEM PEARL, based on Wärtsilä Ship Design's VS491 CD design, was delivered in 2009 by Kleven Yard in Ulsteinvik (Norway).

Anchor handling equipment consists of a Rolls-Royce Brattvaag 500t covered towing and anchor handling winch of waterfall type with socket compartments and spooling devices. There are four 170m³ chain lockers with a total capacity of 9400m of 76mm chain.

Cargo carrying capacities include approximately 3000m³ drill water, 650m³ liquid mud, 650m³ brine and 300m³ dry bulk. The aft cargo deck measures 44.5m by 18m providing an 810m² area capable of accommodating about 1600t of cargo with a deck strength of 10 t/m². A unique feature is the Triplex MDH gantry crane for safe and man-free anchor handling operations while two U-shaped roll reduction tanks provide a more stable working environment.

The hybrid power plant combines diesel-electric and diesel-mechanical transmission. In combination with selective catalytic reduction and efficient hull design, this resulted in low fuel consumption and minimum exhaust emissions.

The main propulsion is via a twin screw CPP driven by a combination of diesel engines and variable speed electric motors. For each shaftline, one Wärtsilä main diesel engine 16V32 and one electric motor are connected to a Wärtsilä gear. The main engine has a power take off in the front end, driving a shaft generator (3000kW at 720 rpm). With this arrangement the main engine can be used as the propulsion engine at variable speed, the propulsion engine at constant generator speed, or as a generator motor disconnected from the propeller.

The variable speed electric motors have two nominal ratings and speeds. When operating in parallel with the diesel engine the nominal speed is 1370rpm, which is required in order to match the nominal propeller speed of 144rpm. When operating as the only propulsion

ANCHOR HANDLING/TUG/SUPPLY VESSEL VS 491

Illustration courtesy of Wärtsilä Corporation

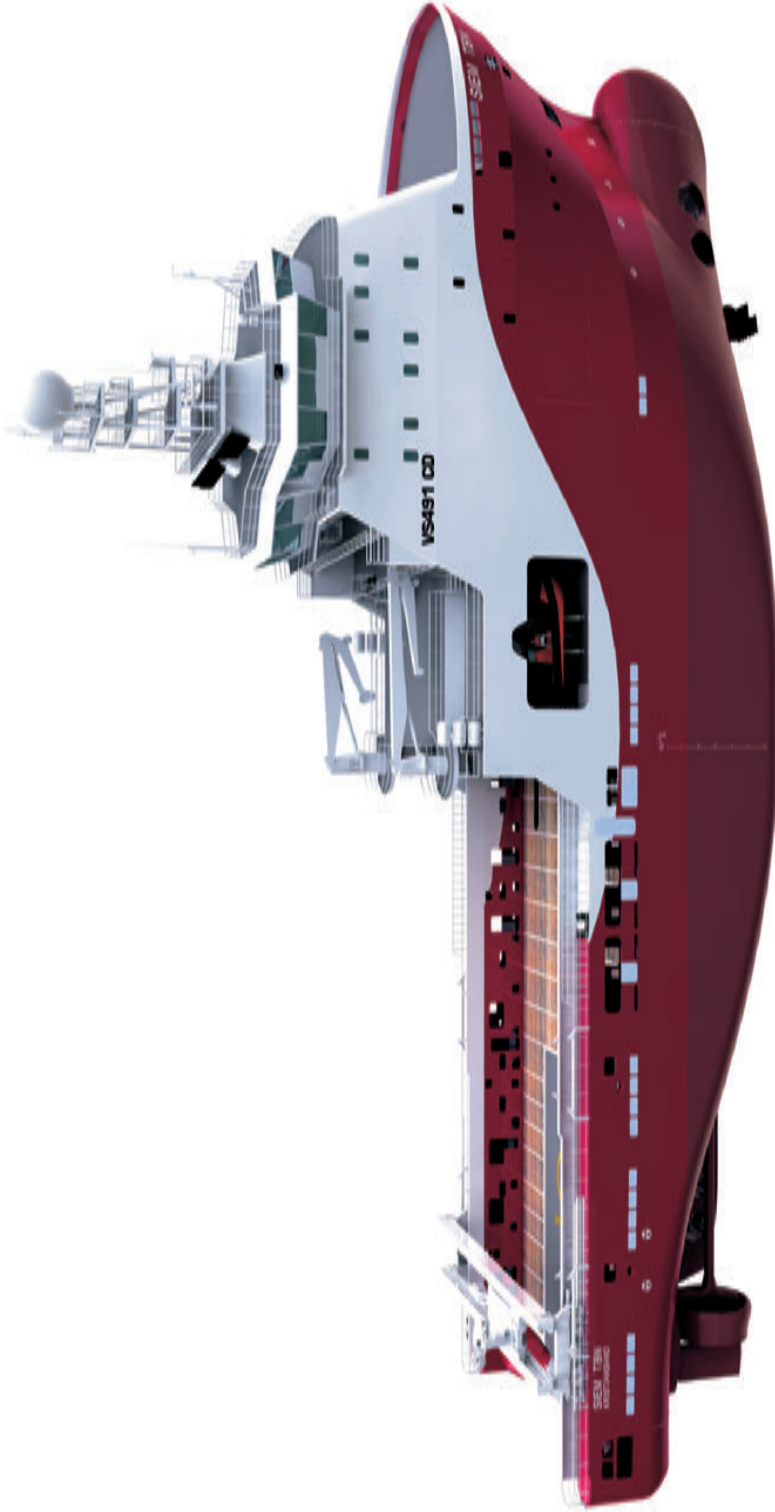

Aids to navigation

motor, the nominal speed is 800rpm, equal to a propeller speed of 84rpm. There are also two 2100kW 3516C generator sets and a 425kW emergency/harbour generator.

The Wärtsilä power drive system, based on low voltage 690V/60Hz, eliminates the propulsion transformers used by a traditional 6.6kV/60Hz power drive system. Elimination of the high voltage propulsion transformers gives the following benefits:

- Electrical losses in transformers eliminated (15-20% of total electrical losses),
- Weight and volume of bulky transformers is eliminated,
- Low voltage system makes a more flexible switchboard,
- Centralized location of the vital equipment (in one room) enable easy operation control and maintenance.

Each of the two main 4200mm diameter Wärtsilä Lips **CP propellers** with **HR nozzles** provides an MCR output of 9500kW. These are supplemented by two 1000kW tunnel thrusters forward, one 830kW retractable azimuthing thruster forward and two 880kW tunnel thrusters aft. This propulsion system gives the vessel a DP2 capability. In addition, two Rolls-Royce high-lift rudders are fitted to enhance manoeuvrability.

Length, oa: 91.00m, Length, bp: 79.35m, Beam, mld: 22.00m, Depth, mld to the main deck: 9.60m, Draught: 7.95m, Max deadweight: 4161dwt, Lightship mass: 6069t, Deck space: 813m², Deck cargo capacity: 1600t, Output: 2x8000kW + 2x1600kW, Azimuth thruster 830kW, Tunnel thrusters: 2x1000kW, 2x880kW. Speed: 10knt at 12t, 12knt at 18t, 14knt at 32t, 16knt at 60t, 18knt at 72t, Bollard pull: 285-310t.

Aids to navigation – Charted marks such as buoys, beacons, lights, radio beacons and the like.

Aids to navigation service and buoy laying vessel RELUME

According to **HSB International** September 2004

The sophisticated light tender RELUME was built by the Dutch shipbuilding group Damen for Middle East Navigation Aids Service (MENAS), which plays a major role in maintaining the safety of shipping in the Arabian Gulf. The vessel was launched at Galatz Shipyard, Romania. To avoid steel cutting and re-working at Royal Schelde, much of the heavy machinery and electrical components had been fitted on board during construction work in Romania. The vessel is ideally equipped to repair and reposition navigation aids and to search for, locate and mark marine hazards. To provide coverage of all Gulf waters, the vessel have been complemented by workboats specializing in the service of shallow water aids to navigation.

Deck equipment includes a TTS crane of the electro-hydraulic type, with an SWL of 25t at 20m, the crane is specifically designed to handle a wide variety of navigation buoys and features a two hook/winch operation. Each hook/winch can be operated independently or synchronised in buoy-handling operations, and a constant tensioning system is installed to ease the hook-on operation. The crane is dimensioned to handle a wide variety of buoy sizes. Deck equipment further includes 2x15t buoy handling capstans, and 2x5t tugger winches. The spacious workdeck had been such designed that the vessel can carry twenty large navigation buoys.

Further to its primary role to lay, retrieve and maintain aids to navigation, the vessel has additional functions. The specifications include oil pollution recovery, hydrographic survey work, towing, the carriage of containers for rig supply and dive support facilities for rig inspections.

Photo courtesy of Remontowa Shipyard



The Northern Lighthouse Board's new multi-function light tender NLV PHAROS

Built by the Remontowa Shipyard in Gdansk, the vessel helps to maintain and repair navigation buoys, unlit beacons, automatic lighthouses, racons and DGPS stations which the Northern Lighthouse Board is responsible for around the coasts of Scotland and the Isle of Man. In addition to her main tasks, the vessel is also capable of locating wrecks and conducting hydrographic surveys. Diesel-electric power generation is via three 1370kW and two 685kW Wärtsilä L20 diesel generating sets.

The engine room accommodates two 1317kW 8-cylinder diesel generator sets and two 988kW 6-cylinder generators made by Wartsila for both the **diesel-electric propulsion** of the two azimuth thrusters, with a 2300mm diameter fixed pitch propeller fitted in a nozzle. Both thrusters are driven by frequency controlled E-motor drives of 1500kW at 1800rpm.

Fitted forward are two tunnel thrusters fitted with high skew CP propellers driven by 650kW E-motors. Rolls-Royce Marine supplied a controlled passive Interking stability tank. The stabiliser system, operating at low and zero speed of the vessel, consists of a U-shape tank fitted with 10 maintenance-free valves. Tank capacity at service level is 190m³ and the stabiliser wave slope capacity is up to 5 degrees. The maximum stabilising moment is 425t.

Length, oa: 82.60m, Length, bp: m, Breadth, max: 16.50m, Depth to main deck: 6.80m, Draught design/maximum: 4.00/4.50m, Deadweight maximum: 1500dwt, Gross tonnage: 3529, Propulsion power: 2x1317kW + 2x988kW, Trial speed: 13.50 knots.

Aids to navigation service vessel – The vessel specially equipped to maintain and repair navigation **buoys, beacons**, automatic lighthouses, etc.

AIDS TO NAVIGATION SERVICE AND BUOY LAYING VESSEL NLV PHAROS

Illustrations courtesy of Remontowa Shipyard

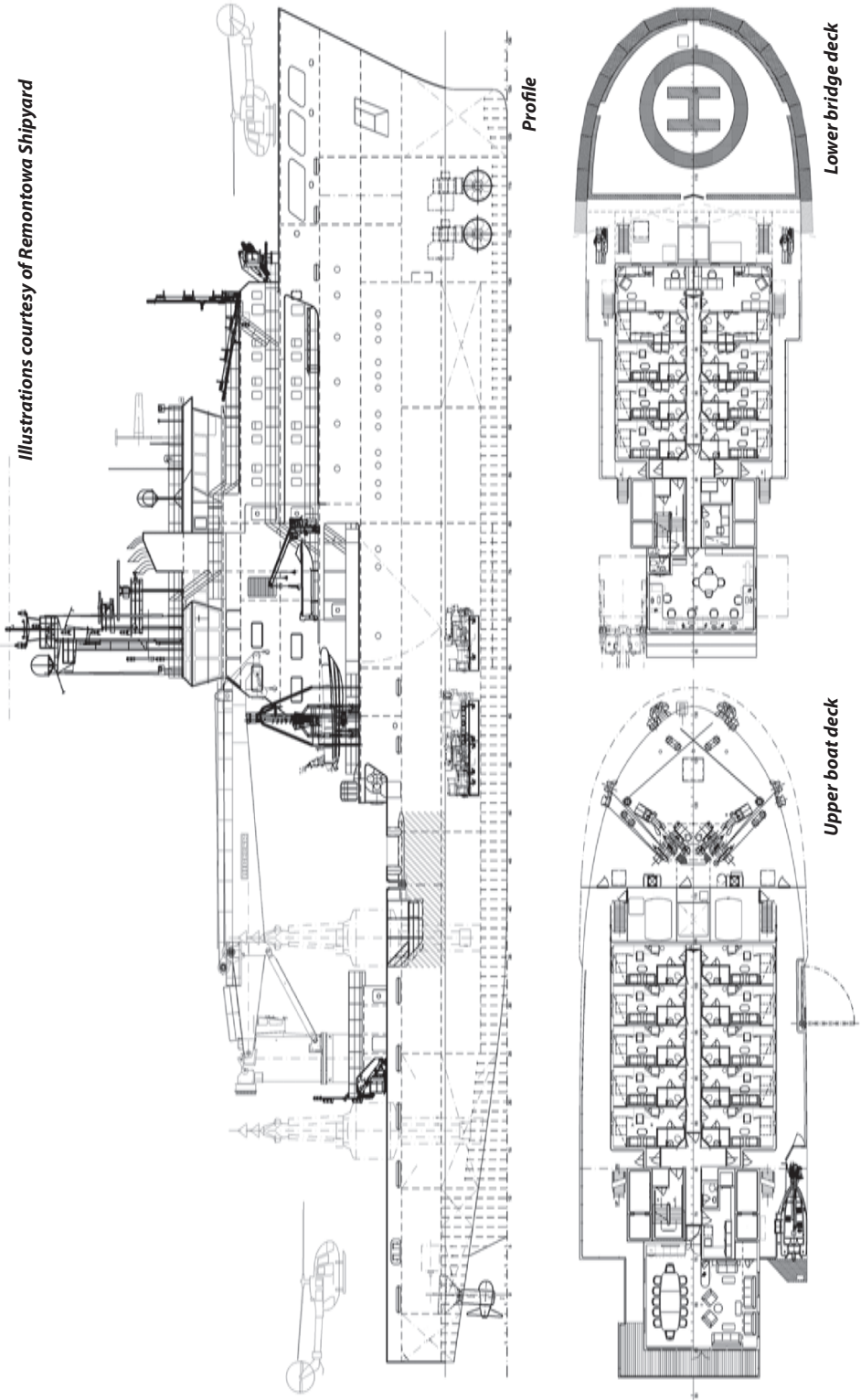

NLV PHAROS

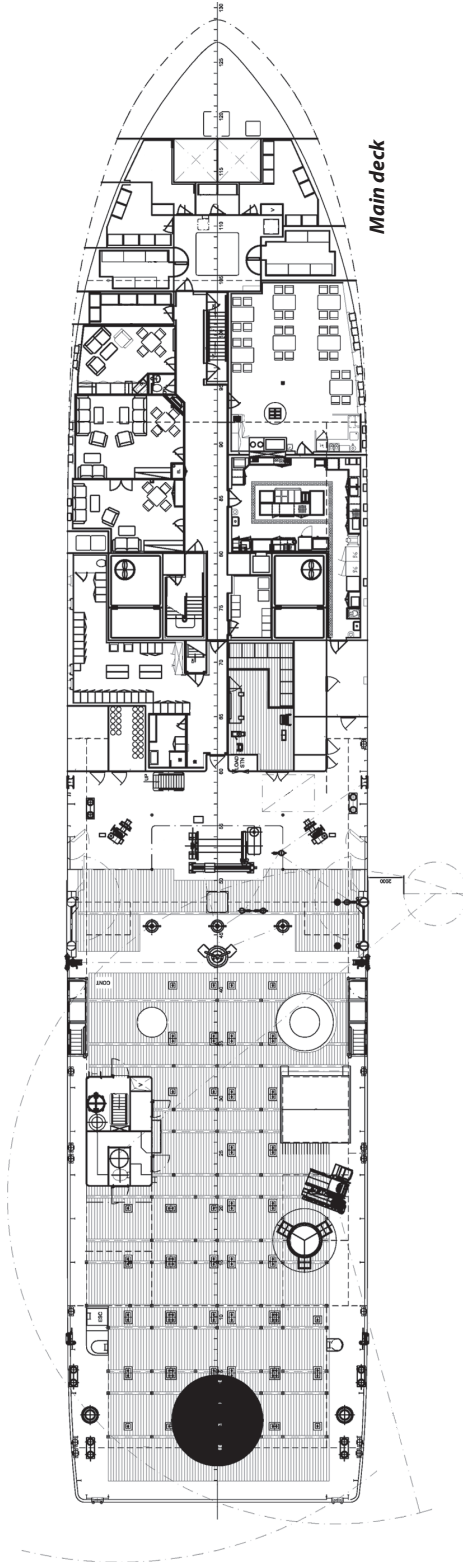

$L_{OA} = 84.20m$, $B = 16.50m$, $D = 7.20m$, $d = 4.28m$

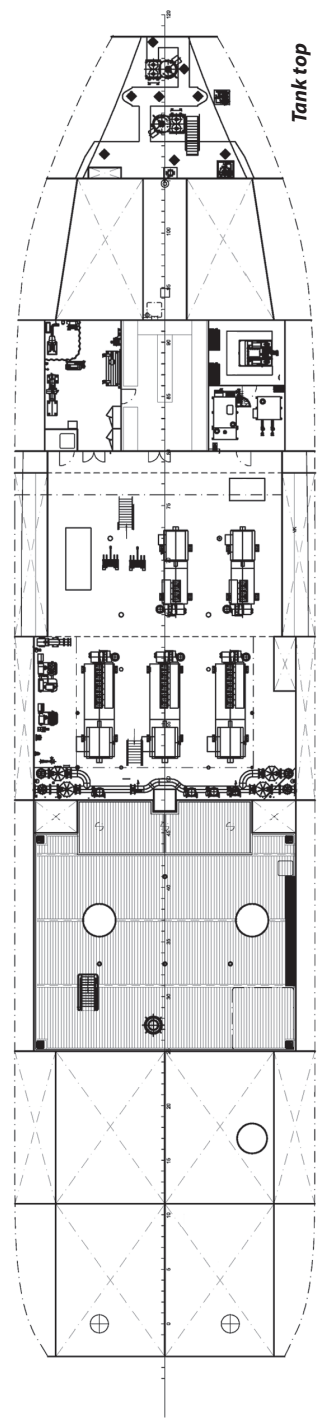

Air compressor

Air compressor – Usually two-stage, two-crank machine used aboard ship to supply compressed air. The air is compressed in the first stage, cooled and compressed to higher pressure in the next stage. Compressors must always be started at the unloaded condition since otherwise pressures build up rapidly producing very high starting torques.



Photo: C. Spigarski

*Air compressors onboard the 4444 TEU container vessel
MSC FLORIDA built by Gdynia Shipyard*

Air conditioning – The control of temperature and humidity in a space together with the circulation, filtering and refreshing of the air.

Air conditioning system – A typical recirculating system contains a fan to produce the airflow through the system, a cooling coil where the heat from the air is transferred to the cooling medium, and ductwork to distribute the air through duct terminals and to return the air to the cooling coil. Many recirculating systems contain heaters for use in the heating season or for use in maintaining a specific relative humidity requirement.

For more information visit www.heinenhopman.com

Air cooler, charge air cooler – A **heat exchanger** used to cool and, therefore, increase the specific density of air prior to combustion in an engine.

Air cooler cleaning system – The airside of the scavenge air cooler is cleaned by a chemical fluid injected into a spray pipe arrangement. Polluted cleaning agent returns through a filter, to the chemical cleaning tank. The cleaning must be carried out while the engine is at the standstill.

Air cushion vehicle (ACV), hovercraft – A craft with the whole or a significant part of its weight supported, whether at rest or in motion, by a continuously generated cushion of air with its effectiveness dependent on the proximity of the surface over which the craft operates.

Air draft – The vertical distance from the waterline to the highest fixed part of a vessel.

WÄRTSILÄ HAMWORTHY COMPRESSORS

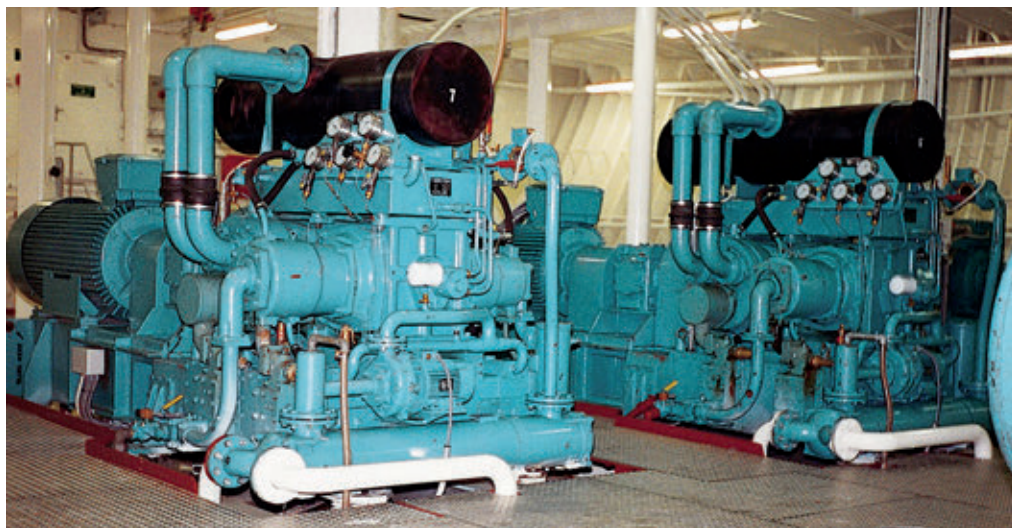

Wärtsilä Hamworthy seismic compressors

Wärtsilä Hamworthy seismic compressors feature a low lift concentric valve and generous inter-stage cooling to minimise the amount of absorbed power. This results in very high overall efficiency. Each machinery package includes a choice of drive, skid base and control system.



Wärtsilä Hamworthy rig tensioning compressor

The combination of a 4 stage compressor, dryer, and filtration package with a contained cooling system, produces filtered and dry, high pressure air or gas suitable for riser tensioning and other offshore applications.



Air cushion vehicle

Air dryer – A unit used to remove moisture from control air. It may use a **refrigerant drier** or a **desiccant**.

Air-drying paints – Paints which dry and form a film while exposed to air. Oil and alkyd paints are usually air-drying.

Air duct – Thin-walled piping or ducting (circular or rectangular) used exclusively to conduct air.

Air-fuel ratio (AFR) – Air-fuel ratio is the mass ratio of air to fuel present during combustion.

Air gun – Air guns are devices that rapidly release compressed air into water creating the effect of explosion. To provide sufficient energy for geophysical surveys, compressors generating extremely high pressures are required.

Air heater – A **heat exchanger**, which uses steam, water or electricity to increase the air temperature.

Air lock – An enclosed space for entrance between an outdoor **gas dangerous zone** on open deck and a **gas safe space**, arranged to prevent ingress of gas to the gas safe space.

Air lubrication – An innovative concept of reducing hull friction by means of air lubrication. A layer of air is generated between the specially profiled underside and water surface, so that the vessel effectively glides through the water, reducing drag by 5-15%.

Vessels which are wide-bodied, slow-moving and have a small draft, such as heavy lift and module carriers, should benefit the most from air lubrication systems.

Mitsubishi Air Lubrication System (MALS) is a proprietary technology by MHI that reduces hull friction by blowing out a constant layer of small air bubbles along the bottom of a ship's hull. Air discharged from blowers is temporarily stored in a head tank and air supply branch pipes connected to the head tank are piped to the air supply portion mounted on the bottom of the hull. One air supply branch pipe is each connected to one air chamber. All of these chambers are recessed.

The MALS was installed in each of twin-designed NYK-Hinode Line ocean-going vessels, the 19,800 dwt YAMATAI and YAMATO; the first in March 2010, and the other in the following November. These two ships are special heavy load carriers with roll-on, roll-off rampways for the transport of large prefabricated structures. Their propulsion system is by twin shaft CPP propellers, powered by a pair of diesel engines, maximum rating 3218kW at 600/196 rpm.

The experiments with the air-lubrication system carried out in a variety of normal operating conditions over a two-year period confirmed an average 6% reduction in fuel consumption.

With a growing awareness in the industry that this new technology delivers on its fuel-saving promise, AIDA Cruises ordered MALS to be installed in its two new 125,000 gt cruise ships now under construction at MHI's Nagasaki Shipyard & Machinery Works. MHI say that the system is expected to reduce fuel consumption by 7% and will be the world's first such installation in a large cruise ship. Deliveries are scheduled for the spring of 2015 and 2016.

Air pipe – A pipe provided to equalize the tank pressure with the atmospheric one while the tank is being emptied or filled. Air pipes terminating on the open deck shall be fitted with approved air pipe heads. However, air pipes from the fuel oil settling and service tanks should be led to the funnel in order to eliminate the risk of water ingress due to a broken pipe or head.

*To meet requirements of the International Convention on Load Lines it is enough to arrange 760mm high air pipes on freeboard deck and 450mm height ones on **forecastle** and **poop**. However such standard approach is no more valid. Efficiency of many vessels depends on their damage stability characteristics: better damage stability allows higher permissible vertical centre of gravity. In order to improve damage stability of the vessel it is very important to arrange air pipes and vents as far as possible from ship sides and as high as reasonable.*



Photos: J. Babicz

Light, compact air pipe heads from WINTEB enable tank flushing (left) or tank sounding (right)

Air receiver, air reservoir – A pressure vessel for storing compressed air. Air receiver is built and tested similarly to a **boiler** drum.

Air resistance – That part of a ship resistance to motion that is due to the resistance of the air to above-water portion of the ship moving through it.

Air trunks – Parts of the hull that may either itself be used to conduct air or which contain air ducts as well as other lines (pipes, cables).



*Air receivers onboard the 4444 TEU container vessel
MSC FLORIDA designed and built by Gdynia Shipyard*

Airless spray – A method of paint spraying which does not use compressed air to atomise the paint.

Airless spray is a very fast and efficient method of application since the paint is forced into the surface at very high speed.

Alarm – A visual and/or audible signal indicating an abnormal situation.

Aldis lamp – A hand-held electrically operated signal lamp.

Alignment – An arrangement of different structural members in one straight line: alignment of **butt welds**, alignment of **stiffeners**, etc. Many ships have suffered when other design requirements have been assigned undue priority over structural alignment. See also **Shaft alignment**.

Alkyd resin – A synthetic resin made by a reaction of two chemicals in the presence of natural or processed oil.

Alleyway – Any corridor aboard vessel connecting one part of the **accommodation** to another part.

Allision – The act of striking or collision of a moving vessel against a stationary object.

Alloy flux – A flux which the alloy content of the weld metal is largely dependent on.

All-weld-metal test specimen – A test specimen with the reduced section composed entirely of weld metal.

Alternating current (AC) – Alternating current is a form of electricity in which the current alternates in direction (and the voltage alternates in polarity) at a frequency defined by

the generator (usually between 50 and 60 times per second, i.e., 50 – 60 hertz). AC was adopted for power transmission in the early days of electricity supply because it had two major advantages over direct current (DC): its voltage could be stepped up or down according to need using transformers, and it could be interrupted more easily than DC. Neither advantage is as relevant today as it once was because power electronics can solve both issues for DC.

Alternator – An **alternating current** generator. See also **Shaft alternator**.

Aluminium – A light metal of a good resistance to atmospheric corrosion. It is used as the base metal for light alloys.

Aluminium alloys – Aluminium alloyed with materials such as copper, manganese, silicon or magnesium, to improve their strength.

Aluminium brass – Brass containing up to 6% aluminium in order to improve resistance to corrosion.

Aluminium bronze – A copper aluminium alloy containing 4-11% of aluminium and other elements for particular properties. It is used for **propulsors**, valve fittings and other applications where corrosion resistance is important.

Ambient conditions – Parameters such as barometric pressure, engine room and seawater temperatures and relative humidity to be taken into account while designing ship's machinery. Usually the barometric pressure of 1000 millibars, an engine room temperature of 45°C, a sea water temperature 32°C, and relative humidity of 60% are used for ships with unrestricted service.

Ambient environment – Environmental conditions that the crew is exposed to during periods of work, leisure or rest.

Amidships –

1. A nautical term, which refers to the longitudinal centerline of a ship.

2. In ship construction amidships is in the middle of the **length** (L).

Ammeter – An indicating instrument used to measure electrical **current** flow.

Ammonia – Noxious, pungent gas, extremely soluble in water and alcohol. It is used as a **refrigerant**. Further Ammonia is used as feed stock in e.g. fertilizer production and several other industries.

Ammonia slip – Amount of unreacted ammonia emitted from a control equipment such as electrostatic precipitator, **selective catalytic reduction (SCR)** or selective non-catalytic reduction process.

Ampere – A standard unit for the measurement of electric current.

Amplification – The ratio of output to input magnitude in a device which is designed to produce an increased value output.

Amplitude – The maximum displacement of a varying quantity, measured from some datums.

Analogue components – Analogue components generate time-continuous outputs (volts, pressure, and so forth) to manipulate process inputs and which operate on continuous signals from instrumentation measuring process variables (position, temperature, and so forth).

Anchor – A heavy forging or casting shaped to grip the sea bottom, and by means of a cable or rope, holds a ship or other floating structure in a desired position regardless of wind and current. Different types are in use: stock-anchors, stockless anchors (SPEK or HALL type), High Holding Power (HHP) anchors, Super Holding Power (SHHP) anchors.

Anchor/mooring equipment of Bergesen's LNG tankers

Anchoring equipment is designed for temporary mooring a vessel within a harbour or sheltered area when the vessel is awaiting berth, etc. It is assumed that under normal circumstances a ship will use only one bow anchor and chain cable at a time.

High holding power (HHP) anchor – An anchor is approved as HHP anchor after it has proven, during 3 runs, in 3 soil types and for different weights, that the holding power is at least two times the holding power of a conventional anchor of the same weight. As soon as the predicate "High Holding Power" is obtained a weight reduction of 25% compared to the conventional anchor is allowed.

Super high holding power anchor (SHHP) – To obtain the predicate SHHP, the anchor must have a holding power of at least four times the holding power of a conventional anchor.

Anchor chain, anchor cable – A heavy chain used for holding a vessel at anchor. The total length of chain is to be divided in approximately equal parts between the two bow anchors. The inboard ends of the chain cables are to be secured to the ship's structure by means which enable, in case of emergency, an easy slipping of the chain cables to sea.



Photos: C. Spigarski

Spek anchor, note anchor pocket



Photo: J. Babicz

Spare anchor AC-14 type



Anchor chain

Anchor/mooring equipment of Bergesen's LNG tankers

Rauma Brattvaag has provided anchoring and mooring systems for 140,000m³ **LNG tankers** built by Daewoo for Bergesen ASA. Combined windlass/mooring winches, each with a **cable lifter** suitable for 114mm U2 chain and operated by a driving unit with two hydraulic motors.

The windlasses for these vessels are specially designed for deep sea anchoring, and the drive unit with two hydraulic motors, enables the anchor chain to be hoisted from a depth of 360m. The package also features seven two- and three-drum mooring winches, each with a hoisting pull of 30tonnes at 15m/min or 50m/min at slack rope.

All the mooring winches feature a gear transmission housed in an oil bath, split-type plain bearings, stainless steel-lined band brakes, and a facility for setting the brakes to 60% of the mooring line's breaking strength.

Anchor/mooring equipment of the shuttle tanker KNOCK WHILLAN

The ship is equipped with an electro-hydraulic combined anchor windlass/mooring winch. The **windlass** is a 49.5t capacity device rated at 9 m/min, and the mooring winch is 20t capacity device rated at 15 m/min with two drums and two sets. The remaining six sets of **mooring winches** are also electro-hydraulic devices. A single 250t escort tug hawser mooring system complements the winches.

The vessel has a pair of **OCIMF** standard 200t capacity bow **chain stoppers** and a single 500t North Sea model. A Maritime Pusnes offshore type **emergency towing** arrangement is fitted aft, with a Hyundai type arrangement forward.

Anchor/mooring equipment of the cruise liner ELATION

Low-noise anchoring and **mooring equipment** are valued by Carnival Cruise Lines, whose 70,400gt ELATION and PARADISE feature two sets of Rauma electric combined mooring winch/windlass units on the forward mooring deck. Each winch has one **split drum**, a **warping head** and a **cable lifter**, handling 84mm diameter anchor chain. Two 25t capacity mooring winches with two split drums and warping head are also mounted on the fore deck. On the aft deck there is a pair of combined mooring winches, each with two split drums and a mooring head, and a mooring winch with one split drum and a warping head.

Anchor pocket – A recess in the **bow** plating large enough to accommodate the anchor so that there is no projection outside of shell plating.

Anchor windlass trials – Each windlass shall be tested under working conditions after installation on-board to demonstrate satisfactory operation. Each unit is to be independently tested for braking, clutch functioning, lowering and hoisting of chain cable and anchor, proper riding of the chain over the chain lifter, proper transit of the chain through the hawse pipe and the chain pipe, and effective proper stowage of the chain and the anchor.

The mean hoisting speed is to be measured and verified, of each anchor and at least with 82.5m length of chain submerged and hanging free.

The braking capacity is to be tested by intermittent paying out and holding the chain cable by means of the brake application.

Anemometer – A device used to measure wind speed and direction relative to that of the ship.

Angle of flooding – Downflooding angle related to **intact stability** is the angle of heel at which the lower edge of openings in the hull, **superstructures** or **deckhouses** that cannot be closed weathertight immerse.

Air inlets to the Engine Room must be always open and the downflooding angle for the intact stability shall be calculated taking into account these openings. Some types of dangerous cargoes require continuous ventilation; in such cases it is necessary check the downflooding angle also for hold ventilation openings.

ANCHOR/MOORING EQUIPMENT



Photo: J. Babicz

Anchor/mooring equipment on the forecastle deck of 5300 TEU vessel

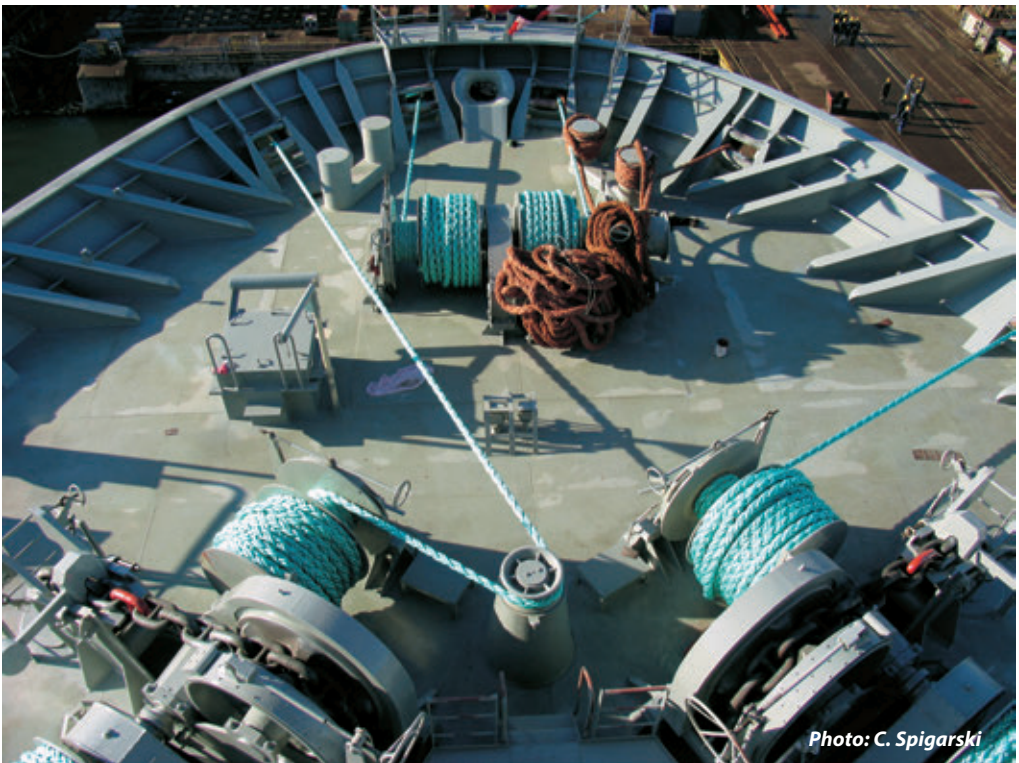

Photo: C. Spigarski

Anchor/mooring equipment on the forecastle deck of 4444 TEU vessel

Downflooding angle related to damage stability – The minimum heel angle where an external opening without watertight closing appliance is submerged.

Hold ventilation openings/fans are usually protected only by weathertight closures and these are openings to be taken into account for damage stability calculation.

Angle of entrance – The angle formed by the **centerline** of the vessel and the tangent to the design waterline at the forward perpendicular.

Angle of heel, heel – A steady angle of heel created by an external force, such as wind or waves.

Angle of list, list – A steady angle of heel created by forces within the ship. For example, when the ship is inclined due to her asymmetric construction, or by shifting a weight transversely within the ship. The list reduces of ship's stability. Therefore it is essential to keep the ship upright at all times by a symmetrical distribution of masses.

Angle of loll – The angle at which a ship with a negative initial **metacentric height** will lie at rest in still water. In a seaway, such a ship will oscillate between the angle of loll on SB and the one on PS. Depending upon external forces such as wind and waves a ship may suddenly flop over from PS to SB and then back again to PS. Such abrupt oscillation, different from a continuous roll, is characteristic for negative metacentric heights.

An angle of loll can be corrected only by lowering the centre of gravity, not by moving loads transversely. This can be done by moving weight downwards, adding water ballast in double bottom tanks or removing weight above the ship vertical centre of gravity.

Where empty ballast tanks are available these will afford the simplest means of lowering the ship's centre of gravity. The correct procedure is to add ballast on the low side of the ship. The first effect will be to increase the angle of heel and to cause a loss of stability due to the free surface of the water, but this effect is soon cancelled and the angle of heel will rapidly decrease.

Angle of repose – The angle between the horizontal line and the side of the cone formed when the granular materials as grain, coal, sand or ores are poured onto a flat surface. The angle of repose of most grain loads ranges between 20° and 22°, but for barley it reaches 46°. The angles of repose for ores range between 34° for copper from Norway, and 60° for copper from Peru.

Annealing – The type of steel heat treatment. The steel is heated to around 850-950°C and then is cooled slowly either in a furnace or in an insulated space. Softer, more ductile steel that that in the normalised condition is produced.

Annunciation – An audible signal indicating a condition or system state (usually of an emergency or abnormal nature).

Anode – Positive terminal of an electrolytic cell at which corrosion occurs, a piece of metal fixed to steel to provide **cathodic protection**.

Anti-exposure suit – Anti-exposure suits are similar to **immersion suits**, but there are a few differences. They must provide at least 70 Newtons of buoyancy and be made of material that reduces the risk of heat stress during rescue and evacuation operations. Anti-exposure suits are provided with a **lifejacket light** and whistle and must be capable of turning a person in the water from face-down to face-up in not more that five seconds.

Anti-fouling paint – A paint containing agents for preventing the adhesion and growth of organisms on the hull.

Anti-fouling system

Anti-fouling system – A coating, paint, surface treatment or device that is used on a ship to control or to prevent the attachment of unwanted organisms.

Anti-heeling systems – During loading and discharging the ship's heel has to be kept to minimum to avoid jamming of containers in cell guides, twisting of **ramps** or damage of rolling cargo. Anti-heeling systems are pump or air blower activated systems developed to compensate ship's heel. See also **Intering™ Anti-heeling Systems**.

Anti-lift bolt – A device, like a cleat, which prevents a hatch cover from lifting up.

Anti-polishing ring – A ring installed in the upper end of the cylinder in order to remove deposits from the piston top land and ensure proper cylinder function, no bore polishing, stable lube oil consumption and low wear of the liner.

Anti-Rack Spacer stowage system – The containers are connected longitudinally with so called "anti-racking spacers", thus creating one 40-foot container out of two 20-foot ones. This system avoids all side supporting, and there are no foundations or rails in the longitudinal **bulkheads**. See also **Mixed stowage** and **Side support stowage system**.

Anti-rolling devices – Bilge keels, fin stabilisers. See **Roll stabilisation**.

Anti-roll tanks, tank stabilisers – Transverse tanks installed at suitable height and distance from the ship center line in order to generate anti-rolling forces by phased flow of large volume of liquid. Fluid transfer may be done by open flume or from and to wing tanks connected by cross ducts. See also **Intering™ tank stabilisation systems**.

Passive anti-roll tanks require large volumes of liquid in order to absorb a significant amount of roll energy. There are two general types of passive anti-roll tanks: the free-surface tank and U-tube tank.

Appendages – The portions of a vessel extending beyond the main hull outline including such items as **rudder, propellers, struts, shafts**, shaft bossings, sonar domes and **bilge keels**.

Approved equipment – Equipment of the design that has been tested and approved by an appropriate **authority** such as a government department or **classification society**. The authority should have certified the equipment as safe for use.

AQUARIUS ballast water treatment plants

Recognizing that no one solution is suitable across all ship types Wärtsilä Water Systems designed two technology choices for Ballast Water Management: AQUARIUS® UV and AQUARIUS® EC. Wärtsilä AQUARIUS® UV is suitable for vessels with small to medium pump capacities. Whereas Wärtsilä AQUARIUS® EC is better suited for vessels with larger pump capacities.

The AQUARIUS® UV system is a two stage approach with filtration followed by disinfection using ultraviolet light. Upon uptake, seawater is first passed through an automatic backwashing filter (1st stage). The filtered seawater then passes through a UV chamber (2nd stage) where ultra-violet light is used to disinfect the water before entering the ballast tank. On discharge, water from the ballast tank is pumped through the UV chamber for a second time to complete the disinfection process prior to discharge. The filter is not used during discharge. Wärtsilä AQUARIUS® UV IMO Type Approval was awarded by the Netherlands administration during December 2012, and was followed by USCG Alternate Management System (AMS) in October 2013.

The AQUARIUS® EC system is a two stage approach with filtration and electro-chlorination. Upon uptake the sea water is first passed through a automatic backwashing filter (1st stage),

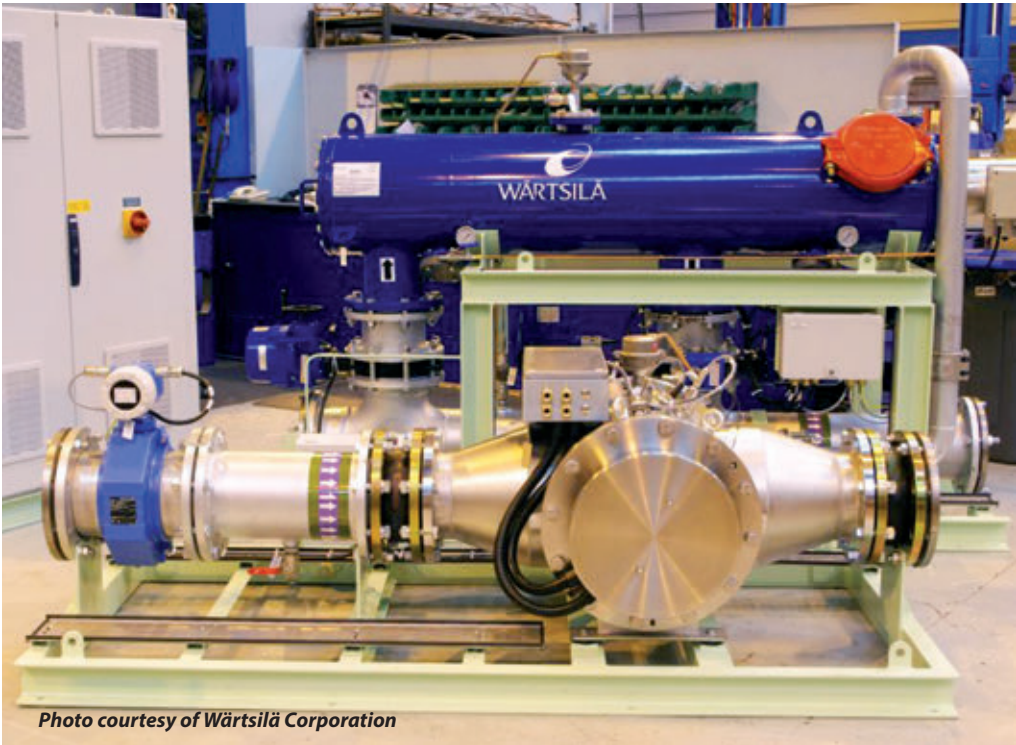

Photo courtesy of Wärtsilä Corporation

Aquarius-UV

and then filtered water passes through a static mixer, where disinfectant generated from the side stream EC Cell Module (2nd stage) is injected to ensure a maximum dose of 10ppm in the treated ballast water prior to entering the ballast tank. At discharge, water from the ballast tanks by-passes the filter and residual concentration of disinfectant is monitored. If required, treated ballast water is neutralized, ensuring compliance with MARPOL discharge limits.

Wärtsilä AQUARIUS® EC IMO Type Approval was awarded by the Netherlands administration during December 2013.

The modular approach provides maximum flexibility during system design and installation where key components are positioned to suit available space, a major advantage when considering retrofit projects. Retrofit installations can be carried out either during dry docking, at the quayside or whilst the ship is in operation, thus minimizing any impact on ship downtime.

Arbitration – A method of settling disputes by one or more arbitrators. Quicker and less expensive than taking a case to court.

Arc welding – Arc welding is the fusing of two metals using heat produced by an electric arc formed between them.

Archimedes' principle and ship equilibrium

A body immersed in fluid is subject to an upwards force equal to the weight of the fluid displaced.

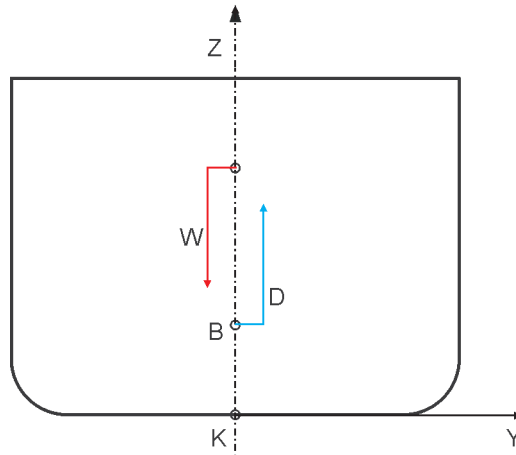

Archimedes' principle

For the ship to float, it must displace its own weight of water: $W = D = V \times \text{water density}$, where: **W** – Weight of the ship, **D** – Displacement, **V** – Volume of displacement

The **displacement** of a ship, **D**, is defined as the number of tones of water it displaces. The volume of displacement, **V**, is the underwater volume of a ship afloat i.e. the volume below the **waterline**.

G – Centre of gravity, **B** – Centre of buoyancy

Two vertical forces always act upon the ship when rest in still water: its weight, **W**, acting downwards through the centre of gravity, **G**, and the displacement, **D**, acting upwards through the centre of **buoyancy** **B**. The weight and the displacement are equal in magnitude. For the ship in equilibrium the sum of their moments must be zero. Therefore the ship will **heel** and **trim** as long as centres of gravity and buoyancy will be in the same vertical line.

ARCS Hydrographic Chart Raster Format – A type of electronic navigational chart (ENC) format.

The United Kingdom Hydrographic Office (UKHO) publishes the digital raster charts in Hydrographic Chart Raster Format (HCRF). These raster charts are scanned from traditional paper charts and are realized as a set of one or more panels. The chart itself is always the panel 0 and each inset plan represents an additional panel. Some panels may even be split into sub-panels because of mathematical problem encountered by the dateline or the coverage of a wide latitude range. Following the notices to mariners for paper charts the UKHO publishes weekly updates, which can be applied to the ARCS chart.

Argon – An inert gas used to shield the molten metal during argon arc welding.

Arrangement of chocks and bitts for transit of Panama Canal – A vessel passing through the locks shall normally be assisted by locks locomotives using steel towing wires. Article 59 of the Regulations on Navigation in Panama Canal Waters (www.pancanal.com) defines the requirements regarding construction, number, and locations of the chocks and bitts. Generally all vessels, except a vessel not requiring locomotives, shall be fitted with a double **chock** right in the **stem**, and another double chock right in the **stern**, and each shall be have two accompanying pairs of heavy bitts.

BASIC ARRANGEMENTS OF CHOCKS FOR PANAMA CANAL

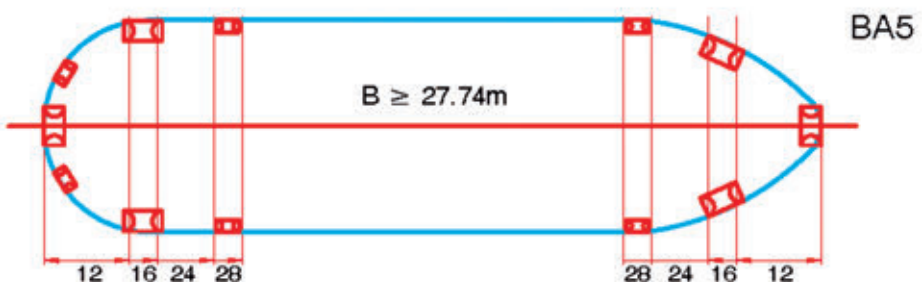
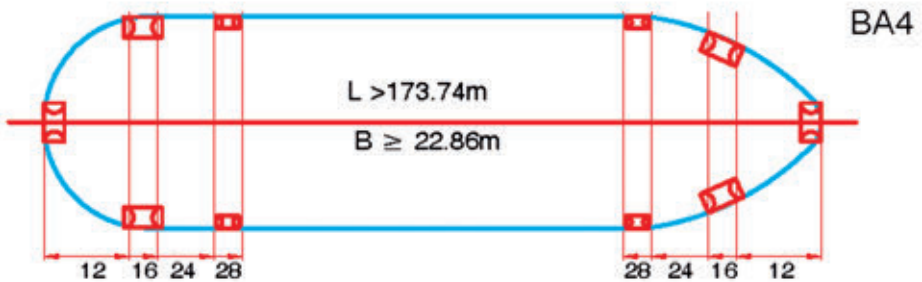
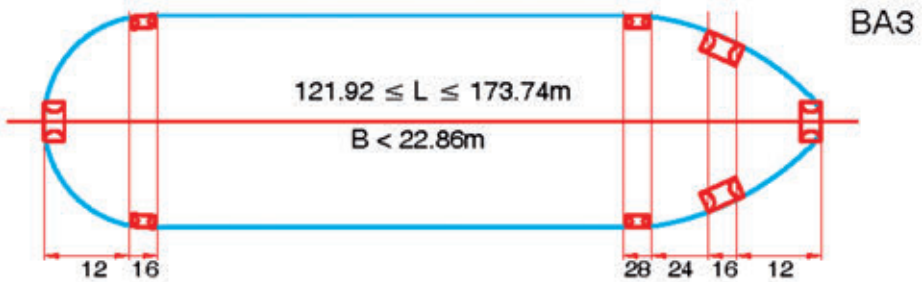
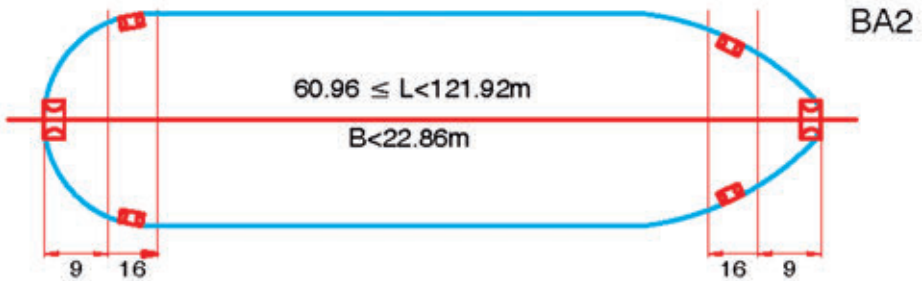
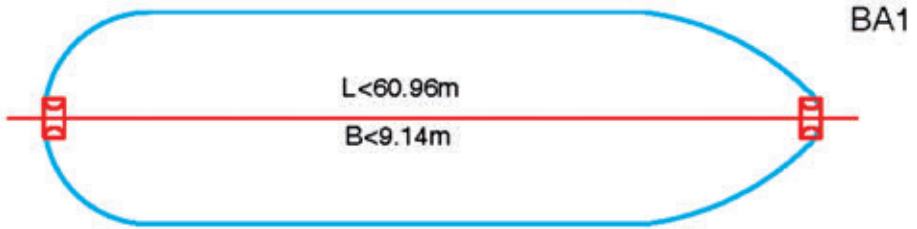

Arrest

Vessels not exceeding 22.86m in beam can be provided with two single chocks, placed not more than 2.5m abaft the stem and no more than 3m off the centre line, instead of a double chock right in the stem. An aft double chock required right in the stern can be replaced by two single chocks located not more than 3m forward of the stern and 3m off the centre line.

Vessels exceeding 22.86m in beam can be provided with two double chocks, placed not more than 2.5m abaft the stem and no more than 3m off the centre line, instead of a double chock right in the stem. An aft double chock required right in the stern can be replaced by two double chocks located not more than 3m forward of the stern and 3m off the centre line.

All vessels with a maximum beam of 27.74m or more, in addition to the double chock at the stern, shall have two symmetrically spaced single chocks at the stern, not less than 3m, nor more than 6m from the centre line.

Detailed requirements of additional double chocks, single chocks and bitts depend on ship's length and beam. Additional double chocks shall have a pair of heavy bitts, and each single chock shall have an accompanying bitt.

Arrest (marine insurance) – By "Arrest" is meant the detention of a ship because of some infringement of regulations, either port or national. When a maritime lien is to be exercised the ship may also be "arrested". Such a lien may arise when the ship is the subject of a salvage award. Arrest may also arise in the event of collision disputes. The policy does not cover any of these.

Asphalt carrier ASPHALT SEMINOLE

Built by Kraljevica Shipyard, Croatia, the ASPHALT SEMINOLE has been designed for world-wide service transporting cargoes requiring to be carried at temperature up to 250°C, including asphalt, bitumen, coal tar, coaltar pitch, coaltar naphta solvent and wood creosotes. The hull is laid-out with a wide double skin featuring large topside wing tanks, the line of which extends through the upper deck to form a trunk joining with a long forecastle. At midships the trunk is carried to the ship's side in way of the manifolds, positioned above a pump room containing 2x400m³/h and 1x150m³/h hydraulic cargo pumps arranged to handle two grades of cargo simultaneously.

Within the cargo space, three holds are formed, each fitted with an independent prismatic cargo tank-block constructed of AH32 shipbuilding steel. No1 block (forward) contains a single tank, with No2 sub-divided into four tanks and No3 forming three tanks. All eight tanks can be used to carry heated or unheated products. Anti-rolling, pitching and floating keys support the blocks, and vertical "sandwich" supports (Feroform F3637 and Epocast 36 epoxy resin) are also provided. Insulation of blocks is by means of Rockwool mineral wool covered by aluminium foil. Water ballast is carried in the double-hull wing and bottom tanks, with bunkers carried in tanks forward and aft of the cargo space.

Two composite boilers are fitted to supply engine room needs and for heating bunker fuel, with two thermal oil heaters, each having an output of 1,200,000 kcal/h, satisfying the total heating load and giving thermal-oil temperature for cargo heating of 290°C (supply), reducing to 260°C on return, with oil circulation assisted by two 83m³/h pumps. The heating system is designed to maintain 250°C with seawater and ambient temperature conditions of 10°C and 0°C, respectively. In addition, cargo temperature can be raised by 10°C in one tank in 24hours under the same external conditions.

Assembly

The vessel is powered by a Wärtsilä 8L32 diesel engine developing 4000kW at 750 rpm and flexibly coupled to a gearbox arranged to drive an alternator producing 1380kVA. Wärtsilä also supplied the shaft line and CP propeller giving a service speed at 85% MCR/15% sea margin of 13.4knots. Additional electrical supply comes from two Wärtsilä diesel alternator sets having an output of 1380kVA. The bow thruster is a 360kW unit, and a Becker flap rudder is fitted.

Length, oa: 108.50m, Length, bp: 99.90m, Breadth, mld: 18.60m, Depth to main deck: 10.60m, Draught design/maximum: 6.75/8.34m, Lightweight: 3660t, Deadweight design/maximum: 6494/9230dwt, Gross tonnage: 6292, Propulsion power: 4000kW, Service speed at 85% MCR, 15% sea margin: 13.40 knots.

Assembly – A large three-dimensional structure of plating and sections used in the construction of a ship.

Assembly station – Place on deck, in mess rooms, etc., assigned to crew and passengers where they have to meet according to the muster list when the corresponding alarm is released or announcement made.

Astern –

1. Behind a vessel.
2. Backward; in a reverse direction. If a vessel moves backwards it is said to move astern, opposite to ahead.

As-welded – The condition of weld metal, welded joints, and weldments after welding, but prior to any subsequent thermal, mechanical, or chemical treatments.

Asymmetrical stern – A special configuration of the **afterbody** lines used to compensate for the side **thrust** generated by a **propeller** and make a more equal water flow into the propeller.

Athwartship – Across the ship, at right angles to the fore-and-aft centre-line. Said of cargo stowed in this way, as opposed to length-wise.

Atomization – Subdivision of a material into its smallest particles, such as fuels reduced to a fine spray mist by diesel engine injectors.

Atomizer – A nozzle arrangement through which fuel oil is forced under pressure in order to leave as a fine spray i.e. atomized.

Atriums – Atriums are public spaces within a single main vertical zone spanning three or more open decks, (SOLAS).

Attenuation – A reduction in current, voltage, or power due to transmission. The opposite of **amplification**.

Austenite – One of three possible phases of iron and carbon atoms in carbon steel, characterised by a face-centred cubic unit. See also **Ferrite** and **Cementite**.

Auto container – Container equipped for the transportation of vehicles.

Auto-ignition – The ignition of a combustible material without initiation by a spark or flame, when the material has been raised to a temperature at which self-sustaining combustion occurs.

Automatic Identification System (AIS) – A novel radar-based system displaying ship's unique identification numbers alongside the **radar** vectors. AIS equipment consists of a central unit that collates information from the ship's navigation systems with pre-programmed information about the ship's identity and dimensions and additional information such as voyage details. The information is transmitted automatically to other ships and coastal VTS by way of transponder operating in the VHF marine band. The new

AIS requirements have entered into force under amendments to the Solas Convention on July 1, 2002, when new ships of 300 gross tonnage and over engaged in international voyages will have to install the device.

Automatic pilot, autopilot – Automatic control system used for automatic **navigation**. The system can sense the difference between the ordered course of the ship and the actual course and will cause the **rudder** to move to an angle proportional to this error. The autopilot keeps the vessel on the correct heading without the **helmsman's** intervention.

Automatic radar plotting aids (ARPA) – Automatic radar plotting aids are essentially utilized to improve the standard of collision avoidance at sea. Primarily designed as anti-collision **radar**, the ARPA technology removed the chore of plotting targets manually on a reflection plotter or separate plotting aid. The system is able to acquire automatically and constantly monitor number of targets, plot their speeds and courses, present these as vectors on the display screen, updated with each sweep of the antenna, and calculate their closest points of approach to own ship and the time before that will occur.

Automation – Automation can be defined as an apparatus, process, or system that is self-acting or self-regulating, generally through the employment of mechanical or electrical devices that replace human observation, effort, and decision-making.

Closed-loop control – Self-regulating control system. Such a system maintains the desired operation by comparing the controlled variable to the set point. The difference between actual and desired outputs creates an error signal. That error signal is fed back to the control elements, which act upon it to reduce the error signal within an acceptable tolerance band. An example of such control is the regulation of the voltage and frequency of the ship's electrical generators under varying load conditions.

Open-loop control systems – Open-loop control systems do not employ the feedback principle. Such systems are self-acting but not self-regulating and are used in automated systems where system operation can be predicted with a high degree of certainty.

Automoooring systems – Unconventional automatic mooring systems designed to reduce harbour time for ferries. The mooring operation is controlled automatically from the wheelhouse reducing personnel requirements. See also **IRONSAILOR**.

Rod-type mooring system developed by Swedish company NORENT AB incorporates a mooring arm and hook attached to a telescopic outer arm, which extends to its outer position until it hooks on to a pre-erected quayside bar and the determined holding force is achieved. Only when the vessel is in position alongside the quayside fender and the linkspan, can the master activate the mooring operation remotely from the bridge.

Auxiliary blowers – On two-stroke diesels, electrically-driven auxiliary blowers are usually provided because the exhaust gas-driven turbo-charger cannot provide enough air at low engine speed. Auxiliary blowers are internal parts of the main engine.

Auxiliary boiler – A boiler that supplies steam for essential auxiliary purposes but not for main propulsion.

Auxiliary machinery, auxiliaries – A term applied collectively to all machinery and apparatus forming the nonpropulsive equipment of a ship.

Deck auxiliaries, deck equipment, deck machinery – All machinery used for working the vessel and handling the cargo: winches, windlass, steering gear, cranes, etc.

Engine room auxiliaries – All machinery in the engine room which assist in the working of the propulsion plant: coolers, heaters, pumps, separators, etc.

Auxiliary Propulsion Drive, take-home system – Propulsion system that consists of a **medium-speed diesel engine**, a reduction gear with Power Take In (**PTI**) drive, a **shaft generator**, and CP **propeller**. In normal operation at sea the CP propeller is driven by the main engine and a part of the engine power can be supplied to the shaft **generator** to produce electricity. When the main engine is out of operation, the ship can be propelled by using the shaft generator as an electric motor, supplied by the diesel generators.

AUXPAC – The WÄRTSILÄ® Auxpac is a generating set designed for auxiliary power generation in commercial type vessels. It is a pre-commissioned standard package that ensures the availability of electrical power in sufficient quantity as and when it is needed.

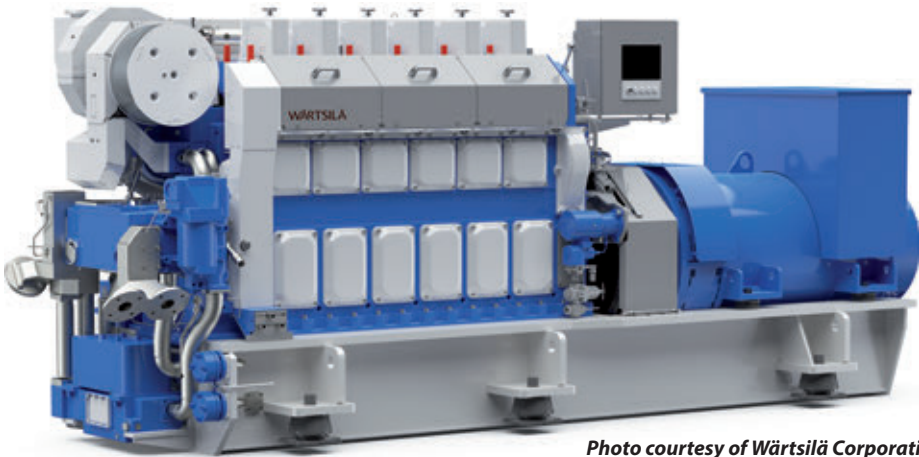

Photo courtesy of Wärtsilä Corporation

AUXPAC

Gensets are based on the Wärtsilä engine types 20 and 26 and Fenxi and AVK generators. The lower power range, 520W4L20 - 1700W9L20, is based on the W20 engine and the higher power range, 1800W6L26 - 2850W9L26, is based on the W26 engine.

Average –

1. This is the marine insurance term for a partial loss. Particular charges are not to be included when calculating average.
2. The numerical result obtained by dividing the sum of two or more quantities by the number of quantities.

Average adjusters – In general, average affairs adjusters are entrusted with the task of apportioning the loss and expenditure over the parties interested in the maritime venture and to determine which expenses are to be regarded as average or general average.

Aweigh – Description of the situation when the **anchor** has just been lifted from the seabed.

Awnings – Sheets of canvas or similar material, erected above weather decks to provide shade and shelter.

AZIPOD (Azimuthing Podded Drive) – Azipod is the electrically driven **propulsor** with an AC motor incorporated in a streamlined azimuthing pod unit directly driving a fixed-pitch **propeller**. The motor is controlled by a frequency converter, which produces full nominal torque in either direction over the entire speed range, including standstill. Over torque can also be utilized e.g. in ice-going vessels. Each Azipod propulsion system is individually designed and optimized to achieve maximum performance.

The idea of placing an electric motor inside a submerged propulsion pod has been around for some time but it was not until the late 1980s the Kvaerner Masa-Yards teamed



with ABB Stromberg Drives to develop the first practical podded main propulsion system. The 1.5MW Azipod propulsion unit was installed on the waterway service vessel, SEILL delivered in December 1990. In 1994 the existing propulsion installation of the 16,000dwt Arctic tanker UIKKU was replaced by a cycloconverter-controlled 11.4MW Azipod drive. Sea trial results were encouraging: the same trial speed at the same shaft speed was achieved as in the original trials, however, remarkable improvements were found in the manoeuvrability. See also **Electric podded propulsors**.

For more information visit www.abb.com/marine FREEDOM OF THE SEA, the largest cruise ship in the world, is provided with three (two azimuthing, one fixed) ABB 14MW cycloconverter-controlled Azipod propulsion units. This arrangement was chosen to provide excellent manoeuvrability and less vibration operation. For the shipyard, fitting a pod drive system is a single lift operation instead of installing and checking thrust bearing, shaftlines, sterntubes, seals and possibly gearboxes.

Compact Azipod – The new propulsion system with a power range from 400kW up to 5MW aimed at ferries, dredgers and offshore vessels. The unit comprises four distinct parts: the steering gear; the strut with pod tail cone; the motor section; and the nose cone/propeller. Unlike the single or double wound AC motor of conventional Azipod concept, the Compact Azipod unit incorporates a **permanent magnet synchronous motor** and therefore has no cooling on the rotor, while the stator is cooled by convection to the surrounding seawater. A frequency **converter** provides accurate speed and torque control.

Among vessels provided with Compact Azipod there are:

- HMS ECHO & HMS ENTERPRISE, 2x1700kW,
- Platform Support Vessel VIKING AVANT 2x3000kW,
- UT 745-E Platform Supply Vessel NORMAND FLOWER, 2x2300kW.

Picture courtesy of ABB

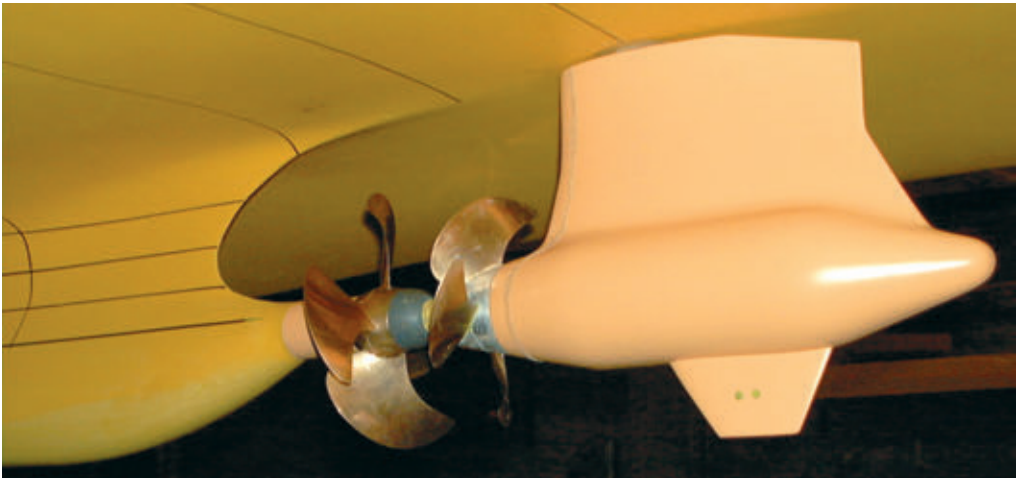

Hybrid Propulsion. Photo courtesy of Wärtsilä Corporation

CRP Azipod – The combination of the shaft-driven main **propeller** and the podded propulsor located on the same axis, but without any physical connection. The arrangement works as the contra-rotating propellers and is said to give an improvement of over 10% in hydrodynamic efficiency for an ultra-large containership. See also **CRP-Azipod propulsion of the ferry HAMANASU**.

A study by ABB and South Korean shipbuilder Samsung evaluated the technical and economic merits for single-screw, twin-screw/twin-skeg and CRP Azipod solutions for propelling ultra-large containerships. The total propulsion efficiency calculations gave the CRP Azipod advantages of 4.9 percent over the single screw and 9.1 percent over the twi-screw/twin-skeg options.

B

Backgouging – The removal of weld metal and base metal from the weld root side of a welded joint to facilitate complete fusion and complete joint penetration upon subsequent welding from that side. See also **Gouging**.

Back haul – The return movement of a means of transport providing a transport service in one direction.

Backpressure – The pressure existing on the exhaust side of a system, e.g. the pressure opposing the motion of an engine piston during its exhaust stroke.

Backing – A material or device placed against the backside of the joint, or at both sides of a weld in electroslag and electrogas welding, to support and retain molten weld metal. The material may be partially fused or remain unfused during welding and may be either metal or nonmetal.

Backing pass, backing weld – A weld pass made for a backing weld.

Backing ring – Backing in the form of a ring, generally used in the welding pipe.

Back-up navigator – Any individual, generally an officer, who has been designated by the vessel master to be on call if assistance is needed on the **bridge**.

Baffle plate – A plate used to direct fluid flow, e.g. the hot gases in a **boiler** furnace or the oil in a sump tank.

Bagged cargo – Various kinds of commodities usually packed in sacks or in bags, such as sugar, cement, milk powder, onion, grain, flour, etc.

Balance ratio – The ratio, of the blade area situated forward of the **rudderstock** to the total rudder blade area.

Bale capacity, bale cubic – The cubic capacity of a cargo hold measured to the inside of the frames or cargo battens.

Ballast – Any solid or liquid weight placed in a ship to increase the **draught**, to change the **trim**, or to regulate the **stability**. Ballast water is allocated during the voyage to accommodate changes in the distribution of cargo and consumables, and in response to operational requirements such as draught limitations.

Clean ballast – The ballast in a tank which, since oil was last carried therein, has been so cleaned that effluent there from if it were discharged from a ship which is stationary into clean calm water on a clear day would not produce visible traces of oil on the surface of the water or on adjoining shorelines or cause a sludge or emulsion to be deposited beneath the surface of water or upon adjoining shorelines. If the ballast is discharged through an oil discharge monitoring and control system approved by the **Administration**, evidence based on such a system to the effect that the oil content of the effluent did not exceed 15 parts per million shall be determinative that the ballast was clean, notwithstanding the presence of visible traces (MARPOL).

Segregated ballast – The ballast water introduced into a tank which is completely separated from the cargo oil and oil fuel system and which is permanently allocated to the carriage of ballast or to the carriage of ballast or cargoes other than oil or noxious substances (MARPOL).

Ballast movement – A voyage or voyage leg made without any paying cargo in a vessel tanks. To maintain proper stability, trim, or draught, seawater is usually carried during such movements.

Ballast pumps – Electric-driven pumps, usually vertically mounted and fitted with separate motor-driven priming systems. Close-coupled designs have the pump rotor mounted on an extended motor shaft. This can cause difficulties when there is a need to open up the pump, as the motor may also have to be dismantled to gain access.

With owners expecting to shorten port turn round times; the need to get the ballast in or out of the tanks can take on a sense of urgency. Container ships are case in point. With containers stacked perhaps six high they cannot leave port until the ballasting is correct. This means that ballast pumps have to move impressive amounts of seawater.

If the operator says the ballast tanks have to be filled or emptied in a certain time, it is possible to look at this simplistically and divide their volume by the time to calculate the rate. However, as the tank empties, the head will reduce, and so will the effective flow rate. This in turn means the safety margin built in by the pump manufacturer is reduced, and friction losses in the pipework can take the flow out of specification.

A priming system with an adequate air-handling capacity is another important need. The pump/priming system not only has to contend with the depth of the tanks in the double bottom but also with the height of the pump above the tanktop. Air ejectors have limited capacity, so for the larger pumps separate motor driven pumps are required.

Ballast system – Piping and pumping system arranged so that water can be drawn from any ballast tank or the sea and discharged to any other ballast tank or the sea.

Ballast tank – Watertight compartment for holding water ballast.

Ballast Water Discharge Requirements

1. **Ballast Water Convention, 2004** -The International Convention for the Control and Management of Ships' Ballast Water and Sediments, 2004. The convention calls for ships greater than 400GT to conduct ballast water exchange or treatment in accordance with IMO regulations.
2. **USCG Ballast Water Program** – Rules and regulations for the management of ballast water in United States Waters, with a discharge standard in-line with IMO Ballast Water Conventions, 2004. Ballast Water Management Systems are to be tested and approved by the USCG for use on vessels transiting US Waters. Detailed information can be found at USCG Homeport, and regulation CFR 33 Part 151.
3. **USCG Alternate Management System (AMS)** – An interim ballast water management system recognition program, whilst systems are tested and Type Approved under the USCG regulations. Accepted AMS are Type Approved by a foreign administration pursuant to the standards set forth in the International Maritime Organization's International Ballast Water Convention, 2004, and meeting all applicable requirements of U.S. law, and which is used in lieu of ballast water exchange. The list of AMS accepted BWMS can be found at USCG Homeport.
4. **US EPA Vessel General Permit (VGP 2013)** – Part of the Nation Pollution Discharge Elimination System (NPDES) program under the Clean Water Act (CWA) containing rules and regulations for the management of ballast water in United States Waters.

Ballast water exchange at sea – The practical method to minimize the introduction of unwanted organisms from the discharge of ballast water. The exchange procedure shall be carried out in an "open ocean condition" at least 200 nautical miles from the nearest land and in waters at least 200 metres in depth. It can be accomplished by either the

sequential empty-refill method, by flow-through method or by dilution method whereby tanks are overfilled by pumping in additional water. Due to limited biological efficiency the ballast water exchange at sea is to be regarded as an interim measure.

Flow-through method – This method involves pumping open-ocean water into a full ballast tank. Ballast equal to approximately three times the tank capacity must be pumped through the tank to achieve 95% effectiveness in eliminating aquatic organisms. Applying the flow through method does not alter the **stability**, stress, and ship attitude.

Sequential method – This method entails emptying ballast tanks completely and refilling with open-ocean water. During ballast water exchange sequences there may be times when, for a transitory period, the criteria for propeller immersion, minimum draught or bridge visibility cannot be met. Emptying of certain tanks may lead to major reduction of **stability**, higher stresses, high sloshing pressures and increased probability of **bow slamming**.

Further reading: *MSC.Cir. 1145 Precautionary advice to masters when undertaking ballast water exchange operations*, *ABS Advisory Notes on "Ballast Water Exchange Procedures"* – can be downloaded from www.eagle.org

Ballast water exchange standard D1 – Ships performing ballast water exchange shall do so with an efficiency of 95% of ballast water. For ships exchanging ballast water by the flow-through method, pumping through three times the volume of each ballast water tank will be considered to meet the standard described. Pumping through less than three times the volume may be accepted provided the ship could demonstrate that at least 95% exchange is met.

Ballast water management – Various measures to prevent, minimize and ultimately eliminate the risk of introduction of harmful marine organisms within ballast water. Ballast water management includes the **ballast water exchange at sea** as well as the **ballast water treatment** by mechanical, physical, chemical or biological processes, either singularly or in combination. Compliance with the **ballast water performance standard** (regulation D-2 of the BWM Convention) seems to be achievable only by use of a **Ballast Water Treatment System**.

Ballast Water Management Plan – Ships of 400 gross tonnes and above are required to have on board and implement a Ballast Water Management Plan approved by Administration. The BWMP is specific to each ship and includes a detailed description of the actions to be taken to implement the Ballast Water Management requirements and supplemental Ballast Water Management practices.

Ships must have a Ballast Water Record Book to record when ballast water is taken on board, circulated or treated for Ballast Management purposes, and discharged into the sea. It should also record when ballast water is discharged to a reception facility and accidental or other exceptional discharges of ballast water.

Further reading: *IMO Resolution MEPC 127 (53) Guidelines for Ballast Water Management and Development of Ballast Water Management Plans*

Ballast water performance standard D2 – Ships conducting ballast water management must discharge fewer than 10 viable organisms per cubic metre that are greater than or equal to 50 micrometers in minimum dimension and fewer than 10 viable organisms per millilitre that are less than 50 micrometers in minimum dimension and greater than or equal to 10 micrometers in minimum dimension; and discharge of the indicator microbes must not exceed the specified concentrations.

Ballast water treatment

The indicator microbes, as a human health standard, include, but are not limited to:

1. Toxicogenic vibrio cholerae (O1 and O139) with less than 1 colony-forming unit (cfu) per 100 millilitres or less than 1 cfu per 1 gram (wet weight) zooplankton samples.
2. Escherichia coli – less than 250 cfu per 100 millilitres.
3. Intestinal enterococci – less than 100 cfu per 100 millilitres.

Ballast water treatment – Any method to kill, remove or render infertile, harmful or potentially harmful organisms within ballast water.

Ballast Water Treatment Systems (BWTS) – Ballast Water Treatment System (BWTS) is a system designed to remove and destroy/inactive biological organisms (zooplankton, algae, bacteria) from ballast water. Ballast water treatment is still evolving technology with an ever-growing number of manufacturers. This means that there is limited in-service experience for the systems being offered and there is a general understanding that no single system is suitable for all ship types. See also **AQUARIUS ballast water treatment plants**.

Descriptions of numerous treatment systems can be found in the ABS notice “Ballast Water Treatment Advisory”

Ballasting – The procedure during which seawater ballast is introduced in specific tanks to achieve a desired stability, draught and trim.

Balljoint connection over the bow – A special link between a floating pipeline and hopper dredger.



Baltic and International Maritime Council (BIMCO) – A commercial shipping trade organisation headquartered in Copenhagen. BIMCO is one of the largest international organisations of ship owners in the world. Homepage: www.bimco.dk, email: mailbox@bimco.dk

Bar – A unit of pressure equal to 100 000 Pascal (14.5 PSIG).

Bare boat charter – A charter in which the bare ship is chartered without **crew**. The **charterer** for a stipulated sum takes over the vessel for a stated period of time, with a minimum of restrictions. The charterer appoints the master and the crew and pays all running expenses.

Barge – A flat-bottomed craft of full body, applied for the transportation of bulky freight such as coal or lumber, sand, stone, and so on, usually without engines or crew accommodation. Barges can be lashed together and either pushed or pulled by **tugs**.

Barge aboard catamaran – A way of loading cargo into large barges and then in turn loading the barges into a ship.

Barge carriers – Ships designed to carry either barges or containers exclusively, or some variable number of barges and containers simultaneously. Currently this class includes two types of vessels, the **LASH** and the **SEABEE**.

Barnacle – A small, primitive sea animal with a calcareous shell which in its adult form lives attached to some alien object, such as a ship hull, wharf piles, and the like.

Barometer – An instrument used to measure atmospheric pressure.

Barred speed range of the diesel engine – Engine speeds that create harmful torsional **vibration**. The operation within the barred range is to be avoided.

Barrel – Measure of oil. There are 7.1 barrels of oil in one ton. Each barrel is approximately 159 litres.

Base line – A horizontal line drawn along the top edge of the **keel** from midships.

Base number (BN) – Measure of a lubricant's reserve alkalinity. It is measured in milligrams of potassium hydroxide per gram (mg KOH/g).

Basic design, also initial design – That part of the overall ship design process, which commences with design concept and terminates when there is reasonable assurance that the major features have been determined with sufficient dependability to allow the development of contract plans and specifications.

Batch – A collection of products or data, treated as one entity with respect to certain operations e.g. processing and production. For example the quantity of paint manufactured at one time in a single vessel and identified by a batch number.

Battening device – A device fitted between a hatch cover panel and the coaming which forces the cross joint together.

Battens – Members protruding from the inside walls of a vessel hold or a (thermal) container to keep away the cargo from the walls to provide an air passage. They may be integral with the walls, fastened to the walls or added during cargo handling.

Bauxite – The raw material for the manufacturing of aluminium; it stows at 0.7-1.1 m³/t.

Bay –

1. A vertical division of a vessel from **stem** to **stern**, used as a part of the indication of a stowage place for containers. The numbers run from stem to stern; odd numbers indicate a 20-foot position, even numbers indicate a 40-foot position.
2. The area between adjacent transverse frames or transverse bulkheads.

BC Code – see **Code of safe practice for solid bulk cargo**.

Bcf – Billion cubic feet, a unit measurement for large volumes of gas. 1 Bcf is approximately 28.32 million m³.

Beacon – A conspicuous mark used as a guide to mariners, either a landmark, erected on an eminence near the shore, or a mark moored or driven into the bottom in shallow water.

Beam –

1. A prismatic section with one dimension significantly larger than the others, that is subjected to bending loads. For example: an athwartship member supporting a portion of a deck.

Cross-tie beam – A large transverse member connecting a longitudinal bulkhead to the side shell structure within a cargo hold or tank, thereby increasing the transverse stiffness of the hull structure and providing additional support to the attached members.

2. The width of a ship, also called **breadth**.

Bearing – A common item in any mechanical system where two parts move relative to one another. A bearing enables the transfer of forces with a minimum of frictional losses.

Bearing pads – Support pads installed on the hatch **coaming** in order to transfer the weight of the cover, and any cargo it may be carrying, to the ship hull while allowing for relative movement between the cover and the hatch coaming. Bearing pads must also maintain the correct compression on the hatch cover seal and avoid damage to the coaming/hatch cover interface. Steel/steel bearing pads (Fixpad or Steelpad) are sufficient for most ships. For larger covers, increased relative movements or excessive loadings, a special arrangement based on low friction flexible replaceable sliding pads (Unipad or Lubripad) or non-sliding flexible replaceable pads (Flexipads) is recommended.

Fixpad – Welded steel pad with the mating surface of wear-resistant steel.



Flexipad – A non-sliding flexible bearing pad developed by MacGREGOR. It is made up of flat layers of steel and rubber, bonded together and mounted on a steel plate. The load on Flexipad from the weight of the hatch cover and cargo causes some compression in its rubber elements. A horizontal load causes a sideways deflection of the rubber layers. In general there is no sliding of the pads on the coaming to cause bearing surface wear.

Lubripad – Lubripad was developed by MacGREGOR to meet the needs of larger cargo ships and heavier overall loads. A key feature is the patented balance rubber that acts as an equaliser for uneven loads. The replaceable bronze bearing pad is coated with low friction PTFE for even smoother sliding.

Steelpad – MacGREGOR’s steel pads in a steel holder, mating surface of wear-resistant steel.

Unipad – MacGREGOR’s replaceable low-friction bearing pad. Unipad has a layer of woven PTFE that creates a low-friction surface between the pad and its mating plate. This makes the movement of a heavily-loaded hatchcover possible and minimises pad/mating plate wear-down.

Beaufort scale – A numerical scale rating winds according to ascending velocity, devised in 1805 by Commodore Francis Beaufort. It became the official way of recording wind velocity in 1874, when the International Meteorological Committee adopted it.

Force	Speed (mph)	Description/Ocean Surface
0	0 ÷ 1	Calm; glassy (like mirror)
1	1 ÷ 3	Light wind; rippled surface
2	4 ÷ 7	Light breeze; small wavelets
3	8 ÷ 12	Gentle breeze; large wavelets, scattered whitecaps
4	13 ÷ 18	Moderate breeze; small waves, frequent whitecaps
5	19 ÷ 24	Fresh breeze; moderate waves, numerous whitecaps
6	25 ÷ 31	Strong breeze; large waves, white foam crests
7	32 ÷ 38	Moderate gale; streaky white foam
8	39 ÷ 46	Fresh gale; moderately high waves
9	47 ÷ 54	Strong gale; high waves
10	55 ÷ 63	Whole gale; very high waves, curling crests
11	64 ÷ 73	Violent storm; extremely high waves, froth and foam, poor visibility
12	73+	Hurricane; huge waves, thundering white spray, visibility nil

Bedplate – A structure which forms the base of an engine upon which the bearings and frame are mounted.

“The bedplate consists of high, welded longitudinal girders and cross girders with cast steel bearing supports.”



Photo courtesy of Wärtsilä Corporation

Bedplate of the 7RT-flex60C engine with main bearing caps in place

Before breaking bulk

Before breaking bulk – An expression which actually means “before starting discharging of cargo”.

Bell – A bell used aboard ship as a means of announcing time at regular intervals, as a signal when the ship is anchored in a fog, or as an alarm in emergencies.

Bell crank – A hydraulically-operated mechanism which folds the second pair of covers in a four-panel folding hatch cover. The bell crank consists a pair of hydraulically-operated arms which engage in a lug or roller on the first panel of the trailing pair. The bell crank then turns the panels to their stowage position.





Bellows – A thin metal cylinder with corrugated walls to permit reasonable deflection under applied pressure.

Bellows unit, bellows expansion joint – Bellows-type expansion piece which is fitted into a pipeline to allow expansion and contraction resulting from temperature changes.

Belt unloading system – The discharge system used on self-unloading bulk carriers.

See also **Self-unloading system of the HAI WANG XING**.

Belt-type self-discharging bulk carrier – Bulk carrier equipped with a belt unloading system.

Bend test – A test to measure the ductility of a metal sample by folding it over a specified radius. No cracking or other defects should be found.

Bending load – An external load that produces bending stresses within a body.

Bending moment – The result of vertical forces acting on a ship as a result of local differences between weight and buoyancy. The total of these forces should be zero, otherwise change of draft will occur. At sea, the bending moment will change as a result of wave impact which than periodically changes the buoyancy distribution.

Note: *The maximum allowed bending moment of a vessel is restricted by the class society to certain limits, which are different under port and sea conditions.*

Berth –

1. A place assigned to a vessel when anchored or lying alongside a pier, etc.
2. A bunk or bed.

Berth (to) – To bring a ship into a berth or arrive at a berth.

Berthing – Approaching and securing a vessel in a **harbour**, along a quayside (**berth**).

Bevel – The angle between the flanges of a frame or other member.

Big end – The larger end of a **connecting rod**, i.e. where it joins the **crank pin** of the **crankshaft**.

Bight – A loop formed by doubling back a rope upon itself.

Bilge –

1. The intersection of bottom and side.
2. The lower parts of holds and machinery spaces where bilge water may accumulate.

Bilge alarm

Bilge alarm, 15 ppm bilge alarm – Regulation 16(5) of Annex I of **MARPOL 73/78** stipulates that the oil content of the effluent from **oily water separator** should not exceed 15 parts of oil per million parts of water. The alarm arrangement referred to as “15 ppm bilge alarm” shall activate when this level cannot be maintained, and initiate automatic stop of overboard discharge.

Bilge blocks – Supporting blocks used under the **bilge** for support during the vessel construction or dry-docking.

Bilge keels – Fixed longitudinal plates fitted at the turn of the bilge so that their drag dampens **roll** amplitudes.

Bilge keels are to be attached to the shell by a doubler. In general, both the bilge keel and the doubler are to be continuous. The connections of the bilge keel to the doubler and doubler to the shell are to be double continuous fillet welds.

Butt welds in the bilge keel and doubler are to be full penetration and are to be kept clear of master erection butts. In general, shell butts are to be flush in way of the doubler, and doubler butts are to be flush in way of the bilge keel. **Scallops** and cutouts are not to be used. The ends of the bilge keel are to be suitably tapered and are to terminate on an internal stiffening member.

Bilge main, main bilge line – Part of the bilge system between the bilge pump and the bilge suction chest.

Cofferdams, duct keels and tunnels, if fitted, should be provided with bilge suctions led to the main bilge line.

Bilge piping – The piping used for drain the **bilge wells**.

Bilge plating – The area of curved plating between the bottom shell and side shell.

Bilge pumps – Pumps used for draining the ship various compartments.

In passenger ships, the bilge pumps are to be located in separate watertight compartments.

Bilge radius – The radius of the plating joining the side shell to the bottom shell. It is measured at midships.

Bilge strake – The strake at the turn of bilge extending outward to a point where the side rises vertically.

Bilge suctions – Drain pipes placed on each side at the after end of the holds or compartments. The suction end is fitted with a **strainer** or **mud box**. Bilge suctions in holds are to be connected to the bilge main by branch lines.

Bilge system – A piping system intended for disposing of water that may accumulate in spaces within the vessel (holds, machinery spaces, cofferdams) due to condensation, leakage, washing, fire fighting, etc. It is to be capable of controlling flooding in the **Engine Room** as a result of limited damage to piping systems. However, the bilge system is not able to cope with flooding resulting from a large hull damage not protected in due time.

Bilge system trials – All elements of the **bilge system** are to be tested to demonstrate satisfactory pumping operation, including emergency suctions and all controls. Upon completion of the trials, the bilge **strainers** are to be opened, cleaned and closed up in good order. According to ABS.

Bilge water – The water that collects in the bilges of a vessel which generally becomes foul and noxious. Bilge water also contains fluids from machinery spaces, internal drainage systems, sludge tanks and various other sources. This mixture is collected in the bilge water holding tank, which generally is maintained at an elevated temperature. Regardless

of its source bilge water must be treated to reduce the oil content to levels meeting international regulations for release into the environment.

Note: *Cleaning agents, emulsifiers, solvents or surfactants used for cleaning purposes may cause the bilge water to emulsify. Proper measures should be taken to minimize the presence of these substances in the bilges of a ship.*

Bilge water legislation – Current MARPOL legislation stipulates that separated bilge water containing 15 ppm or below in water can be disposed into international waters. Some national, regional and local authorities have more stringent regulations. In the United States and in the Baltic and North Seas disposal of separated bilge water is only permitted at least 12 nautical miles from shore. In the future, legislation is expected to become even more stringent, requiring levels of oil in water to be reduced further to five ppm for discharge at sea and to zero-discharge in sensitive waters.

Bilge water separator – see **Oily water separator**.

Bilge well – A sump to which bilge water drains. It is important to arrange bilge wells in the way enabling permanent access and possibility of cleaning even when holds are loaded.



Always accessible bilge well designed by BNC

Bill of Lading (B/L) – Document issued on behalf of the carrier describing the kind and quantity of goods being shipped, the shipper, the consignee, the ports of loading and discharge and the carrying vessel. It serves as a document of title, a contract of carriage, and a receipt for the goods shipped on board.

Bill of Sale (marine insurance) – Receipt for payment of the ship purchase price, delivered by the seller to the buyer on completion of the contract.

Bimetallic joints – Bimetallic joints between steel and aluminium are increasingly made with transition bars. These are explosively bonded laminates of steel and aluminium with pure aluminium at the interface, the production of which is itself a welding process. Normal shipbuilding aluminium alloys can be welded to the aluminium side and steels to the steel side. Similar technique can be used with stainless steel for specialised application.

Binder – A resin or other cement-like material used to hold particles together and provide mechanical strength or to ensure uniform consistency, solidification, or adhesion to a surface coating; typical binders are resin, glue, gum, and casein.

Biocide

Biocide – A general term for substances that counter foul actively. Biocides can have very different levels of toxicity and their environmental impact can vary from nothing to significant.

Biofuels – Essentially biofuels, both bioethanol and biodiesel, are derivative of vegetable oils and animal fats. In Europe, rapeseed oil methyl ester (RME) is the common feedstock. In the United States the most common biofuel is E10, a mixture of gasoline (90%) and ethanol (10%).

Bitter end – The inboard end of a ship anchoring cable which is secured in the chain locker by the clench pin.

Bits – Vertical tubular steel posts; two of them are fastened to the rectangular base of a **bollard**.

The bits should penetrate the baseplate rather than just be welded to the top of the baseplate, and strengthening rib plates should be fitted in the base.

Bitumastic – elastic cement used in place of paint to protect steel.

Bitumen – A mixture of extremely heavy hydrocarbons obtained from residue refining process; used for road surfacing, roofing, etc.

Bitumen products – Coaltar, creosote (coaltar and wood), coaltar pitch, anthracene oil, coaltar naphtha. See also **High heat tanker BITFLOWER**, and **Transport of bitumen products**.

Black cargo – Cargo banned by general cargo workers for some reason. For example because the cargo is dangerous or hazardous to health.

Black gang – A slang expression referring to the personnel in the engine department aboard ship, that has an origin back to coal powered ships.

Black petroleum oils – Crude oil, furnace oil, fuel oil, also tar and asphalt.

Blackout – A complete loss of power resulting from damage or equipment failure in a power station, power lines or other parts of the power system.

Blast – A sound signal made with the whistle of the vessel.

Prolonged blast – A blast lasting four up to six seconds.

Short blast – A blast lasting about one second.

Blast-cleaning, shot-blasting – The cleaning of a metal surface by a stream of abrasive particles (blasting agents). See also **Abrasive blasting**.

Blast-cleaning standards – see **Surface preparation grades**.

Blasting agents – Copper works slag (MCU), fused corundum (MKE) as well as iron or steel blasting agents can be considered. The use of silica sand (MQS) shall be avoided.

BLASTOMATIC system – The method of **electrolytic descaling** developed by Wilson Taylor. The method consists of current distribution points (CDP), which are hung inside the area to be cleaned. The CDPs, manufactured from conductive materials and placed in PVC sleeves, are connected via a distributor to a DC supply in the system container. Then, it is connected to an external AC supply. Once Blastomatic has been installed, the tank to be descaled is flooded with seawater and the equipment is left to run for up to 96 hours. A chemical reaction takes place which causes the scale and rust to drop off wherever steel, scale and rust meet. According to Wilson Taylor the system is at least 30% quicker than the conventional methods.

Bleeder – A small cock, valve, or plug to drain off small quantities of fluids from a container or a system.

Blended fuel oil – Heavy fuel and distillate fuels mixed in various proportions, usually 70:30.

Blind sectors – Areas that cannot be scanned by the radar of the vessel because they are shielded by elements of its superstructure, masts, etc.

Blister – A raised area, often dome shaped, resulting from loss of adhesion between a coating or deposit and the substrate.

Blistering – The formation of blisters in a paint film by localised loss of adhesion and lifting of the film. Blisters may contain liquid, vapour or gas.

Block loading – **Bulk carrier** loading arrangement with two consecutive holds loaded and a subsequent one empty.

Blow-down of boiler – Opening blow-down cocks at the bottom of the boiler to reduce the amount of dissolved solids in the boiler water.

Blower – A machine that delivers air at the discharge pressure up to 40 pig. Blowers are used to supply relatively large quantities of low-pressure air to various destinations throughout the vessel.

Boarding arrangements, boarding facilities – All gear, such as **pilot ladders, accommodation ladders, mechanical hoists, gangways, ramps, shell doors, etc.**, necessary for a safe transfer of the **pilot** and personnel to the ship.

It is strange that quite primitive and dangerous rope ladder is still the basic equipment used for embarking and disembarking of pilots. Whenever the distance from the surface of the water to the point of access to the ship is more than 9 m, the accommodation ladder together with the rope pilot ladder shall be provided. According to SOLAS requirements such accommodation ladder shall be sited leading aft. When in use, the lower end shall rest firmly against the ship side within the parallel body length.

Also Regulations on Navigation in Panama Canal Waters (Annex, Section Three, Boarding Facilities, Article 57, point 3) require: "Accommodation ladders shall lead aft, that is, with the lower platform at the after end. The lower end of the accommodation ladder must be within the parallel mid-body of the vessel, not near the bow or stern." "Accommodation ladders which lead forward, or which do not rest firmly against the vessel's side, are not considered safe for use by Authority employees." "An accommodation ladder that is not appropriate may require the use of tugs to make the vessel come to a complete stop while embarking or disembarking personnel. This is considered a deficiency, and tugs shall be provided at the expense of the vessel."

Such requirements are well founded for accommodation ladders used for boarding the ship at sea. Contrary, there are not any reasons to require the same for accommodation ladder used only for boarding when ship is moored at berth. Equipment is the same, (unfortunately also the names) but conditions of work in the port and on the sea are different.

To avoid problems with the Panama Canal two accommodation ladders shall be arranged: one according to the Panama Canal requirements and other for use in port.

Boarding speed – The speed of a vessel adjusted to that of a **pilot boat** at which the pilot can safely embark.

Boat chock – A cradle or support for a **lifeboat**.

Boat fall, boat tackle fall, davit fall – The ropes by which ship boats are lowered or hoisted.

Boat winch – An electric winch for handling a lifeboat.

Boatswain, bosun – The highest unlicensed rating in the deck department who is in direct charge of all deck hands and who in turn comes under direct orders of the master or chief mate or mate.

Body plan

Body plan – A drawing that shows frame lines in elevation. Frame lines forward of the **midship section** are shown on the right of the center line, while those aft of the midship section on the left of the centre line.

Body sections, frame lines – The ship sections obtained by planes perpendicular to the **centreline**. They are drawn on a **body plan** and form part of the **lines plan**.



Boiler – An apparatus used to produce steam, either for the main propulsion or for auxiliary machinery. A boiler is, in general, any closed liquid-containing vessel to which heat is applied. It is also called steam generator as it transforms water into **steam**. Boilers generally consist of metal shells (or bodies), headers and tubes that form the container of the steam and water under pressure and, in certain types, of the furnace and passages for the hot gases. Some boilers have additional drums called superheaters.

Boilers fall into two categories: water-tube and fire-tube ones, according to which substance passes through the tube and which flows round the outside. They are used to provide steam for propulsion or for various ship services.

See also **Oil-fired boiler MISSION™ OS boiler from Aalborg Industries**.

Composite boiler – A firetube boiler which can generate steam by oil firing or the use of diesel engine exhaust gas.

Exhaust gas boiler, economiser – An exhaust gas heat exchanger is a row of tube banks circled by feed water over which the exhaust gases from main diesel engine flow. A boiler drum is required for steam generation and separation to take place. For this purpose, the drum of an auxiliary boiler is usually used.

See also **Exhaust gas boiler MISSION™ XW from Aalborg Industries**.

Boiler mountings – Fittings on a boiler to ensure its safe operation: safety valves, main steam stop valve, feed check valve, water level gauge, pressure gauge connection, air release cock, sampling connection, blow down valve, scum valve, etc.

Boiler scale – Hard deposit on the interior of a boiler plate or tube. The scale generally contains magnesium and calcium carbonates as well as calcium sulphate derived from the water used.

Boiler water treatment – To reduce corrosion and scale formation in boilers, boiler water must be maintained in slightly alkaline conditions by carefully controlled addition of chemicals.

Boiling point, boiling temperature – A temperature at which a liquid boils at a specific pressure. It is usually given at the atmospheric pressure.

Boil-off gas (BOG) – **LNG tankers** are designed to carry natural gas in liquid form at a temperature of – 163°C, close to the vaporization temperature. Despite tank insulation designed to limit the admission of external heat, even a small amount of it will cause slight evaporation of the cargo. This natural evaporation, known as boil-off is unavoidable and has to be removed from the tanks in order to maintain the cargo tank pressure.

Boil-off gas (BOG) combustion system – BOG combustion systems are used only onboard **LNG carriers**. Excess BOG is sent to the engine room via gas heaters by low capacity compressor and is burned by the main boilers as fuel. The main boilers are capable of operating under different fuel combustion modes such as exclusively BOG mode, combined BOG and fuel oil mode, and exclusively fuel oil mode. Although steam turbine systems have been the main form of propulsion used onboard LNG carriers, diesel engines capable of using BOG as fuel have become perfect solution due to their higher operating efficiencies.

Boil-off gas (BOG) recovery system, also BOG reliquefaction plant – An onboard reliquefaction system that recovers boil-off gas in **LNG** carriers and returns it to the **cargo tanks**. The BOG, at about -143°C and atmospheric pressure, is taken from the cargo tanks and passed through a compressor, where its pressure is raised to 4.5 bar and temperature to -60°C. This is then passed through one side of a nitrogen heat exchanger where its temperature is reduced to – 160°C at between 2 and 4 bar. This process converts the gas back into liquid but it must then be passed through a separator to remove any incondensibles. The cargo can then be returned to the tanks via loading or spray lines.

Boil-off rate (BOR) – The amount of liquid that is evaporating from a cargo due to heat leakage and expressed in % of total liquid volume per unit time. Typical values are 0.15%/day and below, recent projected LNG carriers are offered with a BOR close to 0.1%. However as early as 1990, the LNG carrier EKAPUTRA was delivered with a BOR of 0.1%/day.

Bollard – A rectangular base welded to the deck of the ship, upon which two vertical **bitts** are welded. Bollards are used to secure the **mooring lines**.

“The minimum distance between a bollard and fairlead should be 1.8 metres in order to provide adequate space for the application of rope stoppers.”

Bollard pull – The thrust developed at zero ahead speed. Bollard pull is the most commonly used measure of ship-assist tugs performance which have propellers optimized for maximum thrust at close to zero speed. Ships requiring high bollard pull can be fitted with a **nozzle**, which increases thrust by up to 20-40% compared to open propellers.



Free space around bollard is necessary for proper work

Rough estimation of bollard pull $BP = (T \times k_1 \times k_2) / 9.81$, $T = (D \times P_D)^{2/3}$

BP = bollard pull (ton), $k_1 = 0.9$ (10% losses), $k_2 = 1.2-1.4$ (20-40% addition depending on nozzle), T = Thrust (kN), D = propeller diameter (m), P_D = delivered power (kW)

Note: When measuring bollard pull water should be deep enough, there should not be too much current or wind, the vessel should not be close to a pier and the rudder angle should be close to zero degrees.

Bolsters – Flatbeds used to transport damage-free cargoes such as components, pallets, bales, bundles, reels or crates. Heavy-duty forklift trucks and **trailers** move and stow the bolsters.

Bonded goods – Dutiable goods upon which duties have not been paid i.e. goods in transit or warehoused pending customs clearance.

Bonded store – Place on a vessel where goods are placed behind seal until the time that the vessel leaves the port or country again.

Bonding –

1. Adhesive and cohesive strength.
2. Connecting together metal parts to ensure electrical continuity.

Bonjean curves – Curves of areas and moments of sections versus draught, plotted on the sheer plan.

The diagram of Bonjean curves was first proposed at the beginning of the nineteenth century by Bonjean, a French naval engineer, for the purpose of readily obtaining, for any given waterline, the areas of the immersed portion of each transverse section throughout the ship's length.

Boom –

1. A long round spar hinged at its lower end, usually to a mast, and supported by a wire rope or tackle from aloft to the upper end of the boom. Cargo, stores, etc, are lifted by tackle leading from the upper end of boom.
2. A series of floating obstructions secured together to restrict access, or to contain floating matter, e.g. oil.

Boottop, boottopping – The surface of the outside plating between light and load waterlines. It is the hull area which is most exposed to corrosion.

Boss, hub – The central portion of a **propeller** to which the blades are attached and through which the shaft end passes.

Stern frame boss – The curved swelling portion of the ship **hull** around the **propeller** shaft.

Bosun store – A small compartment in which tools and small stuff for repairing cargo gear are kept.

Bottom shell – The shell envelope plating forming the predominantly flat bottom portion of the shell envelope including the keel plate.

Boundary layer – A narrow layer of moving water adjacent to the hull of a ship as it moves through the water.

Bow – The structural arrangement and form of the forward end of the ship.

Bulbous bow – A bulb-shaped underwater bow designed to reduce wave making resistance and any pitching motion of the ship. A bulb is intended to interact with the primary wave making characteristics of the ship so as to develop an independent wave system that reduces the total wave system generated by the hull-bulb combination. However the bulbous bow has a negative effect on power consumption when only partly submerged or not designed properly.

See also **SEA-Arrow bow**, **Sea axe bow**



Long and strong bulbs can be perfect tools to sink rammed ship

Bow chain stopper – A device mounted on tanker **forecastle deck** for securing a **chafe chain**. *Ships likely to trade to Single Point Moorings should be equipped with bow chain stoppers designed to accept 76 mm chafe chain.*

Bow control house – **Shuttle tanker** can be provided with the bow control house, where all navigation and machinery controls are doubled. During all stages of the offshore loading operation a shuttle tanker is controlled from this position.

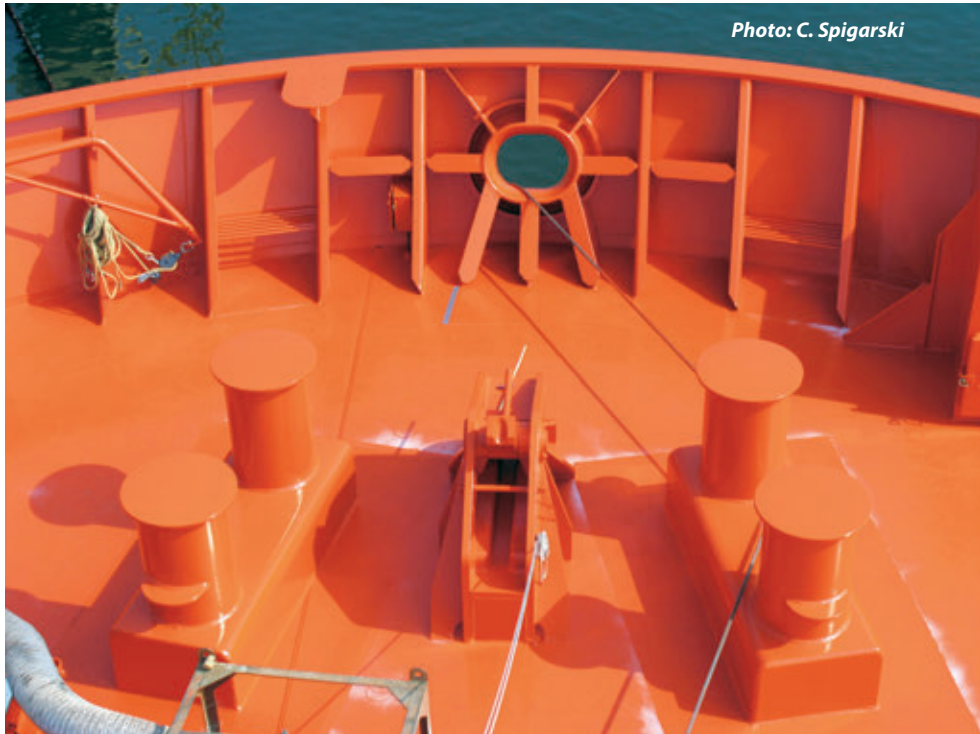

Bow chain stopper

Bow doors – A watertight part of the ship forebody that can be opened to provide clear access to the bow **ramp**. Bow doors are used on ro-ro ferries to enable handling of freight on drive-through basis; vehicles enter over the stern ramp and leave through bow ramp, thus speeding up turn around time. Two types of bow doors are in use: bow visor and the safer clam-type bow door.

Bow visor – A single element connected to the hull by hinge arms and operated by means of hydraulic cylinders. The bow visor forms an integrated part of the bow structure and is equipped with sealing, hinges and cleats. In its open position it is rotated up to 90° to give clearance to the vessel own bow **ramp**.

Clam-type bow door – A side opening twin-section bow door. Each section is attached to the hull by hinge arms which ensure parallel movement when opening or closing. The sections are swung outboard port and starboard by double-acting cylinders.

Side Shifting Bow Door – A patented invention by TTS Ships Equipment. The door consists of two box constructions that open to either side of the door aperture by means of two guide arms mounted above the door opening. During opening of the door, the two sections are manoeuvred horizontally sideways and perpendicular to the ship centreline. Two double-acting hydraulic cylinders are used to operate each section. Weather and sea forces act perpendicularly all round the periphery of the door on the sealing system so that hinges or their bearings are not affected by any forces. A further advantage is that, as there are no manoeuvring devices in the region of the door structure, it can be built stronger and more effectively.

Photo: J. Babicz



Photo courtesy of MacGREGOR



Clam-type bow door

Bow flare – The spreading out of the forebody form from the central vertical plane with increasing rapidity as it rises from the waterline to the rail. Ships with an excessive bow flare are exposed to much higher sea loads than previously expected. **Sea margin** becomes useless because it is not possible to use the installed power in heavy weather due to too high wave impact loads. A good rule of thumb is to avoid bow flare angle against waterline below 50 (45)° in unlimited service (unsheltered waters) and below 45 (40)° in limited service (in sheltered waters), (figures in brackets showing absolute local minimum).

Bow Flare Estimator (BFE) – A guidance tool developed on the basis of **seakeeping** model test results. BFE at a station $x = X/L_{bp} \tan @$, x = distance from **midships**, @ = the smallest angle of flare against waterplane at the station.

Bow flare impacts have been measured for several ferries and passenger cruise ships in head and bow quartering seas significant wave height varying from 1.5m up to 8m. Ferries with a BFE value below 0.50 typically show good performance in full scale. Maximum measured full-scale bow wave impacts in these cases were below 220 kN/m² in typical wave conditions, and below 300 kN/m² in extreme wave conditions.

Bow loading system (BLS) – A system of loading used on **shuttle tankers** to transfer **crude oil** from **FPSO**.

“The bow loading system includes a single 510mm diameter hydraulically operated coupler, a combined mooring and hose winch, a hydraulically operated 500t capacity chain stopper, a hydraulically operated bow roller, rope storage locker, deck house arranged on the forecastle, and hydraulically operated bow door.”

Bow rudder – Ships which are required to go astern for long distances are provided with flap rudder integrated into the **bow**. See also **Rotary bow rudder system**.

The train ferry SKANE is equipped with a bow rudder. The bow rudder has hydraulically activated flaps, which flank the bulbous bow, which, in normal service, are completely flush against the hull. Only when the vessel is required to go astern for long distances at speeds of 13kt or more, will the flaps be activated.

The train ferry MECKLENBURG VORPOMMERN is provided with bow-flap-rudders, integrated into the bulbous bow and each weighing 21t. The rudders are fixed during forward operation by both hydraulics and mechanical means. They allow the vessel to be steered when travelling back to Trelleborg in reverse. This alleviates the need for the vessel to be turned round in port.

Bow slamming – Heavy impact resulting from a vessel forward bottom making sudden contact with the sea surface after having risen on a wave. Similar action results from rapid immersion of the bow in vessels with large **flare**. The magnitude of slamming is drastically decreased as draft is increased. Draft/Length should exceed 0.045 to permit maintaining a reasonable speed and still avoid severe slamming in a seaway.

Bow Steering Module – The Bow Steering Module (BSM) is a pusher assistance boat driven by two **Voith Schneider® Propellers**. Its main function is to generate steering forces at various points on the group of vessels being pushed, preferably at the bow, so that the entire group can be manoeuvred more quickly, more effectively and more safely. With the prototype it has proved possible to shorten round-trip turnaround times by 30%. Its greater manoeuvrability eliminates waiting times, both for itself and other shipping. The Bow Steering Module was named “Ship of the Year 2001” at the Work Boat Show in the USA.

Bow thruster – A lateral thruster fitted in an athwartships tunnel near the bow to improve manoeuvrability. When the bow thruster is used while the vessel is moving forward the thrust is partially counteracted by a vacuum created in the wake of the water jet emanating from the thrusters. The effect is worst when the vessel is moving forward at four to six knots. In such cases the vacuum on the hull can be relieved by the addition of an anti-suction tunnel.

Bow thruster should be located as far forward as possible. Parallel side walls have favorable influence. The suitable tunnel length: 2-3D. An attempt should be made to locate the propeller in the midship plane. In short tunnels the propeller is located eccentrically on the port side, in order to improve the thruster performance to starboard.

The average bow thruster power in ferries is 0.54kW/m² (total bow thruster power/projected windage area), varying up to 0.96 kW/m². The tendency seems to be towards 0.6-0.8 kW/m². Stern thrusters seem to be dimensioned at 0.2-0.25 kW/m².

Box girder – A hollow girder or **beam** with a square or rectangular cross section.



Photo: J. Babicz

Boxcooler – Boxcooler is tube-type **heat exchanger** invented and built in the Netherlands. The first boxcoolers were used for river vessels. Having a good experience with this, applications grew slowly for bigger ships like coasters and fishing vessels. Gradually more type of ships (dredgers, tugs) were supplied with boxcoolers. The principle of a boxcooler is quite simple; cooled water is circulated by force through a U-tube bundle, placed in a sea chest with inlet and outlet grids. Cooling effect is obtained by natural circulation of the seawater in the sea chest or by forced circulation due to the speed of the vessel. The outboard water is warmed up and rises by its lower density, thus causing a natural upward circulation. Boxcoolers can be made of galvanised steel, aluminium brass or HiResist.

Bracket – A plate used to connect rigidly two or more structural elements, such as deck beam to frame, or bulkhead stiffener to the deck, usually of triangular shape.

Backing bracket – A bracket added in order to provide additional support to a member on the opposite side of an existing bracket.

WÄRTSILÄ BOW THRUSTER

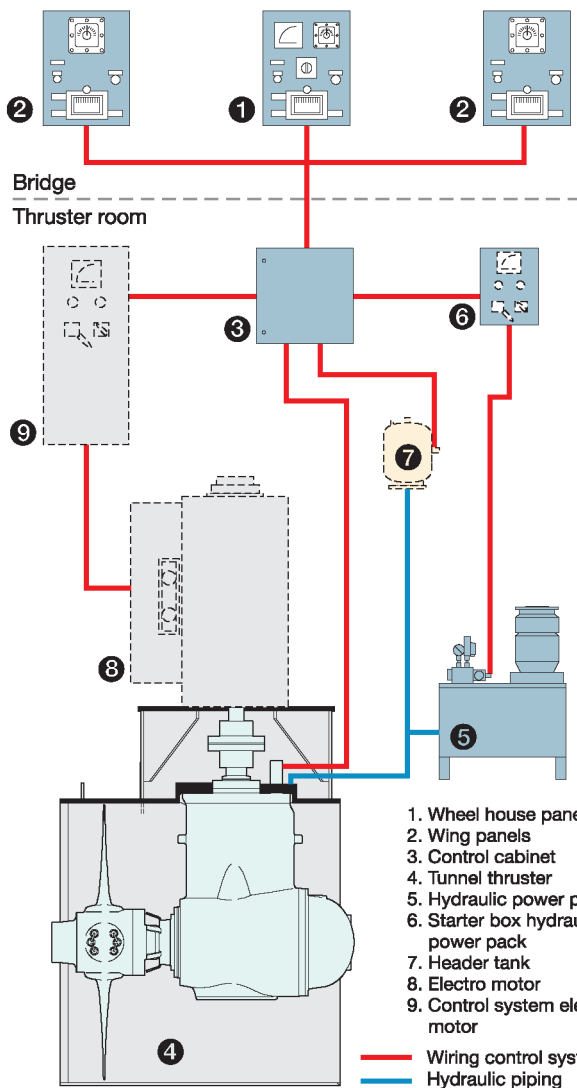
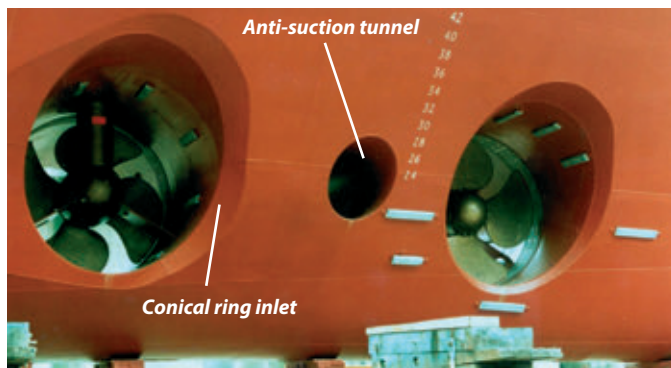

Illustrations courtesy of Wärtsilä Corporation

Beam bracket – A bracket attached at the end of a beam in order to provide continuity of load distribution, stress reduction through the use of an effective web of increasing width thus avoiding the formation of stress concentrations.

Docking bracket – A bracket located in the double bottom to strengthen the bottom structure locally for the purposes of docking.

Tripping bracket – A bracket used to strengthen a structural member under compression, against torsional forces.

Brake power of engine – The observed power measured at the crankshaft or its equivalent, the engine being equipped only with the standard auxiliaries, necessary for its operation on the test bed.

Brake specific fuel consumption (BSFC) – Measure of fuel efficiency within a shaft reciprocating engine. It is the rate of fuel consumption divided by the power produced.

Brass – An alloy of copper and zinc usually with higher percentage of copper.

Breadth of the ship – Depending on the purpose, the following definitions of breadth (B) are used:

1. The maximum breadth of the ship, measured **amidships** to the moulded line of the frame in a ship with a metal shell and to the outer surface of the hull in a ship with a shell of any other material, (MARPOL).
2. The extreme width from outside of the frame to outside of the frame at, or below, the **deepest subdivision load line**, (SOLAS).

Extreme breadth – The maximum breadth over the extreme points between port side and starboard of the ship.

Moulded breadth – The greatest breadth of the ship measured between the inside edges of the shell plating.

Break-bulk cargo – Loose cargo, such as cartons, drums, bags etc., stowed directly in the ship holds contrary to unitised, containerized, ro-ro cargo or **bulk cargo**.



New type of the breakwater applied by Jan Babicz. Such breakwater protects not only cargo but windlasses and mooring winches as well

Breakwater

Breakwater – A vertical **bulwark**-like structure on a **forecastle** deck intended to deflect and disperse head seas shipped over the bow in order to protect deck cargo from damage.



Photos: J. Babicz

Standard breakwater on the 2200TEU container vessel

Breast hook – A triangular plate bracket joining structural members of the port and starboard sides at the **stem**.

Breathing apparatus – Equipment that enables a person to get a supply of oxygen in an environment where little or no air exists, e.g. a smoke-filled compartment.

Two types are in use; the smoke helmet and the self-contained unit using air cylinders. The smoke helmet covers the head and is connected to an air hose. A hand-operated pump supplies the air. The self-contained unit consists of one or two cylinders of compressed air kept in a harness, which is carried on the back. The high-pressure air is fed through a reducing valve and then to a demand valve fitted into a facemask.

Breathing air cylinder – Each cylinder is to contain not less than 1200 litres of fresh air. Every set of self-contained breathing apparatus must be provided with spare cylinders having a total air capacity of 2400 litres.

Bridge -

1. That area from which the **navigation** and ship control is exercised, including the **wheelhouse** and **bridge wings**.



Photo: C. Spigarski

Enclosed bridge

Enclosed bridge – An elevated superstructure having a clear view forward and at each side.

Further reading: ABS Guide for “Bridge Design and Navigational Equipment/Systems” (2002), can be downloaded from www.eagle.org

2. A **superstructure**, which does not extend to either the forward or after perpendicular, (ICLL).

Bridge deck – Deck on which the **wheelhouse** is located.

Bridge-to-bridge communication – Safety communication between ships from the position from which the ships are normally navigated (SOLAS).

Bridge visibility – Risk of collision has always accompanied marine transport. Despite improved navigating equipment, this risk is even greater today due to the growing number of bigger and faster vessels. For this reason, seagoing vessels with the keel laid on, or after 1 July 1998, are to meet strict requirements with regard to the visibility from the navigation bridge.

SOLAS requirements of minimum visibility:

1. The view of the sea surface from the **conning position** is not to be obscured by more than 2L or 500m, whichever is less, forward of the bow to 10° on either side for all conditions of draft, trim and deck cargo under which the particular vessel is expected to operate.
2. From the main steering position, the horizontal field of vision is to extend over an arc from right ahead to at least 60° on each side of the vessel.
3. The horizontal field of vision from the conning position is to extend over an arc of not less than 225°, that is, from right ahead to not less than 22.5° abaft the beam on either side of the vessel.
4. From each bridge wing, the horizontal field of vision is to extend over an arc of at least 225°, that is, from at least 45° on the opposite bow to right ahead and from right ahead to right astern through 180° on the same side of the vessel. The vessel's side is to be visible from the bridge wing.

Panama Canal requirements of minimum visibility:

The surface of the water must be visible one ship length forward from conning positions Nos 1, 2, and 3, when the vessel is laden. If the vessel is in ballast condition, the surface of the water must be visible 1.5L forward.

Despite of these requirements, checking the ship visibility is often limited to define just two visibility lines: one according to SOLAS and another one as required by Panama Canal (for one L). Both lines for the ship without trim and on full draught only. Any change of draught and/or trim will destroy such theoretical visibility. For this reason the master shall be provided with a detailed analysis of visibility taking into account various arrangements of deck cargo, various values of trim and draught.

All new vessels shall be provided with a **Loading and Stability Manual** containing a reasonable number of the Visibility Tables showing blind sectors as function of draught and trim. Another option is to provide ships with a separate Visibility Plan used as an appendix. The Visibility Plan shall be prepared as a part of As Build Drawings. It should contain the classification drawing Navigational Bridge Visibility and the Visibility Tables.

BRIDGE VISIBILITY

Designed by BAOBAB NAVAL CONSULTANCY www.betterships.com

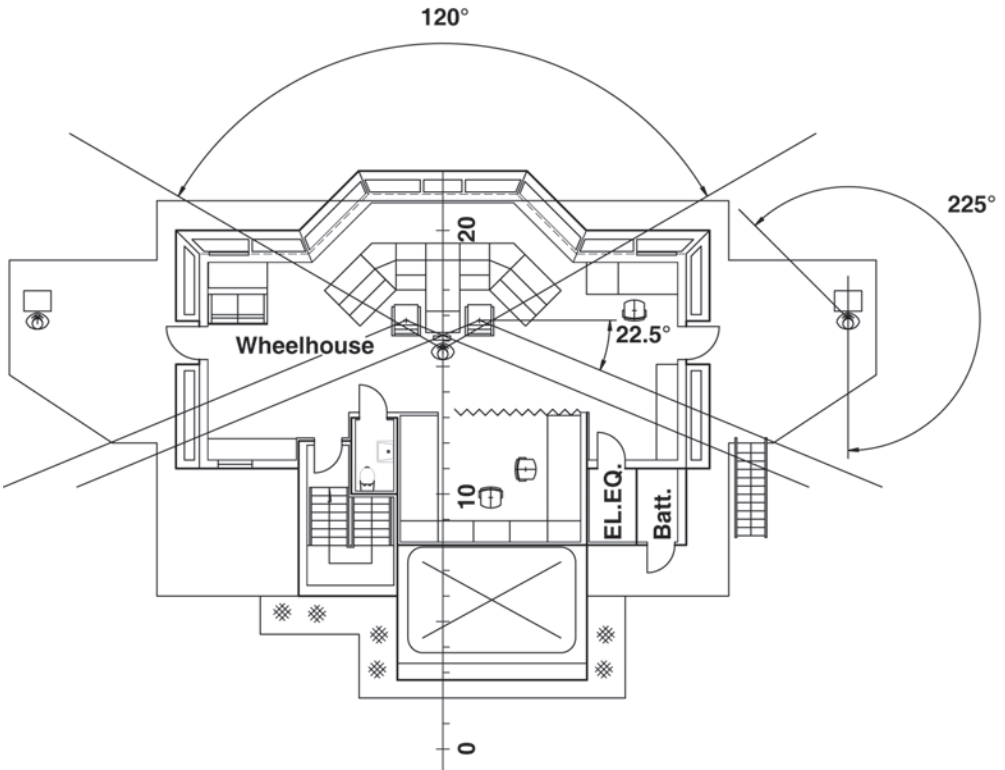
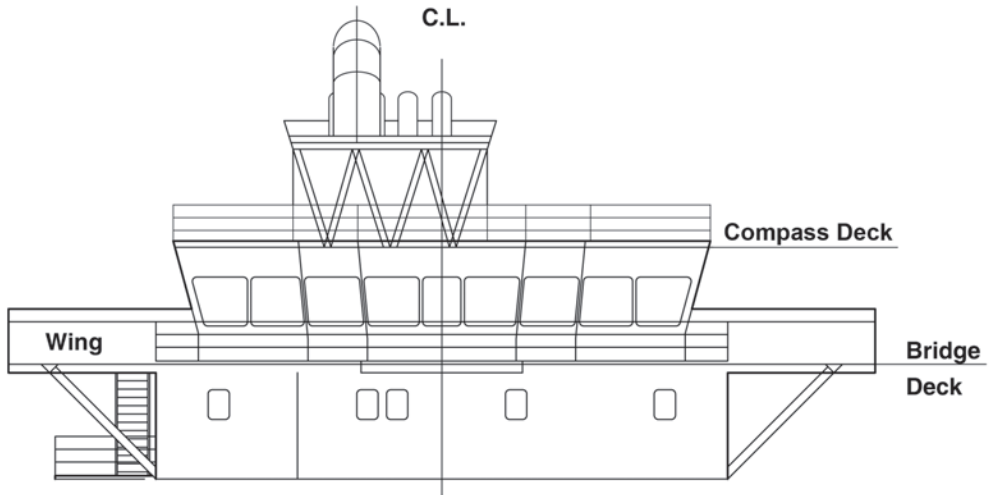



Photo: J. Babicz

Wrong wheelhouse arrangement with high equipment located in field of vision



Picture courtesy of Hermann Buss GmbH



Photo: C. Spigarski

Bridge wing workstation – Workstation from which the ship can be steered and operated during unmooring and mooring, lock passage, taking or dropping the pilot, etc.

Bridge wings – Those parts of the bridge on both sides of the ship **wheelhouse** that, in general, extend to the ship side. According to Regulations on Navigation in Panama Canal Waters bridge wings shall extend to the maximum beam of the vessel, and shall provide a clear, unobstructed passage along their forward portions from the **wheelhouse** doors to the extreme ends of the bridge wings.

Briefing – Concise explanatory information to crew and passengers.

Brine –

1. A term given to **secondary coolants** which are water solutions of calcium chloride, sodium chloride and magnesium chloride.
2. Water with a greater concentration of salt than normal seawater.

Brittle fracture – A brittle fracture is when a crack suddenly propagates extremely rapidly, even at low stress level and can result in the structure breaking in two. See also **Fracture**.

Broaching-to phenomenon – Large following waves acting on the ship can force her to move with the same speed – the ship begins to move with the wave simultaneously. This

Broken stowage

is known as surf-riding. The majority of ships are directionally unstable during surf-riding so the ship can experience an unsteered turn to a beam position relative to the waves. Such uncontrolled turning is known as broaching-to phenomenon.

Broken stowage – Broken stowage is lost cargo space in the holds of a vessel due to the contour of the hull and/or the shape of the cargo. Dunnage, ladders, and stanchions are examples of broken stowage. Broken stowage is shown as a percentage figure which is an estimation of the space that will be lost.

Broker – Person who acts as an agent or intermediary in contract negotiations.

Brokerage (marine insurance) – Commission that the broker is permitted to deduct from the gross premium before passing it to the insurer.

Bronze – An alloy of copper and tin of superior corrosion and wear resistance properties to brass.

BSI Container Specification – British Standards Institution Specification for freight containers.

Bubbling – A film defect, temporary or permanent, in which bubbles of air or solvent vapour, or both, are present. See also **Cavitation**.

Bubble point – The temperature and pressure where a liquid starts to vaporize.

Bucket wheel discharge system – The hopper unloading system on self-discharging dredgers.

The self-discharging dredger SANDFALCON is provided with the hopper-mounted bucket wheel unloader. Driven by hydraulic motors, the wheel is carried on a shaft at the end of a hinged boom. The boom also carries a chute into which the buckets discharge, and a conveyor which feeds onto a cross conveyor. The hopper unit, including carriage and associated drives, is driven by a chain and sprocket arrangement, and the carriage is mounted on six unpowered wheels which ride on tracks fitted to the uppermost edge of the hopper coaming. The bucket wheel is controlled from an operator cabin on the carrier, cutting through the cargo to a depth approximately 1m as it proceeds up and down the hopper. The associated conveyor belt system, which is arranged along the starboard side of the hopper, ends in an elevating conveyor, which is raised at an angle of 25 degrees and is capable of handling aggregates at a peak rate of 1,400 m³/h.

Buckler – A portable cover secured over deck opening of the hawsepipe and the chain pipes to restrict the flow of water through the openings.

Buckling – A deformation of certain parts of ship's structure: a bulge bend or other condition of the structure caused by in plane compressive stresses and/or shear forces. Permanent buckling may occur as a result of overloading, overall reduction in thickness due to corrosion, or damage.

Elastic buckling – The result of compressive loading on a prismatic structure that occurs when critical load is within the elastic range (below the load to cause initial yielding).

Elasto-plastic buckling – The result of compressive loading on a prismatic structure that occurs when the critical load is above the load that produces initial yielding.

Lateral buckling – The result of compressive loading on a prismatic structure that occurs when the critical load is within the elastic range and which involves deformations in the lateral (transverse) direction, usually associated with prismatic sections such as columns.

Snap-through buckling – The near-instantaneous change from one buckled form to another, involving no load increase.

Buckling load – The load necessary to cause buckling instability of a particular structure.

Buckling mode – The deformed shape of a particular structure that is adopted following imposition of an external (compressive) load. It is usually described in terms of the number of waveforms in the longitudinal (and possibly transverse) direction along the length of the structure.

Building sites – A slipway, a **dry dock**, or a ground level assembly area where the ship is completed for launching.

Bulb profile – A stiffener utilising an increase in steel mass on the outer end of the web instead of a separate flange.

Bulk cargo – Cargo which is brought aboard unpacked and has flowing, pumping or pouring properties. The most common bulk cargoes are: petroleum and its derivatives, coal, coke, grain, fertilizers, minerals, ores, bauxite and cement. Dry bulk cargoes are carried by specialised ships, some of which take name after the materials they transport. These include ore carriers, coal carriers and grain carriers.

Solid bulk cargo – Any material, other than liquid or gas, consisting of a combination of particles, granules or any larger pieces of material, generally uniform in composition, and loaded directly into the cargo spaces without any intermediate form of containment.

Bulk carrier, bulker – A vessel designed to carry dry cargo, loaded into the vessel with no containment other than that of the ship's boundaries, as distinguished from the liquid bulk carrier or **tanker**. Conventional bulk carrier is constructed with a single deck, single skin, double bottom, hopper side tanks and topside tanks in cargo spaces.

Common to all are intensive deployment and aggressive environmental conditions and port handling procedures, factors that contributed to a disturbing number of casualties in the 1980s and 1990s. 116 bulk carriers have been lost and 618 seafarers have died since 1992 till 2002. The toll stimulated a number of remedial initiatives by classification societies and IMO, targeting the structural areas of risk.

Structural failure nevertheless remains a consistent and significant cause of losses – 14 bulkers were lost with 23 fatalities in 2000, the average age of the ship 20.4 years – while the presence of heavy cargoes featured in many of the casualties. In 2001 four bulkers were identified as total losses and 64 crewmembers lost their lives; The CHRISTOPHER and HONGHAE SANYO went down with all hands. To prevent this situation, the International Association of Classification Societies (**IACS**) is to introduce the harmonized class notations for bulk carriers:

BC-I, covering design loading conditions for homogeneous light cargo, heavy grain and ballast.

BC-II, vessels designed to carry homogeneous heavy cargo.

BC-III, covering loading conditions for heavy cargo with specified holds empty.

The conventional bulk carrier design, with its single side plating between the upper wing tanks and two lower hopper tanks, exposes its vertical framing to the rigors of **fatigue**, **corrosion** and mechanical damages. Even a significant increase in the scantling of these members would not offer as much improvement as would be derived from a double-sided alternative design.

Double side skin design eliminates the exposed, damage-prone transverse framing and its end attachments. They protect against cargo-related corrosion and mechanical damage. They allow for better quality surface preparation and coating application. Most importantly, they create much stiffer side structures, effectively eliminating the flexing or fatiguing of the side frame and shell plating connection as occurs in conventional designs. Operators of double side skin bulkers also report noticeable operational improvements,

Copyright China Navigation Company



Handymax bulk carrier WUCHANG of B.Delta 37 type designed by Deltamarin

The vessel is fitted with a low-speed Wärtsilä 5RT Flex 50-B engine that has a power 6060kW, which gives the vessel a service speed of 14 knots.

particularly higher discharge rates, simpler cleaning, faster turnarounds and fewer repairs. It must also be remembered that double sides, by themselves, will not eliminate the possibility of loss. Attention must also be paid to freeboard requirements, to the reintroduction of raised forecastles, to strength of vents and deck fittings and to the strength and watertight integrity of hatch covers, together with particular attention to maintenance and coatings.

INTERCARGO, subdivides bulk carriers in **Handysize**, **Handymax**, **Panamax** and **Capesize** according to their deadweight ranges.

Handysize bulk carriers – Bulkers in the 10,000 – 34,999 dwt capacity range capable of carrying either dry bulk cargoes or industrial consignments packed in units (e.g. bags of sugar or flour, metallurgical products, **timber**).

Handymax bulk carriers – Bulkers in the 35,000-49,999 dwt capacity range.

Panamax bulk carriers – 50,000 – 79,999 dwt bulkers, which can pass through the Panama Canal.

Capesize bulk carriers – 80,000 – 199,000 dwt bulkers, the size of which obliges them to go round the Capes of Good Hope and Horn.

Dunkirk-Max – A new “max” design was presented in “Significant Ships of 2001”, named Dunkirk-Max by the builder CSBC; it was marketed as the largest ship, in terms of deadweight and cubic capacity, to meet the specific limitations of the de Gaulle Lock in the port of Dunkirk, France.

See also **Bulk carrier EYLUL K.**

Further reading: *Bulk carriers “Guidelines for Surveys, Assessment and Repair of Hull Structures”, IACS.*

IACS Recommendation 46: BULK CARRIERS Guidance and Information on Bulk Cargo Loading and Discharging to Reduce the Likelihood of Over-stressing the Hull Structure. Both can be downloaded from www.iacs.org.uk

	Handysize	Handymax	Panamax	Capesize
Ship	IVS VISCOUNT	SPAR LYRA	TAI PROGRESS	KOHYOHSAN
Length, oa	179.28 m	190.00 m	225.00 m	289.00 m
Length, bp	172.00 m	183.05 m	217.00 m	279.00 m
Breadth, moulded	28.00 m	32.26 m	32.26 m	45.00 m
Depth, moulded	15.20 m	17.50 m	19.50 m	24.10 m
Draught design	10.20 m	11.10 m	12.20 m	16.50 m
Draught scantling	10.65 m	12.60 m	14.10 m	17.78 m
Deadweight design	32,687 dwt	44,800 dwt	64,000 dwt	157,322 dwt
Deadweight scantling	34,676 dwt	53,000 dwt	77,834 dwt	172,564 dwt
Gross tonnage	22,072	31,000	41,400	87,493
Displacement	43,734 t	65,000 t	88,366 t	193,802 t
Lightweight	9,058 t	11,600 t	10,532 t	21,238 t
Cargo capacity	44,020 m ³	65,700 m ³	92,152 m ³	191,721 m ³

Bulk carrier EYLUL K

According to Significant Ships of 2006

EYLUL K is the double hull 20,000dwt Turkish bulk carrier designed by Delta Marine Co from Istanbul and built by Torgem Shipyard. The vessel has four equally dimensioned (28.20m x 21.00m) cargo holds separated by double-skin transverse bulkheads built on stools, with the spaces between these used as water ballast tanks, and also to contain hold access trunks. This arrangement allows stiffening to be placed inside these tanks, and in the double-hull space, so that the holds are unobstructed for easy cleaning and maintenance. Tanktop structure complies with a Heavy Cargoes notation, with a maximum loading of 18 t/m². Two tiers of steel coils can be loaded and grab discharge is catered for. All holds are mechanically ventilated and can carry dangerous cargoes.

All hatch covers open to the full size of the hold and are totally-enclosed, folding-pair, end-stowing type. Cargo handling is accomplished by three NMF 24t SWL x 28m outreach electric deck cranes positioned between holds. The upper deck has been kept clear of obstructions with all pipes, cables, and valves arranged in access passages above the side ballast tanks or in the double bottom pipe tunnel.

The machinery installation is centered on an 8S35MC main engine developing 5920kW at 137rpm. It is directly coupled to an FP propeller, running in an openwater sternframe fitted with a high-lift rudder. Manoeuvring qualities of the vessel are improved by a bow thruster with CP propeller, developing 600kW at 437rpm. Electrical requirements are fulfilled by three alternators, each of 575kW output.

Engine room bunker tanks are protected from the sea, and the high ballast tank capacity obviates the requirement for ballast to be carried in holds and make ballast exchanges easier.

20,000DWT DOUBLE HULL BULK CARRIER EYLUL K

Drawing courtesy of DELTA MARINE

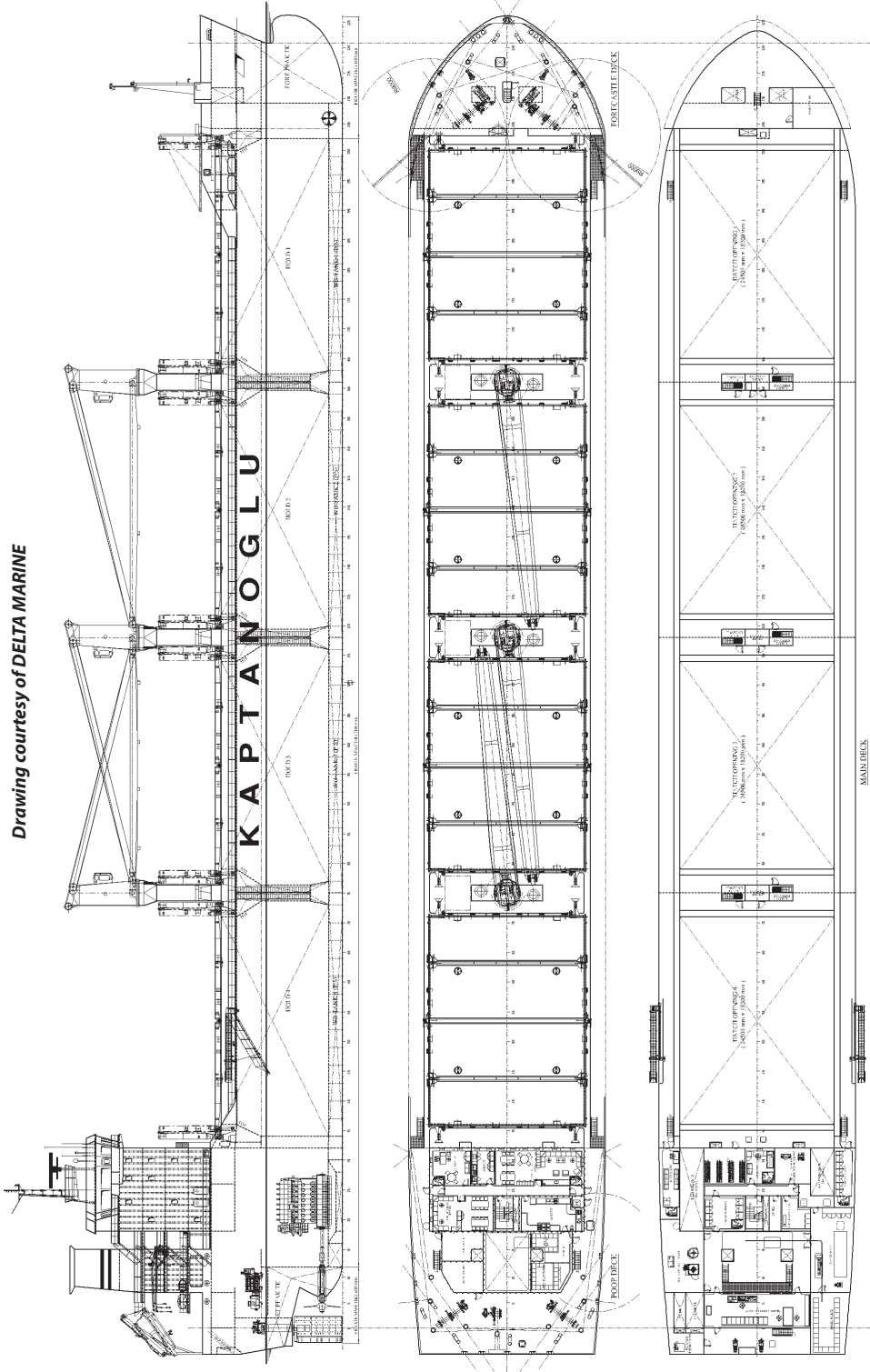

20,000DWT DOUBLE HULL BULK CARRIER EYLUL K

Drawing courtesy of DELTA MARINE

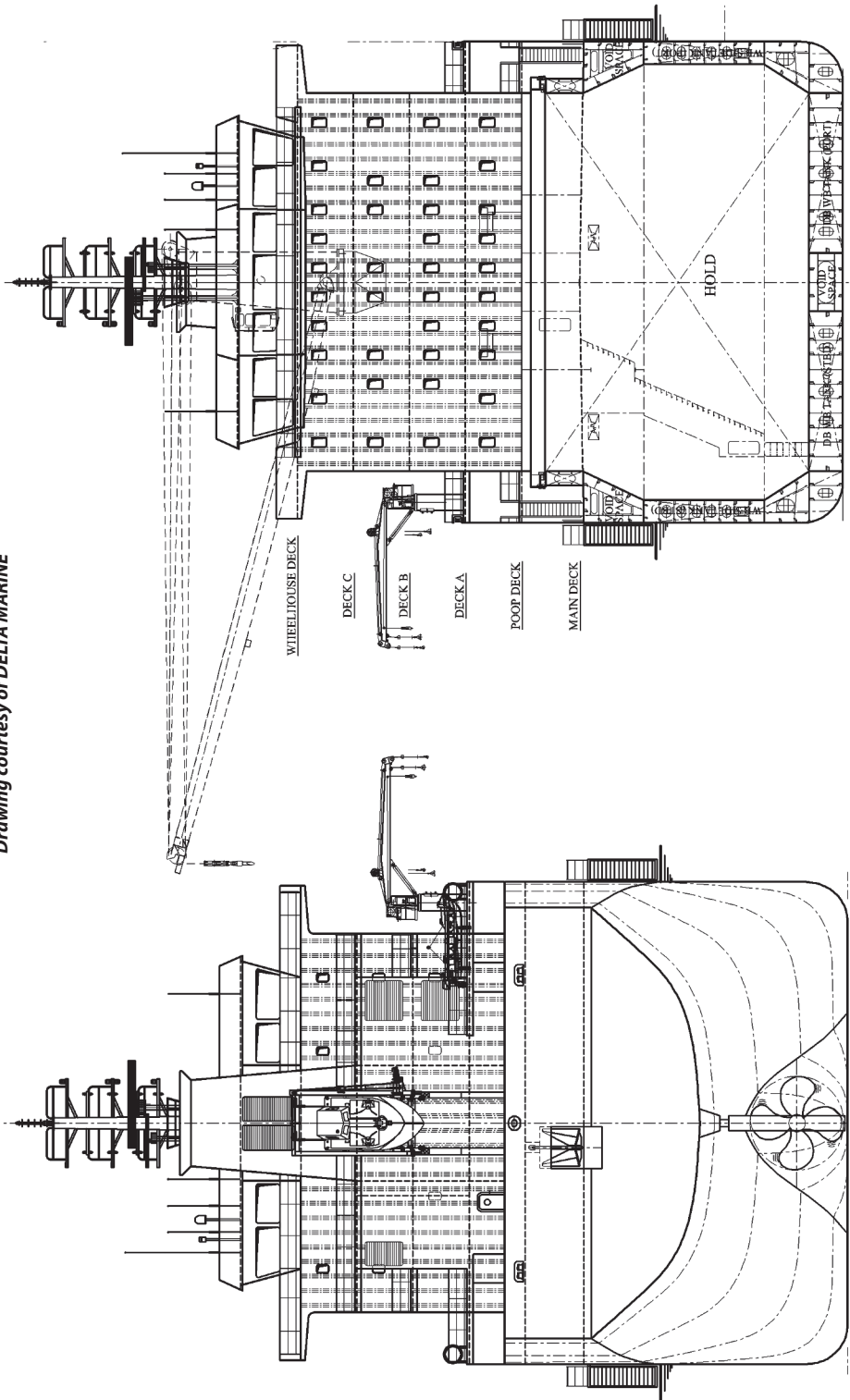

Bulk container

Length, oa: 157.90m, Length, bp: 151.50m, Breadth, mld: 23.20m, Depth to main deck: 12.50m, Draught design/maximum: 8.60/9.00m, Deadweight design/maximum: 20,000/21,000dwt, Gross tonnage: 14,000, Propulsion power: 5920kW, Service speed at 85% MCR: 14.00 knots.

Bulk container – A container designed for carrying free-flowing dry cargoes loaded through hatchways in the roof of the container and discharged through hatchways at one end of the container.

Bulkhead deck – The uppermost deck up to which the transverse watertight bulkheads and shell are carried.

Bulkhead doors – Access doors or **flood** prevention doors. A wide variety of designs and configurations are available: side-hinged door, sliding door, upward rolling door, and top-hinged door. In any case a door can be of a single or multi-panel type. There are three basic ways of operating bulkhead doors; by swinging on hinges, by sliding on guiding wheels and frames or by rolling up into stowage position.

Bulkheads – Vertical partition walls which subdivide the ship interior into watertight compartments. Bulkheads reduce the extent of seawater flooding in case of damage and provide additional stiffness to the hull girder. They can be flat or corrugated.

After peak bulkhead – A bulkhead which forms the forward boundary of the **aft peak**.

Collision bulkhead – The foremost main transverse watertight bulkhead. It extends from the bottom of the hold to the freeboard deck or to the forecastle deck and is designed to keep water away from the forward hold in case of bow collision damage.

Corrugated bulkheads – Bulkheads with **corrugated** plating, eliminating the need for welded stiffeners.

Engine room bulkhead – A transverse bulkhead either directly forward or aft of the engine room.

Portable bulkhead, removable bulkhead – Steel construction used to divide a long hold into separated sections.

“The box-shaped cargo hold can be subdivided into separated hold sections with the aid of two moveable grain bulkheads. These grain separations consist of double walled steel bulkhead sections, which are connected to the tanktop using the container corner fittings. Connections in the hatch coaming consist of a heavy socket corresponding with an opening in the grain bulkhead section. A heavy pin through both parts of the connection secures the bulkhead in position. The pin can be inserted from outside. The bulkhead sections are handled with an electro-hydraulic driven traveling hatch cover crane. When not in use the bulkhead sections can be stowed away in such a way that they do not encroach with the ship's cargo hold space.”

Strength bulkhead – Bulkhead that contributes to the strength of a vessel.

Swash bulkhead – Longitudinal or transverse non tight bulkhead fitted in tank to reduce the surge of the liquid when the ship rolls and pitches, and consequently to reduce the dynamic impact (sloshing forces) of the liquid on the surrounding structure. A plate used for this purpose but not extending to the bottom of the tank is called a swash plate.

Bulwark – Fore-and-aft vertical plating directly above the upper edge of the ship side surrounding the exposed deck(s).

Bunk – A berth, or bed, usually built in.

Bunker (to) – To load fuel into ship's fuel tanks for its own use as distinguished from loading it as cargo.

Bunker –

1. Fuel oil for the main propulsion machinery.
2. A compartment for the storage of fuel oil used by the ship's machinery.

Bunker Delivery Note (BDN) – The standard document required by Annex VI of MARPOL which contains information on fuel oil delivery: name of receiving vessel, port, date, data of a supplier, quantity and characteristics of fuel oil. Every BDN is to be accompanied by a representative sample of the fuel oil delivered.

Fuel oil suppliers are to provide the bunker delivery note. The note is to be retained on the vessel, for inspection purposes, for a period of three years after the fuel has been delivered.

Further reading: *Regulations for Prevention of Air Pollution from Ships – Technical and Operational implications, (can be found on www.dnv.com/maritime).*

Bunker stations – Fuel receiving stations, usually at an upper deck level, port and starboard, furnished with valves, elbows, pressure gauges, filters and relief valves.



Photo: J. Babicz

Bunker station

Bunkering clause – A time charter agreement will stipulate the terms under which the bunkers on board will be delivered to the use of the charterers and the terms under which the bunkers remaining on board will be redelivered to owners.

Bunkering vessel – A small tanker fitted with fuel pumps and a crane for hose handling, used for loading fuel oils into ship tanks.

Buoy – A floating object used as an aid to mariners to mark the navigable limits of channels, their fairways, sunken dangers, isolated rocks etc., or as reference point for navigation or for other purposes. Buoys are indispensable especially on coastal waters or close to port.



Photos: J. Babicz

Buoys

Cardinal buoy – A seamark, i.e. a buoy, indicating the north, east, south or west, i.e. the cardinal points from a fixed point such as a wreck, shallow water, banks, etc.

Buoy gallows – Frames mounted on the cable vessel side to deploy and recover cable buoys.

Buoy handling crane – A special crane used onboard of **aids to navigation service vessels**. A buoy-handling crane has a jib with fork-type end. This important feature enables the crane to lift buoys using two shackles attached either side of the buoy flotation chamber and to avoid damage to the buoy tops, which contain lights and other electronic equipment.

Buoy tender, also buoy-layer, and buoy laying vessel – The ship designed for handling navigation buoys and beacons, usually fitted with a deck crane and a spacious working deck. See also **Aids to navigation service vessel**.

The Fassmer-built 300t buoy-layer NORDEN is characterised by a superstructure set well forward on a raised foredeck ahead of a 70m² working deck able to accept a loading of 20t. On the centreline of an aft structure and machinery casing is the 8t/10.40m main crane with swell compensation and self-propelled head role. Aft of this island structure there is a rescue boat carried under a crane, and to starboard a workboat. Length: 39.20m, beam: 8.90m and draught: 1.60m.

Buoyancy – The hydrostatic force acting vertically upward on the floating vessel, equal to the weight of water displaced by this vessel.

Burner – An **atomizer** used in a **boiler**.

Bus bar – Copper bars fitted at the back of the main switchboard as part of the distribution system. A.C. generators fed to the bus bars and **circuit breakers** are used to draw off the supply.

Butt, butt joint – The end joint between two plates or other members which meet end to end. Typically a butt joint is used to describe the welded connection between two plates in the transverse direction.

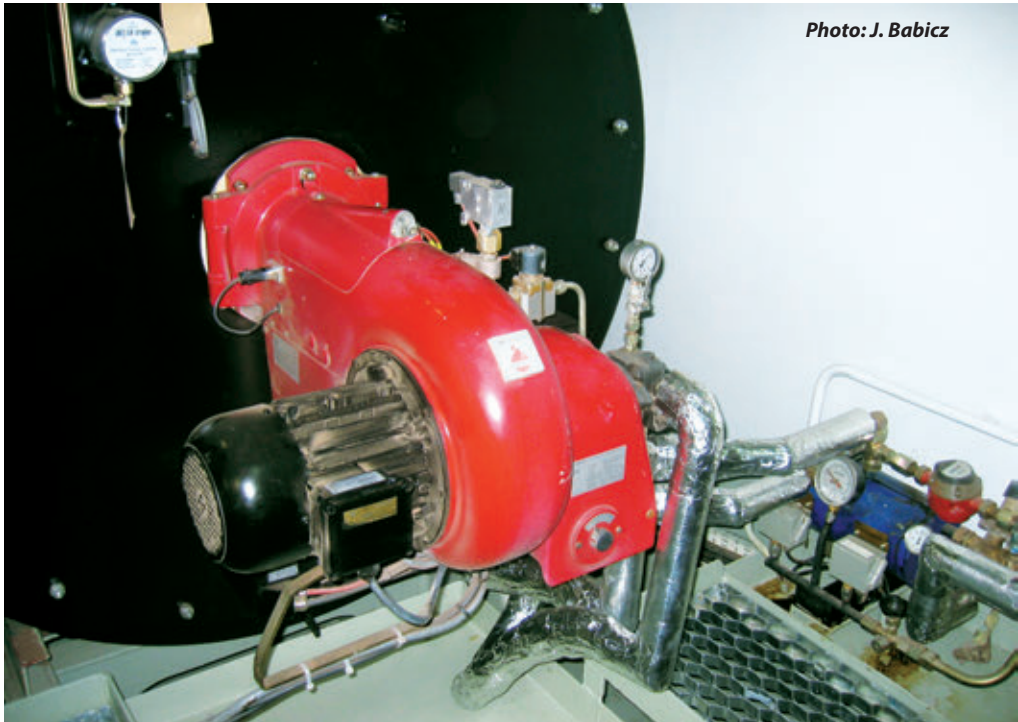

Photo: J. Babicz

Burner

Butt weld – A weld between the edges of two metal plates, which meet but do not overlap.

Butterfly valve – A rotary stem valve with a centrally-hinged disc of the same dimension as the pipeline. The valve opens into the pipeline and therefore takes up little space, permits large flow rates and gives minimum pressure drop.

Buttocks – Lines obtained by cutting the hull surface with longitudinal planes parallel to the ship's centre line.

BWM Convention – see **International Convention for the Control and Management of Ship's Ballast Water and Sediments.**

By-pass – Any arrangement to control and turn away a fluid from its main flow path.

Cabin – A compartment in the accommodation area provided for a passenger or member of the ship complement. With most cabins having their own private toilets, the location of these is important. Sanitary units should be arranged to ensure easy access to pipe connections, and in straight vertical lines to simplify piping.

Onboard the ferry COLOR FANTASY there are 966 cabins (604 with windows; 63%; 141 Suites) for maximum 2750 passengers and additional 250 cabins for the crew (221 crew, 29 officers). Passenger cabins vary in size from 10.5m² (Three-Star inside), 13.5–13.7m² (Three-Star Sea-/Promenade-view), 13.9m² (Four Star Fantasy Class in- and outside) and 24.5m² (Five Star Fantasy Suite) as well as 35m² (Five Star Owner Suite). The 966 passenger cabins are consisting of 494 cabins viewing the sea, 120 looking to the promenade and 353 inside.



Luxury cabin on a passenger cruiser

All cabins should be designed as standard modules, equipped with private sanitary units. Sanitary units (WC/shower) must be arranged in vertical lines, with easy access to pipe connections (small doors should be arranged).

As far as possible, cabins on container ships should be arranged in such a way to have at least one window with clear view, not obstructed by containers.

Captain's and Chief Engineer's cabins are usually located on the highest deck. Such arrangement causes no problems on board vessel having a crew lift, however nowadays, to save money, installing lifts is less common practice. In the case of any alarm, the Chief Engineer must go down to the Engine Room, similarly all representatives of Authorities or class surveyors have to go high up to see the Captain. It would be much more convenient to arrange Captain's Office as well as cabins for Chief Engineer and 1st Engineer at the lowest deck possible.

SINGLE BERTH CABIN



Cabin aboard the oil spill response vessel ARKONA. Photo courtesy of Peene-Werft

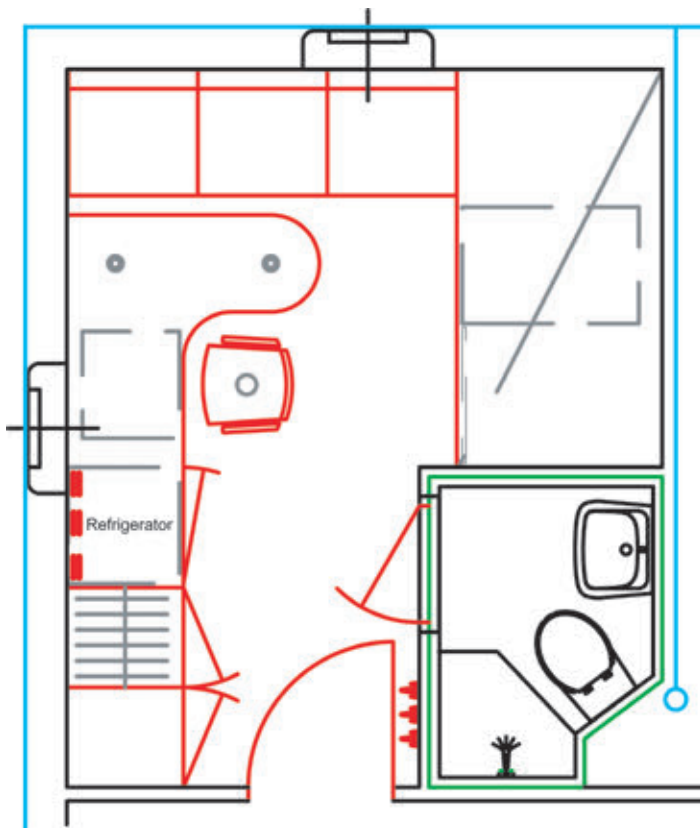

Standard single cabin designed by Baobab Naval Consultancy

Cable –

1. A rope or chain connecting a vessel to the **anchor**.
2. Wire or rope primarily used for mooring a ship.
3. One hundred fathoms or one tenth of a **nautical mile**.

See also **Telecommunications cable**.

Cable bundles – Arrangement of two or more cables laid parallel and touching one another.

Cable diverter – The cable diverter is sited aft of the cable drum engine and ensures the proper cable deflection and retainment during pick-up operations. This will ensure that the cable fleeting is maintained over 180° of the drum-fleeting ring.

Cable handling equipment, cable machinery – Installation and maintenance of a submarine cable is a complex operation requiring sophisticated tools. The primary cable handling equipment of a typical **cable-layer** is designed to load cable from ashore into **cable tanks** and discharge it from the tanks onto the seabed. Central to effective cable handling is the wheel pair – two tires on wheel rims mounted on hydraulically operated arms opposed to each other. These arms enable the driving wheels to grip the cable, joints and transitions as they pass through.

Cable Transporter – A highly versatile, mobile or fixed, self-contained cable handling machine, that uses a pair, or pairs, of motorised wheels to transfer cable or rope between the ship and the storage tanks.

Linear Cable Engines (LCE) are of a modular construction assembled in sections of wheel pair assemblies. They are arranged as bi-directional systems for both cable laying and repair operations, whilst posing minimum risk to the cable or repeaters. Each individual wheel pair is controlled by fully synchronising speed, wheel opening and pressure/squeeze onto the cables. At very low cable tension in shallow waters, the sensitive control systems will automatically reduce the drive unit torque, reducing the risk of cable slip. Typical combinations of up to 18-36 wheel pairs are available, depending on required pulling force, available deck space or requirements of specific cable types.

At the outboard end of the LCE, a heavy-duty hydraulically-operated cable gripper is fitted, sometimes referred to as a stonker. In case of sudden outboard tension or catastrophic failure of the LCE, its jaws can close on the cable stopping the cable from running overboard.

Draw Off- Hold Back Engine (DOHB) – A back tensioning engine usually installed at the aft end of the cable ship, forward of the Cable Drum Engine (CDE). It is used together with the CDE for cable repair work; it can also be used independently for cable transport duties. DOHB are usually four-wheel pairs, one after the other mounted on a traversing frame. The first and the second wheel pairs are separated from the third and fourth wheel pairs; when a joint or repeater is passing through you will have at least one wheel pair at any time gripping the cable either before or after the repeater.

Cable handling operations:

Cable laying – When laying off, the primary need is to control the speed and tension at which the cable departs the ship. This control is done by means of cable machines: a Linear Cable Engine (LCE) or Cable Drum Engine (CDE). Where a LCE is used, cable is pulled up from the cable tank or **carousel** along the trackway and fed into the first wheel pair of the LCE. The LCE is driven from a control room where the operator is following a lay plan driven from survey data. With a CDE, cable is led from the static tank

or carousel along a trackway to the wheel pair of a Draw Off – Hold Back Engine (DOHB) and then around the cable drum, usually for four turns. The cable is led off the drum by a traversing diverter over a roller sheave at the vessel stern or bow. During laying operations, the CDE is pulling the cable from the tank and the DOHB is in holdback mode, thus the cable is driving the wheel pairs allowing a preset tension to be set up between the DOHB and the CDE.

Cable burial – Offshore activities, fishing, earthquakes and landslips can threaten submarine cable integrity. Cable burial is commonly regarded as the most effective protection. Burial depth can be up to 10m under the seabed in areas of soft silt, (normally between 1m and 3m).

Cable repair – The primary activity performed during a repair operation is raising and lowering cable from the ocean floor. This is accomplished by cable machinery hauling on grapnel rope over large-diameter sheaves. The cable hauling machinery is either a large round drum or a series of rubber tires mounted in pairs driven by a hydraulic motor. In order to reduce friction and protect the cable from sharp bending, large roller sheaves are installed at the deck edge.

Cable layer SEGERO

According to the **Maritime Reporter** December 1998 The SEGERO was built in 1998 by Hanjin Heavy Industries Co. for Korea Submarine Telecom. The ship was designed to carry out the laying, burying and repair of intercontinental submarine fiber-optical cable, with particular reference to the severe weather conditions and extremely low temperatures. The design follows the fully stern-working concept which permits to continue work even in the worst weather conditions and by allowing a conventional bow-form to be adopted, providing a high cruising speed.

The ship has two main cable tanks of total capacity 2050m³ (3900 tonnes) and two 80m³ cable tanks. Most cable work is concentrated on the continuous, mainly closed, upper deck, using two 3.6m diameter stern sheaves straddled by a 35-ton safe working load (SWL) **A-frame**. This can work in an arc ranging from 80 degrees over stern to 80 degrees inboard up to the sea state 5, and provides for launching and recovering a **cable plough** from either of the two cable lines. One 20-ton SWL telescopic crane and one 8-ton articulated crane are also fitted aft. The starboard and port cable line consists of a Dowty 4m diameter/40tonne-pull cable drum engine and a 4tonne/four-wheel-pair draw-off/hold-back engine on each side.

The diesel-electric power system is based on four ABB generators, two of 3400 kVA, one of 2300 kVA and one of 850 kVA. Electric power is distributed through two main switchboards, with four transformers, supplying two 2700kW ABB propulsion motors, which drive two azimuth propulsion units. The propellers are fitted with steerable nozzles to help to prevent cable fouling. Additional manoeuvrability is provided via a pair of Wärtsilä-Lips 1200kW tunnel **thrusters** and a 1500kW White Gill vectoring unit operating forward.

The vessel is provided with a Kongsberg Simrad integrated monitoring and control system (IMCS), which consists of **dynamic positioning** system, thruster control system and vessel control system. The dynamic positioning system incorporates special sensors, functions and operational modes which are related to the cable laying and trenching applications. The thruster control system incorporates lever control of each thruster, as well as an independent joystick system with common control of all selected thrusters. The vessel control system

Cable laying and repair vessel ATLANTIC GUARDIAN

incorporates alarm monitoring and control system, including power management functions. The ship is also equipped with the STN Atlas total navigation system, including **radar**, Doppler sonar, echo sounder as well as JRC GMDSS. To provide more comfortable working and living conditions for the ship complement of 63, a longer rolling period has been achieved using sufficiently large and long **bilge keels**, and the **anti-roll tanks**.

Length, oa: 115.4m, Length, bp: 95.6m, Breadth, mld: 20m, Deadweight design/scantling: 3706/6409dwt, Draught design/scantling: 6.3/7.8m Service speed: 16.6 knots at 100% MCR, Water ballast: 1848m³, Fuel consumption: 34.3 ton/day (main engine).

Cable laying and repair vessel ATLANTIC GUARDIAN

According to **MER** April 2002

The 3250dwt stern working cable vessel was built by Van der Giessen-de Noord BV, The Netherlands, in 2001. The ship has a number of features designed to ensure that both sea keeping and station keeping performances are high. The length of the vessel, 102.13m, was selected to suit good characteristics at zero speed (cable repair work) combined with a good performance at transit speed up to sea state six. An Alstom dynamic positioning (DP) system of the ADP 21 duplex type, with automatic backup facility, allows better control of the ship when station keeping. The DP control system is specifically programmed for cable working and gives the operator full control of the vessel, linked to satellite positioning and Differential Global Positioning System (DGPS).

All cable operations are carried out over the stern; a system first applied to CS ASEAN RESTORER built by Kvaerner Masa-Yards in 1994. This has proved very successful in operation, and has been adapted for the new vessel to provide more working space in the stern, and heavy working machines and equipment have been better placed in more sheltered locations. Working areas such as the jointing and testing rooms, and the **wheelhouse** are positioned amidships in order to reduce the effect of roll and pitch on the performance of the crew. To reduce downtime due to water on deck significantly, the ship benefits from a 5.7m (minimum) freeboard to the cable working deck.

The ship is equipped to repair damaged cable (10/70mm diam) in ocean depths down to 5000m; some laying and shallow water ploughing work can also be done. Two 12m-diameter main cable tanks and two 6m diameter spare tanks enable the ship to carry up to 1070m³ of cable.

Cable handling machinery supplied by Dowty is operated by built-in hydraulic power packs. The ship is equipped with two 4m-diameter cable drum engines, each with a 40t brake and 28t-line pull, two four-wheel-pair draw off/hold back engines and diverters. Twin two-wheel pair cable transporters are also installed. The cable machinery includes also two 3m-diameter cable lying/repair sheaves, a plough towing sheave supported by a 10t A-frame, two deck cranes of 5t and 1.5t SWL and two 2.3t SWL gantry cranes.

The vessel is fitted with a **remotely-operated vehicle** (ROV) capable of operating at water depth of 2000m. As safety is of chief importance during hazardous cable maintenance operations, the amidships wheelhouse/operations room offer a clear view of cable working areas and the ROV deck.

The ship is propelled by two Wärtsilä Lips L-type azimuthing propulsion **thrusters** (2x2200kW) operating in high efficiency nozzles. Contributing to the DP system are three bow thrusters (3x900kW). All are supplied from a high voltage diesel-electric propulsion installation using three ABB 2690kW alternators driven by Wärtsilä 9L26A diesel engines.

CABLE VESSEL

Photos courtesy of MERWEDE Shipyard



Cable vessel BOLD ENDEAVOUR



Cable handling machinery of ATLANTIC GUARDIAN

Cable lifter

Length, oa: 102.13, Length, bp: 85.95, Breadth, mld: 18.00, Depth to work deck: 11.80m, Draught design/scantling: 5.75/6.00m, Deadweight design/scantling: 3250/3600dwt, Speed maximum/economic:15/12 knots.

Cable lifter, chain lifter, wildcat – steel casting in the form of a deeply-grooved drum with whelps which engage the links of the anchor chain.

Cable tray – Pre-fabricated steel devices for securing of permanently installed cables onboard a vessel or an offshore rig. The cable trays are welded or bolted.

Cable vessel – A special ship designed to perform **cable operations** such as repair, laying and ploughing, usually combined repair-and-layer ship. See also **Cable layer SEGERO** and **Cable laying and repair vessel ATLANTIC GUARDIAN**.

Vessels for cable maintenance need to be faster, so they can respond quickly to maintenance requests at cable repair sites. They also need to be more manoeuvrable, because repair work usually involves handling two ends of cable, as opposed to one for standard cable laying work.

Cabotage – Coastal trade, i.e. transport of goods by ship between ports along the same coast or between ports within the same country. Many nations, including the United States, have cabotage laws, which require national flag vessels to provide domestic interport service.

Calling port, the port of call – Port where a ship moors (or anchors) and crew are allowed to leave the ship to visit the port. Crew baggage and ship stores will not normally be loaded or off-loaded at calling ports.

Calibration – The process in which the readings of an instrument are compared to some standard or known value.

Calibration gas – A gas with an accurately known concentration that is used as a comparative standard in analytical instrumentation.

Calorific value – The heat energy released during combustion of fuel.

Cam – A shaped projection on a rotating shaft which imparts a motion, usually linear, to a follower.

Camber – The curvature of the deck in a transverse direction. Camber is measured between the deck height at the centre and the deck height at the side.

Camel – A fender used to keep a vessel away from a pier or quay to prevent pier or hull damage; usually a floating body with massive padding of rope, tires, etc.

Camshaft – A shaft fitted with one or more cams and driven by a mechanism from the crankshaft.

Camshaft lubricating oil system – This system lubricates the camshaft bearings, the roller guides and supplies oil to the hydraulic exhaust valve gear. The oil circulates in a closed system, consisting of a tank, one service pump and one stand-by, a cooler and a filter to the camshaft mechanism and then is drained back to the tank through a magnetic filter. The system can be delivered as a unit (Camshaft Lubricating Oil Unit).

Cant – A log which is “slub-cut”, i.e. ripped lengthwise so that the resulting thick pieces have two opposite, parallel flat sides and in some cases a third side, which is sawn flat.

Capacity of vessel – Capacity of vessel can be measured in many ways depending upon the type of vessel. Capacity of traditional general cargo vessel is defined as bale capacity or grain capacity. Number of 20-foot containers, which can be accommodated onboard, defines the capacity of **container ships**. Capacity of **car carriers** is characterised by number of standard cars which can be transported. Volume of cargo tanks defines the capacity of **tankers**.

Bale cubic capacity – The space available for loading cargo extending to the inside of the cargo battens on the frames and to the underside of the beams.

Grain cubic capacity – Maximum space available for cargo extending from the inside of shell plating to the underside of the deck plating.

Capacity Plan – A plan of the spaces available for cargo, fuel, fresh water, water ballast, etc, and containing cubic or weight capacity lists for such spaces and a scale showing deadweight capacities at varying draughts and displacements.

It would be difficult and inconvenient to gather all those information and place them on one plan in a clear and legible manner. In addition, all these pieces of information can be found on various other drawings. To avoid repeating data and multiplying existing documents it is recommended to create a Capacity Plan as a set of documents listed below:

1. General Part
2. Coordinate System
3. Draught Marks
4. Load Line Mark and Deadweight Scale
5. Tank Space Information
6. Cargo Space Information

Capital-intensive tonnage – Vessel demanding relatively large investments, e.g. cruise ships, gas and chemical tankers, etc.

CAP propulsion system – The CAP propulsion system is a new propulsion and manoeuvring system developed by Motala Verkstad. It consists of two independently moving hub units with the outer one fitted with a **propeller**. The propeller can be moved 30 degrees either side off the centreline to enable directional steering. Thus a **rudder** is excluded.

Cap sizing – In common understanding, by capsizing people generally mean a sudden passing of a ship from the upright position to the upside down position. More precisely, capsizing or loss of stability can be defined as exceeding the amplitude of rolling or a heel at which operating or handling a ship is impossible for various reasons.

A ship can capsize because of the variation of the metacentric height GM, or of the righting arms GZ, in head or following seas (**parametric resonance**) or due to the loss of control in severe following or quartering seas (**broaching-to phenomenon**). Nonetheless, a ship can capsize even in port if the metacentric height is negative.

Further reading: "Ship Stability in Practice"

Capstan, warping capstan – A warping head with a vertical axis used for handling mooring or other lines.

Anchor capstan – A capstan in which the warping head is replaced by a **cable lifter**.

Captain, master – The highest officer aboard ship responsible for the safety of the ship, crew and cargo. The captain oversees all ship operations, keeps ship records and handles accounts. He takes command of vessel in heavy weather and in crowded or narrow waters. Handles communications. Receives and implements instructions from home office.

Car carriers – Vessels specially designed for efficient transport of cars (pure car carriers), or variety of cars, trucks, tractors and buses (pure car/truck carriers). Cargo access/transfer equipment of typical car carrier consists of a stern quarter ramp, side ramps, internal ramps with covers and hoistable decks. Vehicles drive directly into the ship and via internal ramp system to various decks.



Stern anchor capstan:

- 1. Warping drum
- 2. Horizontal cable lifter
- 3. Chain
- 4. Chain pipe

Longhaul car exports were originally handled by bulk carriers fitted with portable or hinge-away car platforms and loading/discharge performed by ship derricks or cranes. But massive rise in demand for global vehicle movements dictated the creation of purpose-designed multi-deck pure car carriers (PCCs) exploiting **ro-ro** cargo handling system. This type of vessels was developed in the 1950s by Wallenius Line, the pioneer in the carriage of vehicles by sea. RIGOLETTO and TRAVIATA, both delivered in 1955, were the first ships specially designed to carry cars by adding extra decks. ANIARA was Wallenius Line first car carrying ro-ro. Delivered in 1963 it featured a **bow door** for the first time.

Tonnage with capacity for over 6000 cars on 12 decks emerged, along with pure car/truck carrier (PCTC) designs offering rolling freight flexibility for many vehicle types: not just



Car carrier GLORIOUS LEADER designed and built by Stocznia Gdynia S.A.

**ELBE HIGHWAY
CAR CARRIER 2130 UNITS PROJECT 8245 STOCZNIA GDYNIA S. A.**

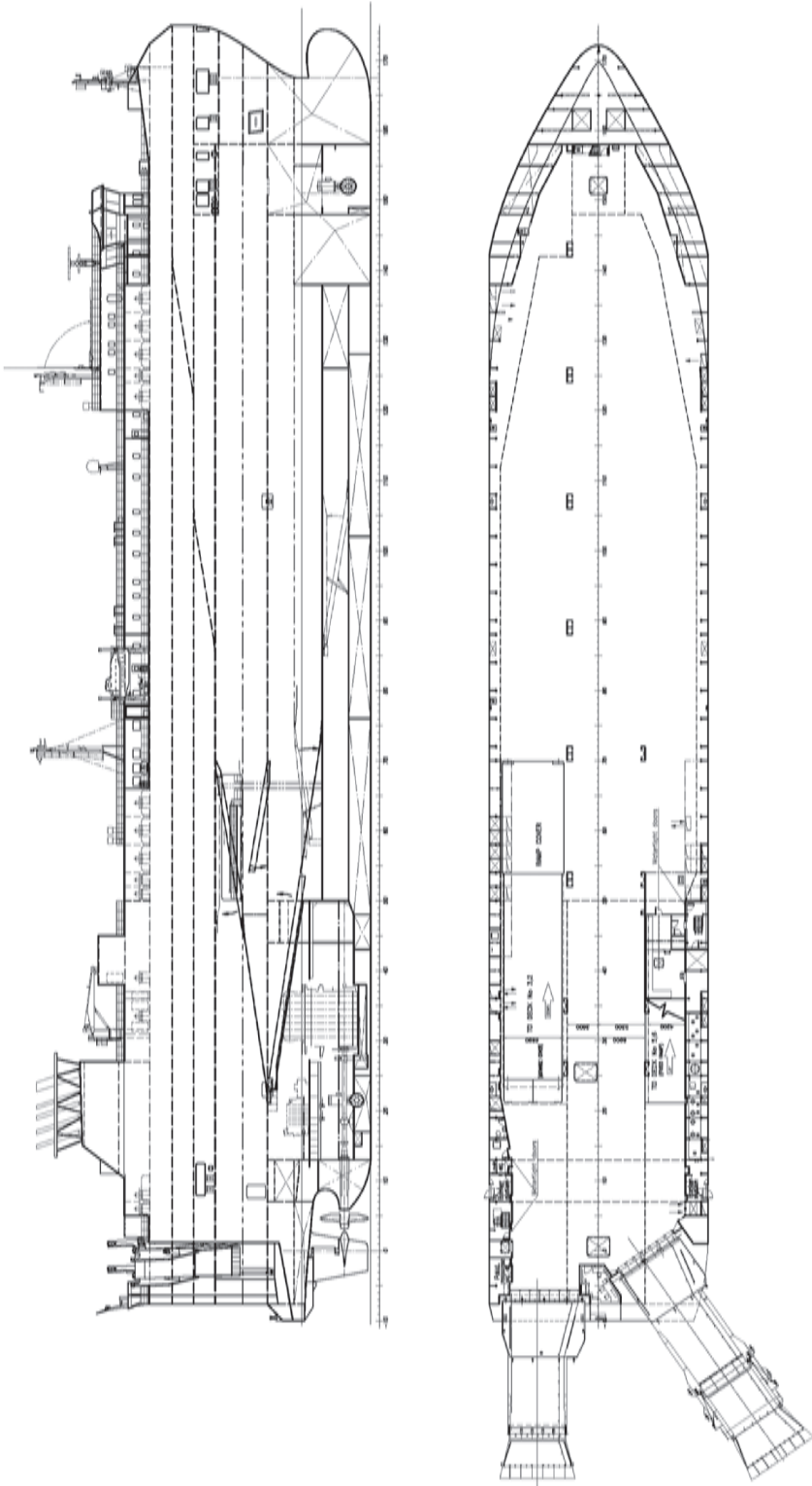

LOA = 148.00 m, LBP = 134.00 m, Bmld = 25.00 m, D = 25,20 m

CAR-CARRIER

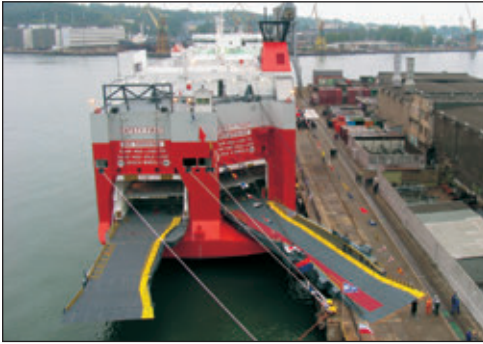

cars but trucks, knock-down car units, buses, containers, agricultural and construction machinery, and heavy project cargoes. The success of this new breed of ship and the growth of the trades they serve owe much to the efficiency of ro-ro access/transfer installations in loading, stowing and discharging operations. A typical outfit is based on a stern quarter ramp/door; side ramps/doors and internal hoistable decks and the major players in cargo handling equipment are MacGREGOR and TTS.

The largest deep-sea car carriers in service can carry up to 8000 car equivalent units (CEU).

Car decks – Light decks fitted in ferries and ro-ro vessels. Except for pure car carriers, car decks are usually designed to be movable. They may be stowed away when not required. There are three types of car decks and platforms; hoistable decks, liftable decks and side-pivoting decks.

Hoistable car deck – A hoistable car deck has a number of separate panels hinged together. At each end, access ramps with entering flaps are provided. The deck is operated by means of a drive system consisting of a wire and hydraulic jigger winch mounted externally inside the ship structure, or internally into panels. The panels are stowed below the deck above.

Liftable car decks – Liftable car decks have no integral lifting mechanism but are deployed by a mobile scissors lift. As a result, the maintenance requirements are minimal. When not required, the panels are stowed close against the deckhead above and locked in place by semi-automatic locking devices. When carrying cars, the mobile scissors lift is moved under each panel in turn and lowers it to required position. In a typical arrangement with the liftable deck in its intermediate position there will be clear heights of 1.7m above and 2.4m below. In its lower position the clear heights are 2.0m above and 2.1m below. See also **Corex panels**.

Car deck ramp – A one section ramp with flaps, integrated in a fixed or hoistable **car deck** panel, or just hinged or connected to the car deck edge. The operation is usually achieved by a wire and sheave arrangement, connected to hydraulic cylinders or jigger winch. It can also be achieved by direct-acting hydraulic cylinders. The ramp can be raised or lowered even when carrying the full car load.

Carbon capture and storage (CCS) – Process of trapping carbon dioxide produced by burning fossil fuels or any other chemical or biological process and storing it in such a way that it is unable to affect the atmosphere.

Carbon dioxide (CO₂) – Colourless extremely harmful gas that is heavier than air. It is stored in a liquefied state in fire extinguishers and is sometimes used as a refrigerant.

Carbon dioxide (CO₂) flooding system – A fixed installation designed to displace the oxygen in the protected space and thus extinguish the fire, usually used to fight fires in engine rooms, boiler rooms, pump rooms and holds. The system normally consists of a series of large CO₂ cylinders. The CO₂ is supplied from the cylinder manifold to suitable points with diffusing nozzles. The discharge valve is located in a locked cabinet. Opening the cabinet activates an alarm to give personnel time for evacuation. Since the effectiveness of fixed CO₂ fire fighting system diminishes the longer the fire burns, the speed is essential if CO₂ is to be effective.

Note: Before CO₂ system can be activated, engines need to be shut off, the machinery space needs to be evacuated, all openings and vent need to be shut and total evacuation has to be verified. Consequently, it can take 20 minutes or longer from the time of a fire

Carbon footprint

is spotted to activate the system. Such delay not only allows fire to spread freely causing considerable danger to personnel and damage to equipment, but also makes a vessel lose its manoeuvrability.

Further reading: *ABS Guidance Notes on "Fire-Fighting Systems", can be downloaded from www.eagle.org*

Carbon footprint – Amount of carbon dioxide and other carbon compounds emitted due to the consumption of fossil fuels.

Carbon monoxide (CO) – An odourless, colourless and toxic gas. Because it is impossible to see, taste or smell the toxic fumes, CO can kill you before you are aware it is in your home. At lower levels of exposure, CO causes mild effects that are often mistaken for the flu. These symptoms include headaches, dizziness, disorientation, nausea and fatigue. The effects of CO exposure can vary greatly from person to person depending on age, overall health and the concentration and length of exposure.

Cardan shaft – A mechanical arrangement which provides flexibility in the alignment of a driving and driven shaft, i.e. a flexible coupling.

Cardinal points – The four main points of the compass: north, east, south and west.

Cargo – The freight carried by a ship.

Cargo access/transfer system – Cargo access equipment such as stern ramps, side ports, bow doors, etc. See also **Ro-ro cargo handling gear**.

Cargo area – The part of the ship that contains cargo holds, cargo tanks, slop tanks and **cargo pump-rooms** including **pump-rooms**, **cofferdams**, ballast and **void spaces** adjacent to cargo tanks and also deck area throughout the entire length and breadth of the part of the ship over the above-mentioned spaces, (SOLAS).

Where independent tanks are installed in hold spaces, cofferdams, ballast or void spaces at the after end of the aftermost hold space or at the forward end of the forward most hold space are excluded from the cargo area.

Cargo containment system of gas carrier – The arrangement for containment of cargo including, where fitted, a **primary** and **secondary barrier**, associated insulation and any intervening spaces, and adjacent structure if necessary for the support of these elements. If the secondary barrier is of the hull structure it may be a boundary of the hold space, (IGC Code).

Cargo control room – A space used for the control of cargo handling operations.

The procedures of loading and unloading, pump control, heating control and monitoring of the cargo conditions and cargo-handling equipment is carried out and monitored from the cargo control room.

Cargo cranes – Shipboard cranes of various types and capacities are still required for multi-purpose cargo vessels, geared bulk carriers, feeders, reefers, heavy lift vessels and some forest product carriers. Manufacturers offer crane designs and special handling attachments (container spreaders, rotators and grabs) to suit all dry cargo trades.

Computer-based cargo spotting systems enable even relatively unskilled operators to cope with the pendulum effects and centrifugal forces. They also help in keeping containers or other cargo units constantly aligned with a given axis, regardless of slewing motion and other external forces. Such electronic aids substantially improve productivity. Some owners report a doubling of the hourly container-handling rate. Other benefits include: reduced operator fatigue, improved safety and lower cargo and ship structure damage.

Among the design criteria in specifying cranes for geared container ships and multi-purpose dry cargo tonnage is safe working load (SWL) of 36-40t. A two-wire configuration with widest possible jib head is preferred for easier cargo spotting and increased stability. Another important factor is the need to create the maximum possible container stowage space on deck. Thus the crane is expected to occupy no more than one container slot (2.4m with); a small minimum luffing radius (less than 2.4m) is also valued so that containers stowed closest to the crane can be handled. Internal access to the crane is essential, and cargo lighting will normally have to be fitted at the top of the crane housing.

Forest product carriers are required to transport and handle a variety of cargoes, including packaged sawn timber, logs (bundled or loose), and refined products such as pulp, paper and boards. The cranes must therefore be suitable for working with special attachments like clamps, multi-lifts and frames.

Mast cranes for dedicated heavy lift and project cargo vessels are a specialty of the Dutch company Huisman-Itrec which has supplied over 30 such units with lifting capacities up to 800t since developing the concept in the early 1980s. Deliveries have included eight 275t capacity cranes for a recent newbuilding class for BigLift shipping. Each of the four 8874dwt vessels in the series is equipped with two rotating mast cranes, one located aft to port and other forward to starboard. Working tandem, the pair can handle loads up to 500t, the relatively long jibs securing outreach approaching 28m. See also **Cranes**.

Cargo handling equipment – Equipment used for loading/discharging operations: e.g. **cargo cranes**, side-loading system with conveyors, sideshifters, elevators, belt conveyors, **ro-ro cargo handling gear** and cargo pumping systems.

Cargo handling equipment varies depending upon the type of cargo. Tankers are fitted with pumping systems and pumps, with small cranes to handle hoses from shore, and with tank-cleaning machines and inert-gas generating systems. Most dry-bulk carriers depend on shoreside facilities for cargo loading and discharge, but some bulk carriers have self-unloading features with conveyors below the cargo holds, or with cranes on deck. Reefer vessels are designed with refrigerated cargo holds fitted with large cargo-refrigeration systems.

Cargo handling equipment of a typical 138,000m³ LNG tanker

The ship has four membrane type cargo tanks. A tripod mast is built inside each tank with the filling line and two 1700 m³/h electric, submersible pumps attached. Complete discharge can be done within 12 hours, with loading handled by shore pumps after the tanks have been pre-cooled by a LNG spray. Vapour produced during these processes is returned to shore using two 32,000 m³/h compressors, a 26,000 kg/h main vaporiser and two heaters. Forced boil-off and delivery of gas fed to the propulsion system are achieved by two 8500 m³/h compressors and a 7600 kg/h forcing vaporiser combined with 540kW heater. Inerting of the insulated space and cargo tanks is accomplished by means of two 90 Nm³/h **nitrogen generators** and a 14,000 Nm³/h **inert-gas generator**. Two 1250 m³/h vacuum pumps, four 50 m³/h stripping/spray pumps, and a 550 m³/h emergency cargo pump are also fitted.

Cargo handling equipment on a VLGC – A Very Large Gas Carrier has normally the capacity to load about 80,000m³ of LPG. In order for the gas carrier to safely load, unload and carry liquefied gases a set of systems and equipment installations are required: a VLGC is equipped with 4 IMO type A tanks of prismatic shape located below deck. The tanks are self-supporting and structurally independent of the ship's hull. Each tank is enclosed in a cargo hold and is bounded by the transverse bulkheads, the double

bottom, the ship's sides and the main deck. The tanks are resting on the double bottom on specially constructed supports. They are stiffened against rolling and pitching on the bottom and on the top, against rolling and floating. Each tank is equipped with a dome protruding the deck level. All connections for piping and equipment to the tanks are arranged through this dome. The equipment associated with cargo handling operations are cargo pumps, cargo booster pumps, cargo heater and vaporizer and cargo reliquefaction unit.

Cargo handling spaces – Pump rooms and other enclosed spaces which contain **cargo handling equipment** and similar spaces for cargo handling.

Cargo hatch – A general term applied to any deck opening leading to the cargo holds.

Cargo list – A record of the goods accepted for loading on one vessel.

Cargo Manifest – A manifest that lists all cargo carried during vessel voyage.

Cargo manifold – The terminal point of the tanker deck piping. It consists of a number of pipes. Each of them branches off into two or more open ends for cargo loading or discharge.

Cargo monitoring – Monitoring of liquid cargo includes level gauging, temperature monitoring, and pressure measurement.

Cargo Plan, Stowage Plan – A plan showing the distribution of all cargo parcels stored on board of a vessel for a voyage. Each entry on the plan details the quantity, weight and port of discharge. A plan presenting the quantities and description of the various grades carried in the ship cargo tanks after the loading is completed.

Cargo port, side port – An opening in the ship side provided for loading or discharging cargo in tween-decks.

Cargo pump-room – A space housing pumps and their accessories for the handling of the products covered by **IBC Code**.

Cargo pumping system of the 22,000dwt product tanker CHEMBULK SAVANNAH

The cargo pumping system includes 24 Wärtsilä Svanehoj cargo pumps, driven by electric motors under frequency converter control. Pumps handle cargoes with a maximum density of 1.5t/m³. Using 12 Vacon frequency converters, the system is designed for a maximum of 12 pumps to be operated simultaneously, either under remote control from the cargo control room or under local control from the converter switchboard front panel. The cargo piping system is designed for a maximum pressure of 16 bar, with automatic switch off, if a valve in the discharge system is closed in error.

Cargo rails – Usually long and narrow enclosed spaces on PS and SB of an offshore vessel's open cargo deck. Items usually located in the cargo rails: loading/discharge stations, pipes going to loading/discharge stations, ventilation pipes from tanks, ventilation for spaces below deck, emergency exits from below, escape routes and passage for carrying injured person on stretcher in case the cargo deck is fully blocked with cargo, electrical cables, mooring equipment.

Cargo residues – Remains of any cargo on board that cannot be placed in proper cargo holds (loading excess and spillage) or which is left in cargo holds and elsewhere after unloading procedures are completed (unloading residual and spillage).

Cargo securing devices – All fixed and portable devices used to secure and support **cargo units**.

Cargo Securing Manual (CSM) – The manual required on all types of ships engaged in the carriage of all cargoes other than solid and liquid bulk cargoes. Cargo units, including

containers, shall be loaded, stowed and secured throughout the voyage in accordance with Cargo Securing Manual approved by the Administration.

Further reading: *MSC/CIRC. 745 Guidelines for the Preparation of the Cargo Securing Manual.*

Cargo segregation – The separation of liquid cargoes to avoid cross contamination.

Cargo service spaces – Spaces within the cargo area used for workshops, lockers and storerooms of more than 2m², used for cargo-handling equipment, (IBC Code).

Cargo ship – Any ship designed to transport goods and no more than 12 passengers.

General cargo ship – Ship constructed for carrying of general cargo not packed in containers.

*A vessel with the GL class notation **EQUIPPED FOR CARRIAGE OF CONTAINERS** is the General Cargo Ship carrying containers occasionally or as part cargo only, and equipped with the appropriate facilities. Such a vessel can have long holds to accommodate containers of different types and flush type lashing sockets on tank top and walls.*



Multi-purpose cargo ship – The vessel designed for transport of wide range of commodities such as general cargo, forest products, dry bulk, grain, steel coils and usually equipped for transport of containers. Such vessels have tank top strengthened for heavy cargo and grab operation. Permissible tank top loading 10-20t/sqm.

*A vessel with the GL class notation **MULTI-PURPOSE DRY CARGO SHIP** is the ship constructed for the carriage of general and bulk cargo.*

Cargo Ship Safety Construction Certificate – The certificate required to be carried on board of cargo ships of 500 gross tonnage and over.

Cargo Ship Safety Equipment Certificate – The certificate required to be carried on board of cargo ships of 500 gross tonnage and over. A Record of Equipment for the Cargo Ship Safety Equipment Certificate (Form E) shall be permanently attached.

Note: *The form of the certificate and its Record of Equipment may be found in the GMDSS amendments to SOLAS 1974.*

Cargo Ship Safety Radio Certificate – The certificate required to be carried on board of cargo ships of 300 gross tonnage and over. A Record of Equipment for the Cargo Ship Safety Radio Certificate (Form R) shall be permanently attached

Note: *The form of the certificate and its Record of Equipment may be found in the GMDSS amendments to SOLAS 1974.*

Cargo Space Information – As built documentation of cargo spaces. It should consist of the following documents:

1. Cargo space general description
2. Container Stowage Plan
3. Cargo Hold Scaling for Bale
4. Cargo Hold Scaling for Grain.

Cargo spaces – Spaces used for cargo, cargo oil tanks, tanks for other liquid cargo and trunks to such spaces, (SOLAS).

Closed ro-ro cargo spaces – Ro-ro spaces which are neither open ro-ro spaces nor weather decks, (SOLAS).

Closed vehicle spaces – Vehicle spaces which are neither open vehicle spaces nor weather decks, (SOLAS).

Open ro-ro cargo spaces – The ro-ro spaces which are either open at both ends or have an opening at one end, and are provided with adequate natural ventilation effective over their entire length through permanent openings distributed in the side plating or deckhead or from above, having a total area of at least 10% of the total area of the space sides, (SOLAS).

Open vehicle spaces – The vehicle spaces which are either open at both ends or have an opening at one end, and are provided with adequate natural ventilation effective over their entire length through permanent openings distributed in the side plating or deckhead or from above, having a total area of at least 10% of the total area of the space sides, (SOLAS).

Ro-ro spaces – Spaces not normally subdivided in any way and normally extending to either a substantial length or the entire length of the ship in which motor vehicles with fuel in their tanks for their own propulsion and/or goods (packaged or in bulk, in or on rail or road cars, vehicles (including road or rail tankers), trailers, containers, pallets, demountable tanks or in or on similar stowage units or other receptacles) can be loaded and unloaded normally in a horizontal direction, (SOLAS).

Vehicle spaces – Cargo spaces intended for carriage of motor vehicles with fuel in their tanks for their own propulsion, (SOLAS).

Cargo tank – The liquid-tight shell designed to contain the cargo.

Deck tank – A cylindrical gravity cargo tank, secured to transverse cradles on the cargo tank deck and used for specialised cargo.



Gravity tank – A cargo tank with design pressure not exceeding 0.7 bar gauge.

Independent tank – A tank entirely separated from the hull structure and not contributing to the strength of the ship. Tanks of this type are used for transport of liquefied gases, molten sulphur and **bitumen products**.

Integral tank – A tank that contributes directly to the strength of the hull structure and is contiguous with it.

Pressure tank – An independent cargo tank type C designed to withstand an internal pressure in excess of 0.7 bar gauge.

Separate tank – A gravity cargo tank which is not fully integrated into the hull structure but has a limited degree of attachment, for example, to transverse primary members only.

Cargo tank of gas carrier – The liquid-tight shell designed to be the prime container of the cargo and includes all such containers whether or not associated with insulation or **secondary barriers** or both, (IGC Code). The IGC Code categorizes cargo tanks into five main types; integral tanks, membrane tanks, semi-membrane tanks, independent tanks, and internal insulation tanks. In addition, independent tanks include a further three sub-categories of tanks referred to as Type A, Type B and Type C, while internal insulation tanks include two sub-categories of Type 1 and Type 2 tanks.

Independent tanks – Independent tanks are self-supporting; they do not form a part of the ship hull and are not essential to the hull strength. There are three categories of independent tanks: type A, type B and type C (pressure vessels).

IMO type B independent tanks were developed by Moss Rosenberg, using spherical tanks, and by Ishikawajima Heavy Industries, using self-supporting prismatic tanks. The US classification society ABS has very recently given approval in principle to a new type B cylindrical tank with spherical dished ends that has been developed by Houston-based Ocean LNG Inc.



Integral tanks – Integral tanks form a structural part of the ship hull and are influenced in the same manner and by the same loads which stress the adjacent hull structure.

Internal insulation tank – Internal insulation tanks are not-self-supporting and consist of thermal insulation materials which contribute to the cargo containment and are supported by the structure of the adjacent inner hull or of an independent tank. The inner surface of the insulation is exposed to the cargo.

Membrane tank – Membrane tanks are not-self-supporting tanks which consist of a thin layer (membrane) supported through insulation by the adjacent hull structure. The membrane is designed in such a way that thermal and other expansion or contraction is compensated for without undue stressing of the membrane. Various systems were specially developed by French designers Gaz Transport and Technigaz, which merged in 1994 to create GTT. See also **Membrane containment system**.

Self-supporting prismatic tank – The independent prismatic shape IMO type B (SPB) tank developed by IHI. The most recent installation was in a pair of 87 500m³ LNG carriers built in 1993 (POLAR EAGLE and ARTIC SUN). As with the Moss Rosenberg tanks, the SPB tanks are prefabricated and subsequently installed inside the inner hull as complete units. They are rectangular in shape, built of aluminium plates with a thickness of 15 to 25mm and covered with heat insulating material blocks. At the bottom of the tanks, supporting blocks made of reinforced plywood are fixed and mounted on steel supports on the double bottom structure.

Each tank has an internal centreline **bulkhead** and a subdividing swash bulkhead which eliminates sloshing problems experienced with partially-filled tanks. Access for inspection and maintenance to the inner hull is made easy if the vessels have a completely flat weather deck and double hull.

Semi-membrane tank – Semi-membrane tanks are not-self-supporting tanks in the loaded condition and consist of a layer. Parts of the layer are supported through insulation by the adjacent hull structure, whereas the rounded parts of this layer connecting the above-mentioned supported parts are designed also to accommodate the thermal and other expansion or contraction.

Cargo tank gas-freeing – Gas-freeing consists of series of operations in which cargo vapour is replaced with **inert gas** which in turn is purged with air to prevent explosion hazard.

Cargo tank inerting – Inerting is done by supplying an **inert gas** to cargo tanks and associated piping in order to prevent explosions during cargo handling operations. Two types of inert gas are commonly used: gas produced by an **inert gas generator** and nitrogen.

Cargo tank stripping – The final stage in bulk liquid pumping from a **tank** or pipeline. To achieve this, it is often necessary to list the ship to avoid suction loss. A large stern trim assists in draining, particularly if product is trapped in the centreline bulkhead corrugations.

Chemical cargoes, which create threat to the marine environment, must be discharged until there is virtually no residue left on board. Modern chemical tankers are designed from the outset with efficient stripping in mind; cargo tanks are smooth-walled, bulkheads are either corrugated or provided with stiffening located in the adjacent spaces. The clearance between the impeller of a submerged pump and the bottom of suction well can be as small as 20 mm. The cargo left in each pump and its piping can be stripped to shore by blowing air or nitrogen through the system. In this arrangement, residue quantities in the region of 50 litres per tank are achievable.

Cargo tank venting – Cargo tanks of a chemical **tanker** are required to be provided with venting systems to prevent both over and under pressurisation of the tank. Two types of venting system are specified by the Code, namely “open” and “controlled”.

Open tank venting system – An open venting system is for cargoes which are of little or no flammable or toxic hazard.

Controlled tank-venting system – Controlled venting systems are required to be fitted in all tanks carrying cargoes emitting harmful or flammable vapours. Each tank must be fitted with pressure/vacuum valve to relieve over-pressure or under-pressure.

Cargo unit – A vehicle, container, flat, pallet, portable tank, package unit, or any other entity, etc., and loading equipment, or any part thereof, which belongs to the ship but is not fixed to it.

Carlings – Supports usually of flat plate, welded in a fore and aft direction between transverse deck beams to prevent distortion of the plating.

Carousel – A large reel with vertical axis used for storage of cables or flexible pipes onboard of **offshore support vessels**. Carousels can be built into existing tanks or mounted on deck and are loaded via a loading/discharge arm which guides the cable around the cone of the carousel as it turns. Carousels are used for storage during transportation and installation of flexible pipe, umbilicals, risers and other products for offshore applications. A carousel comprises a lower flange located on a central king pin, a hub and an upper flange. The position of the upper flange is adjustable and the flange is locked in place making use of special spacer bars.

“Multi-purpose support vessel TOISA PERSEUS is equipped with two 16m diameter under-deck carousels, each with storage capacity of 1225t of product at a maximum bending radius of 4.5m. Product is laid from the carousels via single main hatch in the deck which is surrounded by a 1m high coaming to provide protection from water on deck and increase crew safety.”

Carrier – This term, usually refers to a steamship company, but can also refer to vessel.

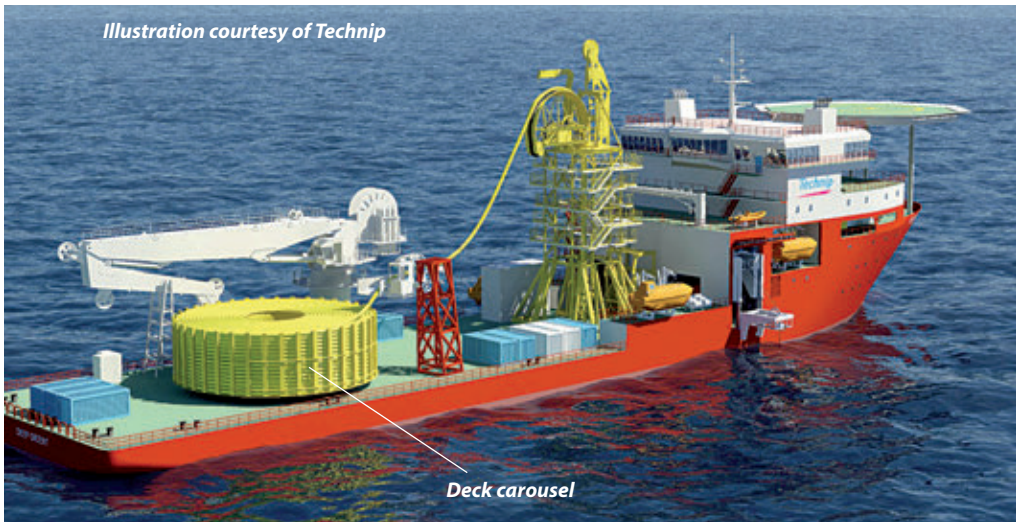

Cascade protection – The application of protective devices in which the device nearest to the source of power has short circuit ratings equal to or in excess of the maximum prospective short circuit current, while devices in succeeding steps further from the source have lower short circuit ratings.

Cascade Regasification System

In this system, LNG is heated by propane in a closed loop and the propane is heated by seawater. In situations where the seawater is too cold to supply all the required heating energy, additional heat can be introduced. The cascade concept is recommended instead of directly heat exchanging with seawater. LNG heat exchanged directly with seawater increases the risk of freezing the seawater in the heat exchanger. Propane as a secondary medium is suggested because of its thermodynamic properties with a low freezing point.



Wärtsilä Hamworthy regasification modules for Hoeg 170,000m³ FSRU

LNG enters a cryogenic pump capable of producing the required send-out pressure (e.g. up to 130 bar has been studied). LNG at the required discharge pressure is heated in two stages.

In the first stage LNG is heated from -160°C to -10°C in a compact printed circuit heat exchanger with propane as a heating medium. In the second stage, LNG can be heated further using seawater as a heating medium in a shell and tube heat exchanger.

In the LNG/Propane heat exchanger, heat is exchanged against propane circulating in a closed loop. The propane enters the heat exchanger at approx. 0°C at 4.7 bar as gas. In the heat exchanging process propane is condensed, and leaves the exchanger in a liquid state at approximately -5°C. The propane in the closed loop is then pumped by the circulating pump and heated against seawater in titanium semi welded plate heat exchangers. In these heat exchangers, the propane is evaporated and heated to 0°C before returning as gas to the printed circuit heat exchanger.

For further information please visit www.wartsila.com

Casing –

1. The covering or bulkheads enclosing portion of vessel, for example, the boiler and/or engine room casing.
2. A pipe used to line and seal the **well** and prevent the collapse of the borehole. A number of casing lengths are used in decreasing diameters.

Cassette – A wheelless steel platform used to transport paper reels on **ro-ro** forest products. Terminal tractors use lift-trailers to handle it. The 12.2m long cassette has a maximum capacity of 80t, but normally carries 45/60t. Paper reels are pre-lashed at the paper mill onto the cassette eliminating on-board lashings. Cassette can also be used for container handling and two 40-ft units can be carried on top of each other. See also **Rolux wheelless cassette system**.

Cassette carrier – A **ro-ro** vessel designed to transport **cassettes**. The cassettes are put onto the vessel using terminal tractors with lift-trailers. They are hydraulically-raised and lowered trailers which slide through the centre of a cassette to load and discharge it from the vessel.

Cast iron – Iron with the carbon content of 1.8 to 4.5%. White cast iron is hard and brittle. Grey cast iron is softer, machinable and less brittle.

Castling – The pouring of molten metal into a mould of the desired shape.

Casualty – Case of death or serious injury to a person in an accident or shipping disaster, also used about a distressed vessel.

Catamaran – A vessel with two hulls and a deck structure between them. The relatively slender hulls of the catamaran lead to reduced wave-making resistance which compensates well for the increased frictional resistance associated with their increased wetted surface.

Catamaran fast ferry FRANCISO

The world's fastest ferry FRANCISCO was delivered in 2013 to the Argentinean owner Buquebus from the Australian shipbuilder Incat Tasmania Pty Ltd. The vessel was named in honour of the Buenos Aires born Pope of the Catholic Church. The vessel operates on the River Plate, between Buenos Aires, Argentina, and Montevideo, Uruguay.

The ship is capable of sailing at a speed of 51.8kt with a deadweight capacity of 450t. The propulsion system consists of two GE Energy LM2500 gas turbines, specially designed to



FRANCISO is the first dual fuelled fast ferry to operate with LNG as the primary fuel

burn both LNG or marine distillate and rated 22MW each, and a pair of Wärtsilä LJX 1720 SR axial waterjets. Wärtsilä has also supplied an advanced propulsion control system Lipstronic 7000.

The power plant uses marine distillate for start-up and during the ensuing minutes until the heat exchangers have produced enough gas from the LNG to allow changeover to LNG fuel. On arrival in port, the gas turbines revert to distillate for the vessel manoeuvring phase. The distillate will also serve as standby fuel.

Each prime mover and ancillary equipment is housed within a steel enclosure in each hull, and a 7:1 ratio ZF reduction gearbox is interposed on each driveline to a Wärtsilä LJX 1720SR axial waterjet. Configured for steering and reverse, the Wärtsilä design is notable for its comparatively small size, given the power input entailed. The proprietary Lipstronic 7000 system controls and indicates the steering angle, bucket position and impeller speed, and can be operated either by joystick or autopilot.

Two 200kW Caterpillar C9 gensets are installed to start the gas turbines, while another four 340kW Caterpillar C18 gensets are utilised for domestic use.

FRANCISCO has been fitted with two 43m³-capacity, super-insulated LNG storage tanks and associated cold boxes, with vaporisers, pumps, valves, bunker stations, control systems, safety detectors, a glycol circuit and a heat management system for the turbine exhaust gases. A cold box is effectively an airtight enclosure containing the wherewithal for fuel processing. Each hull of the catamaran has one LNG tank. Positioned amidships in a compartment immediately above the double bottom marine distillate bunker tanks, the gas tanks are of double-walled, stainless steel construction. They embody proprietary, multilayer composite vacuum insulation to maximise fuel capacity and maintain the LNG in its liquid state at a temperature of -163°C. Changeovers between LNG and distillate will be automatically controlled and will be performed as a 'seamless' operation.

The tanks provide for up to four hours of high speed operation, affording the requisite capacity to cover the round trip of 250 nautical miles on the River Plate service, so that bunkering need only be undertaken at one of the terminal ports. This is carried out at Buenos Aires from trucks drawing cryogenic tank trailers. The ship's system has been designed to facilitate LNG refuelling in less than one hour, with simultaneous intake from two LNG trailers.

FRANCISCO accommodates 955 passengers and 150 cars on four tiers. Tier 1 is the vehicle deck providing an area of 4.5m in length and 2.3m in width for each car and an axle load of 2t each.

Tier 2 is subdivided into three areas. The first area is comprised of an economy-class aft lounge with seating areas and a bar, the second area provides a duty-free shop lobby featuring toilet facilities and the third area features a duty-free shop.

Tier 3 is subdivided into four areas. The first area comprises a tourist-class aft lounge with seating areas and a bar. The second area features a main foyer with a reception area, business lounges, and toilet facilities. The third area features a business-class mid lounge with seating areas, a bar, and toilet facilities. The fourth area is a first-class forward lounge featuring seating areas, a bar, a VIP lounge, and toilet facilities. The wheelhouse of the vessel is on Tier 4.

Length, oa: 99.00m, Breadth, mld: 26.94m, Depth, mld: 6.65m, Draught design: 3.09m, Deadweight design: 450dwt, Lightweight: 1063.2tonnes, Gross tonnage: 7109, Propulsion power: 2x22MW, Service speed at 85% MCR: 50 knots, Crew: 24.

Catastrophic release – Term used in the offshore industry for a major hydrocarbon release that results from uncontrolled developments and that may lead to serious danger to personnel.

Catenary – The curve produced by a uniform, flexible wire or chain when suspended by its ends. Anchor chains from a **buoy** or a towing wire between vessels will take this shape. It provides resilience to any sudden stresses.

Catenary Anchor Leg Mooring – The **single point mooring** system. A catenary anchor leg mooring system consists of a large buoy anchored by catenary mooring lines. The **Floating Installation Vessel** is moored to the buoy by soft hawsers or a rigid **yoke arm**.

Catering outfit of the ro-ro passenger ferry RODIN

SeaFrance **ro-ro** passenger ferry RODIN has become the largest and fastest ferry to operate on the Dover-Calais route. The vessel was built at Rauma Aker Finnyards in Finland and features a comprehensive MacGREGOR catering outfit.

The catering system covers a total area of 772m² and comprises three bars, three pantries, three buffet areas and two galleys (one for the self-service and the crew messroom, and the other for a 60-seat a la carte restaurant).

Passenger area is situated on the two upper decks (7 and 8). The main galley is on deck 8 and can prepare about 500 meals per crossing to serve the 345-seat self-service cafeteria, the 160 seat commercial drivers' open buffet restaurant, and crew messroom. Two bars on deck 7 (310 seat and 400 seat) serve hot and cold snacks as well as drinks and the larger can be used for banquets for up to 250 people.

Cathelco anti-fouling system – The anti-fouling system based on the electrolytic principle. It consists of copper and aluminium anodes which are fed with an impressed electrical current from a control panel. The anodes are usually mounted in pairs in the ship **sea chest** or **strainer** where they are in direct contact with the flow of water entering the seawater lines. In operation, the copper anode produces ions, which are transported by the seawater and carried into the pipework system. Although the concentration of copper in solution is extremely small – less than 2 parts per billion, it is sufficient to prevent marine life from settling and multiplying. At the same time, the slow dissolution of the aluminium anode produces ions which spread throughout the system and produce an anti-corrosive layer on the internal surfaces of pipes.

Cathode – The negatively charged metal surface and the non-corroding or protected part of an electrochemical corrosion cell.

Cathodic protection – Cathodic protection is a system of preventing corrosion by forcing all surfaces of a structure (e.g. hull) to be cathodes by providing external anodes. It can be achieved by superimposing on the hull an impressed current provided by a remote power source through a small number of inert anodes (**impressed current cathodic protection**). Also accomplished by fitting aluminium, magnesium or zinc anodes in tanks or underwater portion of a ship, which waste away by galvanic action (**sacrificial anode cathodic protection**).

Catwalk, walkway – A narrow, raised platform or pathway used for passage to otherwise inaccessible areas on a ship permitting fore and aft passage when the main deck is awash.

Caulking – Plastic deformation of weld and base metal surfaces by mechanical means to seal or obscure discontinuities.

Cavitation – Bernoulli's law indicates that the higher the velocities of water particles, the lower the pressure in that same water. In case this pressure drops below the vapour pressure, the water will vaporize on a local scale. This phenomenon is called cavitation and has a close resemblance with the phenomenon of boiling; however cavitation occurs at low pressure rather than at high temperature. Cavitation could occur on any location with high water velocities, for example on parts of propellers, rudders, shaft brackets, sonar domes, hydrofoils, etc.

Cavitation can be classified by;

- location: tip cavitation, root cavitation, leading edge or trailing edge cavitation, suction side cavitation, face cavitation, etc.,
- form: sheet cavitation, cloud cavitation, bubble cavitation, vortex cavitation,
- dynamic properties: stationary, instationary or migrating cavitation.

Cavitation manifests itself by noise, vibration, thrust reduction and material erosion of the propeller blades, struts and rudders. The danger of cavitation on either propeller or appendages increases for higher ship speeds and higher propeller loadings.

Cavitation damage – Degradation of metal surfaces, characterized by pitting occurring when very turbulent fluids come into contact with metal surface, and associated with the formation and collapse of cavities in the liquid at solid – liquid interface.

Cavitation erosion – The erosion of material, for example backside of the blades usually attributed to the collapse of cavitation bubbles.

Cavitation number – A non-dimensional parameter for the dynamic pressure in a fluid; also to estimate the cavitation probability in a fluid.

Cavitation tunnel – A facility used for propeller **cavitation tests**. This is a vertical water circuit with large diameter pipes. A parallel inflow is established. With or without a ship model, the propeller, attached to a dynamometer, is brought into the flow, and its thrust and torque is measured at different ratios of propeller speed to inflow velocity. To ensure similarity to the full-scale propeller the pressure in the tunnel is lowered to produce the correct **cavitation number** at the propeller axis.

Cavitation tunnels are equipped with stroboscopic lights that illuminate the propeller intermittently. Propeller blades are always seen at the same position and the eye perceives the propeller and cavitation patterns on each blade as stationary. See also **HYKAT**.

Extremely large cavitation tunnels were built in France, the United States and in Germany to reduce the consequences of scale effects. Models (ships, submarines, torpedoes, etc.) are

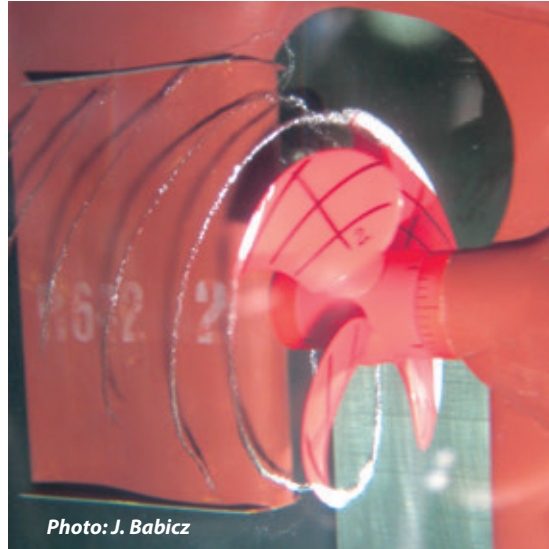

Photo: J. Babicz

tested with the complete hull-propulsion appendage as an integrated unit, and tests are carried out at high Reynolds numbers, that is with high velocities.

Cavitation tests – Cavitation tests are performed in a **cavitation tunnel** using a dummy afterbody model and simulated full-scale **wake field** or a full model. Tests include cavitation observation, measurement of pressure fluctuations, erosion tests and measurement of propeller-induced forces and noise.

Ceiling systems – Suspended metal ceilings are suitable for public spaces (restaurants, shops, and theatres), cabins and corridors, storage rooms and offices. The ceilings are made mainly of aluminium and steel. Fireproof ceilings (B-0 and B-15 classes) are filled with fire-resistant wool.

Cement carrier – A single-skin or double-skin **bulk carrier** provided with a cement loading and discharging plant. Most vessels of this type use the principle that when air is pumped through a cement cargo, it acts as if it were liquid. In this way, cement can be loaded easily and, while discharging, can be moved readily to a central trunk at the bottom of holds.

Cement carrier KEDAH CEMENT II

According to **The Motor Ship** May 1996

The self-loading/discharging cement carrier KEDAH CEMENT II was built by Pan-United Shipyard, Singapore. The ship has four holds, each centrally divided by a longitudinal bulkhead. The cement-handling plant has been supplied by the German Company IBAU and is designed to handle two different grades of Portland cement, based on a specific gravity of airless cement of $1.1/1.4\text{t/m}^3$. There is a central loading station located amidships on the main deck with four fluidslides. Cement is loaded at a rate of about 1000 t/h, using air slides and gravity. High-pressure fans supply fluidisation air to the loading slides and distributors. Four electrically-driven piston blowers supply the aeration of the cargo holds.

Discharge of the cargo is from the bottom of the sloping holds through cement pumps onto a conveyor belt. The cargo hold bottoms are sloped 7° athwartships and 11° in the fore and aft direction. Each of the four electrically-driven cargo pumps has a capacity of 200t. Again,



Deck of the cement carrier KAKUSHO MARU

fluidisation of the cargo is necessary during discharge, especially since the cargo tends to settle and consolidate during transit. In this case, it is achieved by fluidisation air channels in the holds, which move the cargo towards the flow gate. The rate of discharge from each hold is controlled by the flow gate connected to the cargo pumps. The total distance covered by the conveyor belt is about 590m. This includes lifting the cargo up to 50m and eight 90deg bends are included in the belt run. Discharge at the ship side is through four cargo hoses, stowed on the main deck, when not in use and handled by a MacGregor-Haglund 15t crane.

Propulsion is by twin engines with a total output of 5279kW to give a service speed of 13.5knots. The engines drive through a double input/single output gearbox driving a 4-bladed 4.7m diameter CP propeller with a gear ratio of 1:4.2 to give a propeller speed of 135rpm. The gearbox is also equipped with two A van Kaick PTO rated at 2160kW each. To aid manoeuvrability the ship is fitted with a 640kW Wärtsilä Lips CP bow thruster rated at 10t.

Length, oa: 145.0m, Length, bp: 136.1m, Beam, mld: 22.0m, Depth, mld to the main deck: 12.20m, Draught design/scantling: 9.0/9.50m, Deadweight design/scantling: 16,000/17,300dwt, Cargo capacity: 3600m³, Output: 2x2650kW, Speed: 13.5 knots.

Centistokes – An established unit used for the measurement of **kinematic viscosity**. The accepted SI unit is m²/s and 1cSt = 10⁻⁶ m²/s.

Central control station (SOLAS) – A control station in which the following control and indicator functions are centralized:

1. Fixed fire detection and fire alarm systems
2. Automatic sprinkler, fire detection and fire alarm systems
3. Fire door indicator panels
4. Fire door closure
5. Watertight door indicator panels
6. Watertight door closures

7. Ventilation fans
8. General/fire alarms
9. Communication systems including telephones, and
10. Microphones to public address system.

See also **Control stations**.

Central Cooling Water System – Most cooling systems are made as central cooling ones, which means that there is only one or two large plate heat exchangers equipped with titanium plates. Titanium is the only material that can withstand seawater without corrosion damages. This means that the central cooler can operate without problems using seawater as the cooling medium for the internal freshwater cooling systems.

The typical central cooling water system consists of:

- the Seawater Cooling System,
- the Freshwater Low Temperature (FW-LT) System,
- the Freshwater High Temperature (FW-HT) System.

The FW-LT System is used for cooling: ME LO Cooler, Camshaft LO Cooler, Jacket Water Cooler, and Scavenge Air Coolers. The FW-HT System is used for cooling the cylinder liners, cylinder covers and exhaust valves of the main engine. **Freshwater generator** is installed for production of freshwater by utilising the heat in the jacket water-cooling system.

Centralized priming system – It consists of a suitably constructed tank which is maintained automatically under a vacuum by air exhausting units, with connections leading to the tank from each of the pumps concerned.

Centre of buoyancy – The centre of gravity of the displaced water. That is, the geometrical centre of the underwater part of the ship.

Centre of flotation – The geometric centre of the waterplane on which a vessel floats. A vessel pitches, or rotates (about a transverse axis) through this point, when moved by an external force.

Centre of gravity – The point at which the total weight of all the items which make up a vessel total weight may be considered as concentrated.

Centre of lateral resistance – The point through which the resultant of resistance of the immersed hull to lateral motion passes.

Centreline – A line of symmetry between the port and starboard sides of any vertical section or any horizontal section. The middle line of the ship extending from stem to stern at any level.

Centreline girder, centre girder – A vertical plate on the ship's **centreline** between the outer and inner bottom plating, extending the length of the ship.

Certificate of Registry – Held by the shipowner it indicates registration of the vessel and gives full details of the ship. It is not a document of title to the ship.

Certificate of Seaworthiness – When a classed vessel suffers damage, the **classification society** carries out a **seaworthiness** survey after repairs have been completed. When the Surveyors are satisfied as to the vessel seaworthiness, a certificate of seaworthiness is issued by the **classification society**.

Certificates for masters, officers or ratings – Certificates issued by a National Authority following passed examination; a specified period of sea service and completion of other courses or requirements.

Certified person – A person who holds a certificate of proficiency in survival craft.

Cetane number – A figure used to indicate the ignition quality of a fuel. The higher the cetane number, the shorter the time between fuel injection and its ignition.

Chafe chain, chafing chain

Chafe chain, chafing chain – A chain at the end of a towing line or Single Point Mooring **hawser**, normally guided through a chock at the edge of the tanker deck.

Chafing – The action of being fretted and worn by rubbing; applies to ropes, parts of the ship's structure, cargo and so on.

Chafing plate – A piece of plating fitted on such parts of the hull that are subjected to rapid wear by chafing.

Chain – Connected metal rings or links used for holding **anchor**, fastening timber cargoes, etc.

Chain drive – The use of a chain to drive the camshaft. A sprocket wheel is fitted to the **crankshaft** and the **camshaft** and an adjustable spring loaded wheel is provided for chain tightening.

“The chain drive is provided with a chain tightener and guide bars to support the long chain lengths.”

Chain locker – A compartment located under the **windlass** where the **anchor chains** are stowed. It is usually subdivided inside by a longitudinal **bulkhead**. Chain locker is to be made watertight to the weather **deck**. The arrangements are to be such that accidental flooding of the chain locker cannot result in damage to auxiliaries or equipment necessary for proper operation of the vessel nor in successive flooding into other spaces. Where means of access into the chain lockers are provided, they are to be closed by a substantial cover secured by closely spaced bolts. Doors are not permitted.

Chain pipe – A heavy pipe fitted directly under the **windlass** to lead the **anchor chain** to the **chain locker**.

Chain stopper, cable stopper – A fitting used to secure the **anchor chain** when riding at **anchor**, thereby relieving the strain on the **windlass**, and also for securing the anchor in



the housed position in the **hawse pipe. Chain stopper** usually consists of two parallel vertical plates mounted on a base with a pivoting bar or pawl which drops down to bear on a chain link.

A hinged bar is fitted in the chain stopper which may be dropped between two links of the chain in order to prevent the chain from running out when the windlass brake is released.

Chalking – The formation of a sandy, powdery layer on the surface of a paint film caused by disintegration of one or more components of the film due to weather and sunlight (ultra-violet radiation).

Change of Ownership (marine insurance) – When a vessel changes ownership or Management, the policy on the ship is cancelled automatically in practice unless the insurer agrees to continue cover. A *pro rata* daily return of premium is allowed for the unexpired term of the policy.

Channel bar – A rolled bar with a U-shaped cross section.

Charge air – A quantity of fresh air supplied to a diesel engine cylinder prior to compression.

Charging – Filling of the engine cylinder with a charge of fresh air ready for compression.

Chart -

1. A paper sheet or surface with a permanent record done by a recording instrument.
2. A map of the ocean or sea showing islands and coastal regions. Details of soundings, seabed, currents, etc., are also included.

Chart area – Part of the wheelhouse situated and equipped for adequate performance of voyage planning/plotting activities.

Chart room – A separate room or part of the **wheelhouse** where charts are stored; also used for navigation.



Photo: J. Babicz

Chart table/documentation workstation – Workstation where voyages are planned; in case of lack or failure of the automatic visual position indicator, it serves for fixing and logging the ship position.

Charter party – A written contract between the owner of a vessel and the person desiring to employ the vessel (**charterer**), setting forth the terms of the arrangement, freight rate and ports involved.

Charterer

Bare boat charter – A charter in which the bare ship is chartered without crew; the **charterer**, for a stipulated sum, take over the vessel for the stated period of time, with a minimum restrictions. The **charterer** appoints the Master and the crew and pays all running expenses.

Charterer – Cargo owner or another person/company who hires a ship for a particular voyage or a period of time.

Chartering – To hire a ship to carry goods/cargo.

Chartering agent – A shipbroker acting on behalf of charterer in negotiations about the chartering of a ship.

Check valve – A valve which permits the flow of liquid in only one direction, i.e. a non-return valve.

Checked plate – A plate used as floor, marked with raised diamond checkers or squares to provide good footing.

Chemical curing paints – Paints contain two components: the base and the hardener. Curing is obtained by mixing the base and hardener in defined proportions. A chemical reaction then occurs, causing cross-linking of the molecular chains. Once cured, these paints provide a very hard **film**.

Chemical tanker BOW SUN

According to **Significant Ships** of 2003

The BOW SUN, delivered by New Szczecin Shipyard in 2003, is one of the largest chemical tanker in the world. The ship is designed to carry IMO Type I, II and III chemicals, petroleum products, vegetable, animal and fish oils, and molasses. The ship provides 52,100m³ cargo capacity in 40 tanks, ranging in capacity from 350 to 2650m³.

The Norwegian company supplied a cargo pumping system that includes an independent deepwell cargo pump for each tank; 7x330m³/h plus 27x230m³/h. Each of the deck tanks has 100m³/h pump. Loading/discharging is possible through the midship manifolds at a maximum rate of 3000m³/h with each tank fitted with its own piping system.

All piping, valves and pumps are of stainless steel, like the two sets of heating coils fitted in each tank, which transfer hot water heated by steam in two heat exchangers. In addition, four of the cargo tanks are fitted with a thermal oil heating system.



Photo courtesy of Stocznia Szczecińska Nowa Sp. z o. o.

The ship has hull structure calculated for a 40-year fatigue life. The double-skin surrounds a cargo space divided by two longitudinal, and 17 transverse bulkheads, into 18 centre tanks, and 8 pairs of wing tanks, all built from solid duplex stainless steel, with the same material used for six cylindrical tanks carried on the upper deck to provide flexibility of cargoes. Transverse bulkhead are corrugated horizontally, with the longitudinal divisions separating the centre and wing tanks flush, and of the sandwich type, forming void cofferdams to reduce heat transfer. All stiffening is arranged outside the tanks, providing a smooth surface for cleaning. Side and bottom double-skin spaces form water ballast tanks, except for the aftermost side pair used for tank cleaning fresh water.

Tank cleaning uses two 200m³/h pumps, arranged for simultaneous operation with sea and fresh water, each medium having its own heater. The **inert gas** arrangements feature a system with nitrogen of 95% purity produced from four 360kW compressors and generators of 3750m³/h capacity, using hollow-fibre air separation techniques. Tanks levels, temperatures and pressures in cargo, ballast and engine room tanks, are measured by a Saab TankRadar installation.

A high-pressure hydraulic system, supplied from five 375kW power packs, operates on a ring main with branches to cargo/ballast tank-cleaning pumps, manifold cranes, bow thrusters and mooring equipment. Cargo and ballast valves, however, are driven from an independent hydraulic system.

The propulsion plant comprises Cegielski Sulzer 6RTA58TB diesel engine, with an output of 12,750kW at 105 rev/min. Three auxiliary diesel gensets drive three 1500kVA generators. They are supplemented by a 1500kVA power take off shaft generator. A rotary vane **steering gear** operates a Schilling Monovec rudder while, manoeuvrability is aided by means of a Kamewa 1000kW **bow thruster**.

Length, oa: 182.88m, Length, bp: 175.25m, Breadth, mld: 32.20m, Draught design/maximum: 10.80/11.50m, Deadweight design/maximum: 36,150/39,842dwt, Gross tonnage: 29,965, Propulsion power: 12,750kW, Service speed at 85% MCR: 15.50 knots.

CHEMICAL TANKERS

Chemical tankers are cargo ships constructed or adapted and used for the carriage of any liquid **chemicals** in bulk. Chemical tankers are required to comply with the various safety aspects detailed in Part B of SOLAS Chapter VIII, but are additionally required to comply with the mandatory **International Bulk Chemical (IBC) Code**.

Chemical cargoes can be very dangerous, most of them being flammable and/or toxic, some of them extremely so. The IBC Code defines three types of chemical tankers: ST1, ST2, and ST3.

- ST1 is a chemical tanker intended to transport most dangerous products, which require maximum preventive measures to preclude an escape of such cargo. Accordingly, a type 1 ship should survive the most severe standard of damage stability and its cargo tanks should be located at the maximum prescribed distance onboard from the shell plating.
- ST2 is a chemical tanker intended to transport products requiring significant preventive measures.
- ST3 is a chemical tanker intended to transport products requiring moderate degree of containment to increase survival capability in a damaged condition.

The IBC Code lists, in its fourteen chapters, the requirements that must be satisfied by a ship prior to it being certified as a chemical tanker regardless of the specific cargoes it is intended to carry. Within each chapter the designer is given an option of the level of compliance

Photo courtesy of STX Europe



required. If compliance with the more onerous requirements is chosen, the ship will be more sophisticated and will therefore be able to carry the more hazardous cargoes.

Chapter 15 of the Code contains 'Special Requirements' which are cargo specific and which must be complied with only if that specific cargo is to be carried. Chapter 16 addresses aspects, which are the responsibility of the operator, whilst Chapter 17 lists all chemicals considered being suitable for transportation by sea. Chapter 17 also summarizes the minimum requirements pertaining to ship arrangements and equipment, which is required to be complied with for the carriage of each chemical, so listed. The list is regularly reviewed and updated by the IMO to ensure that it contains all products regularly transported by sea and that the carriage requirements remain pertinent.

The basic requirements, which must be satisfied prior to the carriage of any cargo listed in the IBC Code, relate to the general arrangement of the ship. As with oil tankers, the accommodation and engine room are required to be situated aft of the cargo tanks. A cofferdam is required at the forward and aft ends of the cargo spaces to further segregate the engine room. Cargoes which, if released into the sea following an accident, would pose a significant hazard to the environment are required to be carried in tanks with no boundary adjacent to the sea – that is, tanks protected by a double skin of hull plating (a longitudinal bulkhead and inner bottom, in addition to the shell plating). Cargoes posing a minimal threat can be carried adjacent to the ship shell plating – that is, either in the centre or wing tanks. The ship must be able to withstand predefined deterministic damages to the hull structure without catastrophic loss of stability, buoyancy or cargo. This 'damage stability' requirement is once again more onerous for those cargoes posing greater hazards.

The major hazards associated with the safe transportation of liquid chemical cargoes in bulk relate to cargo compatibility, toxicity and flammability. The problem of compatibility of each cargo with the materials used in the construction of the ship and its equipment is significant and the list of cargoes in the IBC Code highlights those cargoes which will react with specific materials.

Cargoes, which react in a hazardous manner with one another, are not permitted to be carried in adjacent cargo tanks or to use common ventilation or pumping and piping systems. Cargoes, which are water-reactive, are not permitted to be stowed adjacent to the ship hull or to ballast tanks containing seawater. Heat-sensitive cargoes, which may polymerize, decompose, become unstable or evolve gas, must not be loaded in tanks adjacent to cargoes, which require to be heated to maintain pumpability. Tanks containing heat-sensitive cargoes are required to be fitted with an alarm system, which continuously monitors the cargo temperature.

The risk of cargo spillage during loading, transfer or discharge operations is high. The crew is required to be provided with chemical resistant overalls, boots and gloves. Showers and eyewashers are required to be available on deck so that in the event of an accident involving the crew, water is immediately available.

Antidotes for all cargoes carried must be available on board in accordance with the Medical First Aid Guide produced by the IMO. Many cargoes listed in the Code are toxic and the crew and shore-based personnel involved in cargo operations must be protected from toxic vapors. When carrying toxic cargoes, chemical tankers are required to have additional chemical-resistant suits and self-contained breathing apparatus suitable for use in a toxic environment. All toxic vapours displaced from a cargo tank during loading must be vented directly to shore reception facilities through a vapour return line.

Many cargoes are required by the Code to be carried in a controlled inert atmosphere, either because of their flammability, toxicity or to prevent oxygen from adversely affecting the quality of the cargo. Bottled nitrogen is normally supplied to the ship for this purpose; however, many of the more sophisticated ships have a **nitrogen generating plant** installed on board. Unlike on oil tankers, exhaust gas from the main engines is insufficiently clean for use on chemical tankers, and could impair the cargo quality demanded by the shipper. When carrying cargoes, which evolve highly flammable gases, the Code requires that all electrical equipment installed within their vicinity shall be specifically designed for use in hazardous atmospheres. To assist the designer in the selection of safe electrical equipment, the Code lists the temperature class and apparatus groups, as defined in the International Electrotechnical Commission's Publication '79, for each of the flammable cargoes in the code.

Cargo tank deck foam and firemain systems are required for fighting fires in the cargo tanks or as a result of cargo spillage. The foam compound used must be compatible with the majority of cargoes carried on the ship and an alcohol-resistant foam compound is normally supplied. When cargoes are carried for which foam or water is unsuitable, an alternative fire extinguishing system using a medium such as dry powder must be supplied.

Most modern chemical tankers do not have a dedicated cargo pump room, and normally fit a **deepwell cargo pump** directly into each cargo tank. Each pump has its own dedicated piping system and cargo discharge manifold. The main advantage of this system is that it enables a large number of different cargoes to be discharged or loaded without the need for time-consuming pipe flushing between each cargo. The cargo piping is required to be

Chemicals

constructed of a material compatible with the cargoes carried. To minimise the risk of cargo leakage, all joints – except those to valves or expansion pieces must be welded.

Further reading: *The Outline of Chemical Tankers, ClassNK.*

Chemicals – Substances derived from petroleum or coal, caustics, acids, or products of polymerization.

Cherry picker – Equipment fitted with a hydraulic arm to enable inspectors and workers to approach inaccessible areas of a structure.

Chief Engineer – The senior engineer officer responsible for the satisfactory operation and maintenance of the main and auxiliary machinery and boiler plant on board ships. He keeps records of all engine parts and repairs, calculates fuel and water consumption and requirements. Co-ordinates operations with shoreside port engineer.

Chief Mate, Chief Officer – The officer in the deck department next in rank to the Master. The chief mate takes over the position of the Master in his absence.

Chine – A sharp edged bend in a ship hull plating.

Chlorinated rubber – High molecular weight polymer which is used as a binder in some physically drying paints.

Chock – A guide for a mooring line, or steel towing wire which enables the line to pass through a ship **bulwark** or other barrier. See also **Fairlead**, and **Arrangement of chocks and bitts for transit of Panama Canal**.

Double chock – A large chock capable of withstanding the stress caused by a load of two towing wires. According to requirements of the Panama Canal the double chock is a closed chock that has a throat opening of not less than 900 cm² area, and is capable of withstanding the stress caused by a load of 64,000kg from the towing wires in any direction.



Photos: J. Babicz

Chocks can be bulwark- or deck mounted

Single chock – Chock designed for a single towing wire. According to the requirements of the Panama Canal the single chock is a closed chock that has a throat opening of not less than 650 cm² area, and is capable of withstanding the stress caused by a load of 45,360kg from a towing wire in any direction.

Chocks – One of several pieces of metal precisely fitted between machinery units and their foundations to ensure alignment, also made by pouring plastic material in place (cast resin chocks).

Christmas tree –

1. A set of Suez Canal lights on the rear mast. They look as lights on the Christmas tree.
2. An assembly of valves and fittings that is installed on the **wellhead** to control the flow of high-pressure oil and gas.

CIF – Cost, Insurance, Freight. CIF designates the cargo is to be carried free of charge for the buyer; the seller pays all transportation costs.

Circuit – A combination of electrical devices and conductors which, when connected together in a closed path, perform a particular function.

Circuit breakers – Devices that interrupt high currents to protect electrical equipment from damage caused by current surges, e.g., from a short circuit or a lightning strike.

Circuit diagram – A drawing which details the functioning of a **circuit**. All the essential parts and their connections are shown by special symbols.

Circulating pump – A centrifugal or axial-flow type pump which supplies large volumes of water to a system, usually for cooling purposes, e.g. jacket water circulating pump, seawater circulating pump.

Cladding – A coating applied to a material, e.g. a stainless steel coating bonded onto mild steel.

Clamp truck – A small electric track used onboard to handle paper reels and powered by electric cable from the ship supply.

Clarification – Liquid/solids separation with the intention of separating solid particles from a liquid having a lower density than the particles.

Clarifier – A separator that cleans the oil from solid particles and traces of water.

Clarifier disc – A disc which replaces the gravity disc in the separator bowl in the case of clarifier operation. The disc seals the water outlet in the bowl, thus no liquid seal exists.

Class – Classification symbols and associated marks and notations assigned to a vessel by a **classification society** depending on the design of the vessel, the quality of materials employed, the scantlings of the various structural members, and the outfit and equipment, all of which should be up to the standard specified by the society rules. Each classification society has its own way of recording the constructional details of a ship, which are finally entered on the certificate of class and in the Register book. The validity of the assigned class is conditioned upon due to compliance with the requirements regarding **maintenance of class**.

Class notation – The classification details of a ship hull or machinery using particular terms or abbreviations, e.g. oil tanker, UMS (unattended machinery space).

Class surveyor – Any member of the technical staff of the classification society. The primary task of classification society surveyors is to survey in order to maintain the standards of construction and condition of ships and machinery, which have been laid down by the society. The secondary function of class surveyors, where their society is approved by governments, is for their surveys to be used as a basis for the issue of **statutory certificates** relating to safety at sea. Surveyors who are full time employees are generally referred to as “Exclusive” surveyors; the ones employed on a part time basis are “Non-exclusive” surveyors.

Class term – **Classification certificates** are issued for a period known as the class term or the term. The first term starts from the date of the initial classification survey. A new term is assigned to the ship after satisfactory completion of the **special survey** and new classification certificates are issued.

Classification

To assess the seaworthiness of a ship in service, periodical inspections are carried out, and their findings are compared with the requirements of Rules for ships in service. If conformity to Rules is noted, the certificate is renewed for a certain period of time.

Classification – The assigning of **class** to merchant ships according to certain rules established by a **classification society**. The classification of the ship helps the owner, in the event of a casualty, to establish that he had used “due diligence” required of him; informs the shipper that he is not taking a disproportionate risk by sending his goods aboard that particular ship; and it helps the **underwriters** decide about the nature of the risk involved when he is asked to insure the ship.

Classification certificates – Certificates for hull, machinery installations, boilers, automated installations, etc, issued by a classification society to confirm the class of the ship. These certificates are generally a requirement before **underwriters** insure the vessels.

Classification process – The process of class assignment starts with the application made by the owner or the builder. The documents relevant to the class applied for are submitted for the review of the society. Materials and equipment are inspected at works. During construction of the ship **class surveyors** carry out inspections to check that construction is in accordance with approved drawings, that the ship is built to accepted standards, and supervise tests and trials provided for. After completion of the surveys, the class surveyor issues interim **classification certificates** to the party applying for the classification and prepares a report for the society. After satisfactory review of the report, the society issues the definitive classification certificates and the class assigned to the ship is confirmed in the register.

Classification societies – Usually non-profit organizations originally introduced to protect the interests of shipowners and cargo owners and their insurers to ensure that the ship and its cargo will safely reach their destination. Among the most important are Lloyd’s Register of Shipping, Det norske Veritas, the American Bureau of Shipping, Bureau Veritas, Germanischer Lloyd, Registro Italiano Navale and Nippon Kaiji Kyokai.

See also **International Association of Classification Societies**.

The origins of the classification society date back to the middle of the 18th century. World trade was the almost entirely dependent on shipping. The technology available was very basic, and there were no controls on the condition of merchant ships – many of which were in poor condition and frequently overloaded. As a result of the high number of losses of ships and cargoes, many of those financing the shipping business, particularly the insurers, agreed that there was a need to establish objective safety criteria and regular inspections to reduce the frequency of shipwrecks.

Clear view screen – A device which offers a clear area in a **bridge** or **wheelhouse** window in foul weather. It consists of a glass disc supported on its centre by a bearing and actuated by an electric motor. The motor operates at such a speed that the rotating glass disk throws off rain, spray, snow, and gives clear visibility under any weather condition.

Cleading – A covering used to prevent the radiation or conduction of heat, e.g. boiler casing.

Clearance of vessel – A vessel has clearance when official permission is given by the authorities to leave port.

Cleat –

1. A fitting having two arms or horns around which ropes may be made fastened.
2. A resilient bolt arrangement intended to restrain the hatch cover vertically.

Wedge cleat – A cleat which relies on a wedging action rather than behaving as a bolt in tension.

Clench pin – A pin that secures the final link of the **anchor chain** to the ship structure within the **chain locker**. Removal of this pin enables an emergency release of the **anchor** and chain.

Climate research vessel MARIA S. MERIAN with podded propulsion drives

One of the world's most advanced oceanic **research ships** was christened the "MARIA S. MERIAN" on 26 July 2005, honoring the German woman who is recognized as the world's first entomologist. The ship is poised to play a prominent role in oceanic research and allow scientists to document the physical realities of climate change while investigating the current health of the world's oceans. Its geographic scope will reach from the Arctic Circle to the northernmost reaches of the Gulf Stream. Equipment aboard the ship can create images of the ocean floor up to 10,000 meters deep.

Although the order was placed with Kroeger Werft, the building of the ship was contracted out to Polish shipyards: Maritim Ltd in Gdańsk and Naval Shipyard in Gdynia.

The ship is powered by a **diesel-electric propulsion** system comprising two 1600kW 8L21/31 and two 1200kW 6L21/31 diesel gensets, two 2050kW Schottel Electric Propulsors as well as a 1600kW Schottel Pump Jet type SPJ320 as a manoeuvring aid.

The L21/31 engines are the first in the world to have been delivered in compliance with the 'Blue Angel' emission standard. The engines were specially adapted to low **NOx emission** levels (without any fuel penalty) by optimising the primary process internally in the engine and without any after-treatment of the exhaust gas.

The pods drive the vessel at a maximum speed of 18 knots and a service/cruising speed of 15 knots.

A number of novel features are incorporated, among these are seven special winches supplied by Hatlapa. One speciality is the combination of friction and storage winch for handling the very long and relatively thin measuring cables. The advantage is that the sensitive and expensive research ropes can be spooled on the storage winch free from load. The pull is created in the friction part and exerted via several grooved drums to protect the rope. A spooling device also guarantees the rope to be wound onto the storage winch in a clean and gentle manner. Thereby the crossing of rope layers resulting in rope breakages are avoided. The storage winches have a very large drum diameter for realising low bending radii of rope for protecting the sensitive measuring wires in the ropes.

The ropes are not just normal synthetic or steel wire rope, but consist of a single cable with an outer coating of synthetic material to protect the conductor against damage, to guarantee the necessary shielding, and to absorb the forces.

Constant communication between the control and measuring instruments is possible by transmission rings in the winch, also during paying-out and hauling-in the rope. Furthermore, lighting conductor cables are in use which have a similar structure, allowing also constant communication between the control and measuring instruments.

By using frequency inverter controlled motors, the speed can be infinitely controlled and the winches operated synchronously. The otherwise usual maximum demands on the shipboard power supply, the ropes and mechanics are eliminated, because the winches are on stand-by from zero speed to full torque, thus allowing a smooth start. The electric driving capacity of each winch is up to 352kW, which is produced by 4 motors of each 88kW. By using 4 motors, capacity reserves are increased on the one hand, and on the other hand, the distribution of the load into the gear allows a compact construction. To dissipate the heat arising in the electric motors, water-cooling has been provided.

RESEARCH VESSEL MARIA S. MERIAN

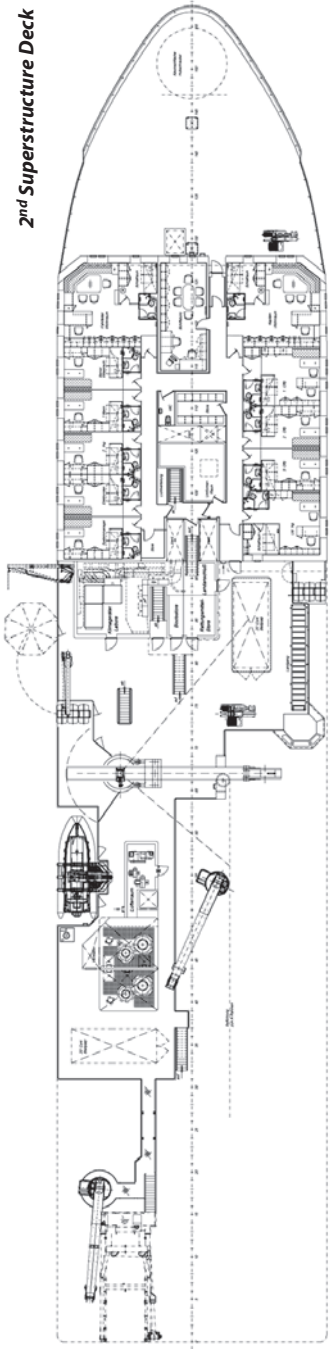
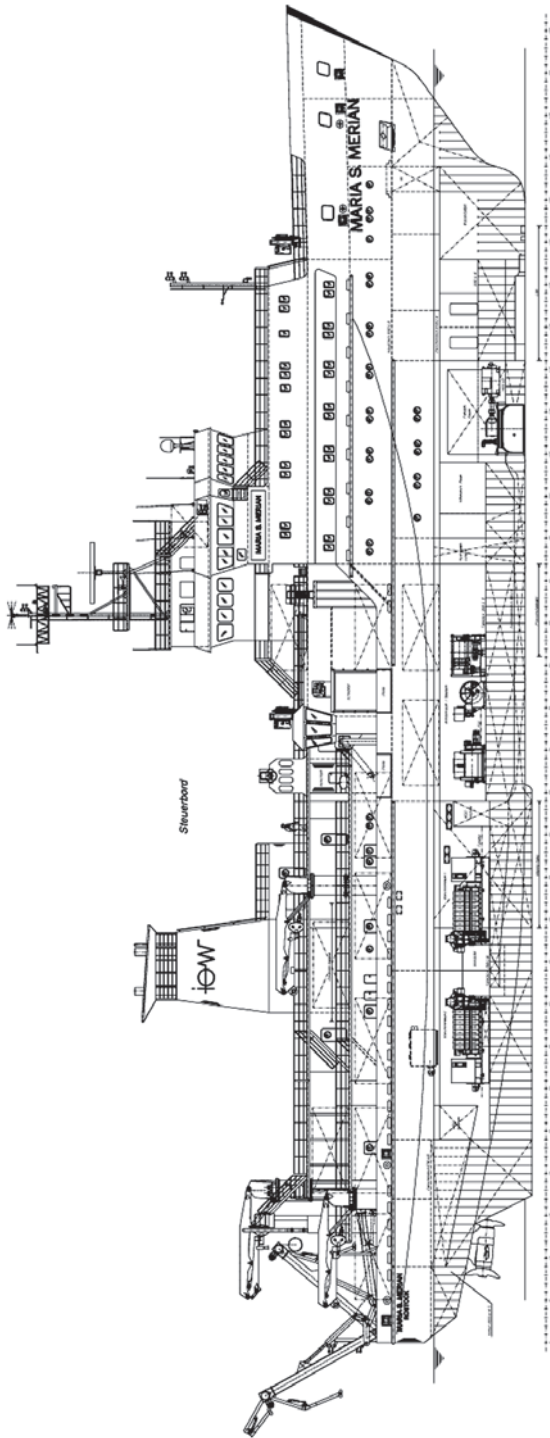

1st Superstructure Deck

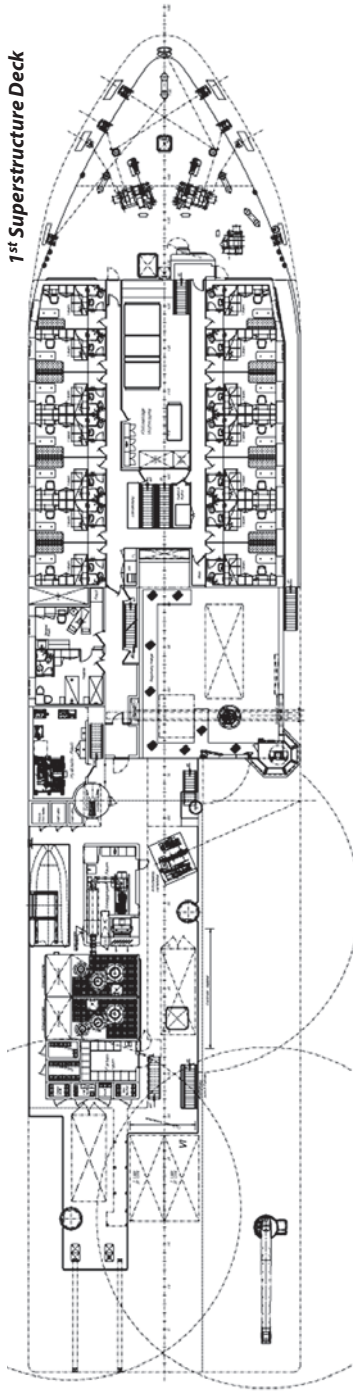

Main Deck

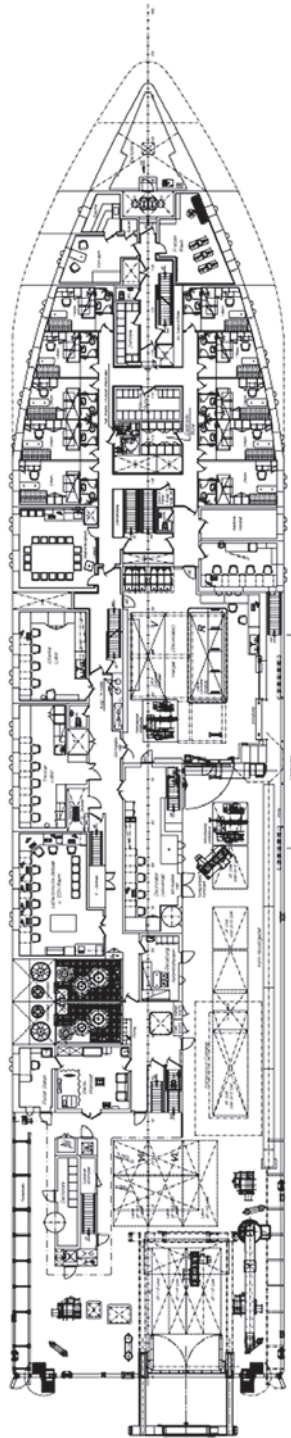

Tween Deck

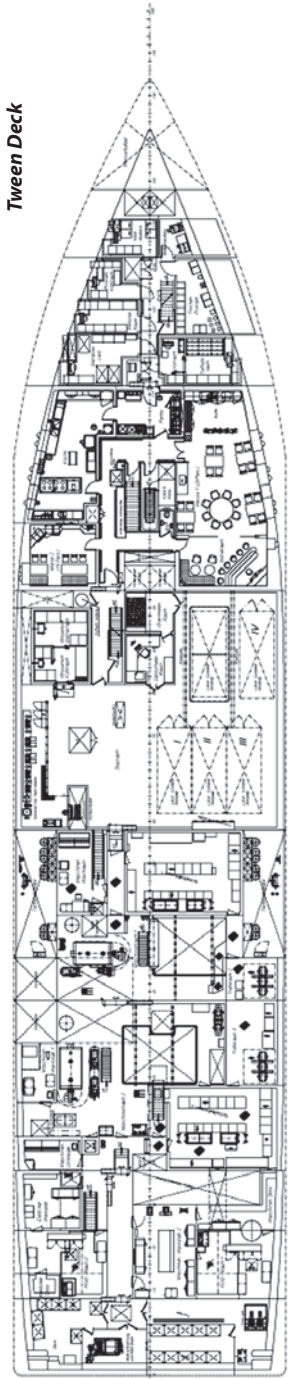

Double Bottom

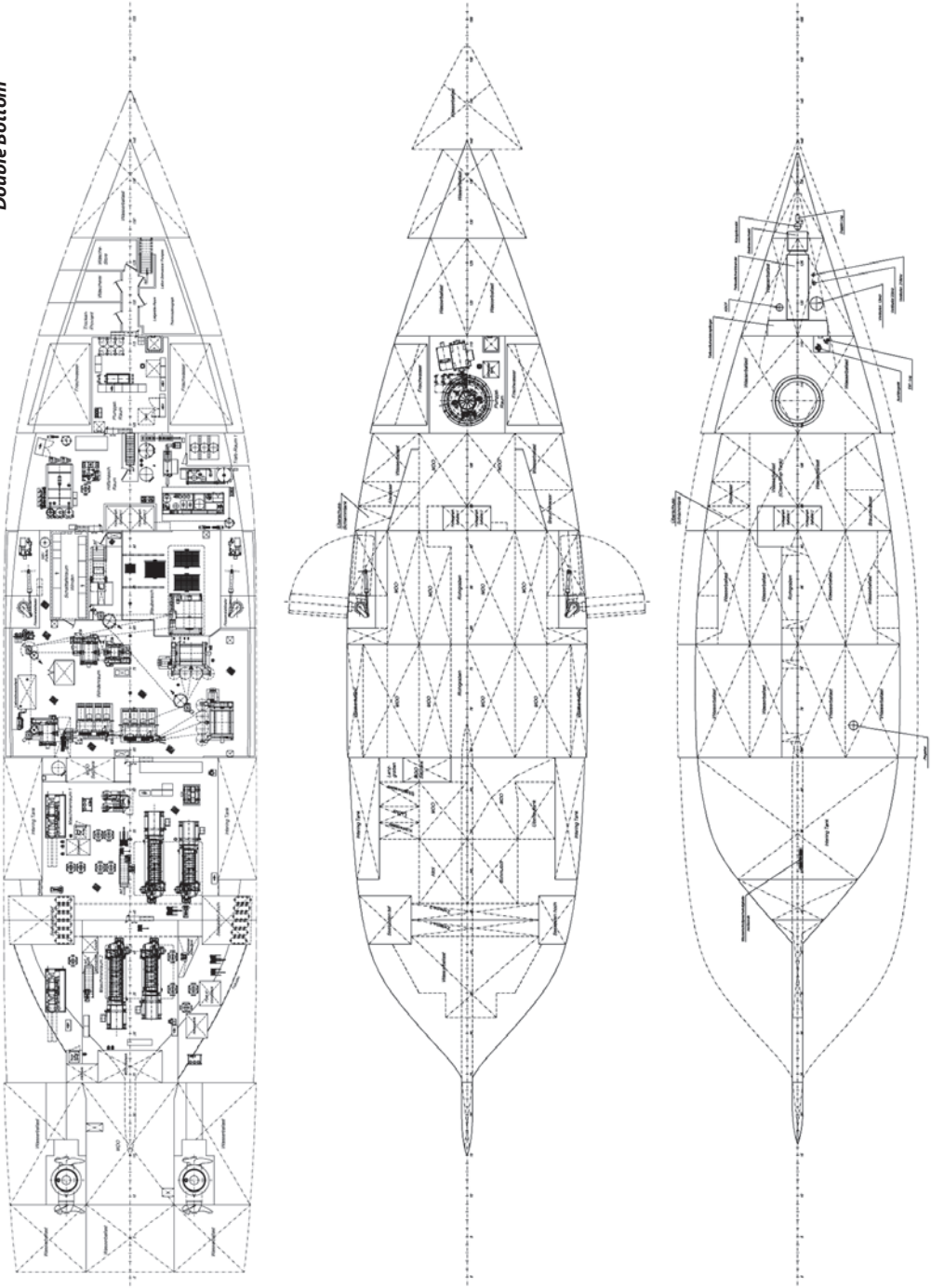

Length (oa): 94.8m, Breadth: 19.2m, Draught (max): 6.5m, Speed: 15 kn, Class: GL + 100 A5 E3 Nav-OC (special vessel) + MC E3 AUT RP3 50% strengthened to Polar Class PC 7

Clingage – Oil remaining on pipe walls or on the internal surfaces of tanks after the bulk of the oil has been removed.

Clogging indicator – A display unit fitted to a filter to indicate the condition or degree of cleanliness.

Closed drains – Hard-piped drains from process components, such as pressure vessels, piping, liquid relief valves, etc., to a closed drain tank without any break to atmosphere, (ABS).

Closed Overflow System – A system constructed and equipped so that during fuel oil bunkering the allowable design pressure of the storage tanks cannot be exceeded. A closed overflow system consists of all pipelines, storage tanks and overflow tanks together with their valves and fittings as well as control and measuring devices.

Closed vehicle spaces – Vehicle spaces, which are neither open vehicle spaces nor weather decks, (SOLAS).

Closest point of approach (CPA) – The shortest target vessel – own vessel calculated distance that will occur in case of no change in course and speed data.

Close-up survey – A survey where the details of structural components are within the close visual inspection range of the **surveyor** i.e. preferably within reach of hand.

Closing appliance – Any cover or other item functioning as a cover for an opening in the shell, deck or bulkhead.

Cloud point – A temperature at which waxes will form in the fuel, pipe or filter blocking may occur.

Clutch – A device to connect, or disconnect a driving unit to the unit it drives.

CNG (Compressed Natural Gas) carrier – New concept of fully-pressurized gas carrier fitted with steel pipes used as pressure vessels. Different from the **LNG tanker** that maintains LNG in liquefied form at -163°C at near atmospheric pressure, the CNG carrier will transport the cargo in a gaseous state at temperature down to -29°C , and at pressure from 130 bar to 250 bar, depending on the precise design.

Further reading: *ABS Guide for “Vessels Intended to Carry Compressed Natural Gas in Bulk” (2005), can be downloaded from www.eagle.org*

DNV developed throughout 2002 rules for CGN carriers that were issued in January 2003 and came into force July 1st 2003. The DNV CNG rules set strict requirements for the protection of the cargo tanks from damages due to collision and/or grounding. Without compromising on safety, the use of DNV submarine pipeline standard reduces the steel weight of the cylinders to 50% of what should have been necessary with the requirements of the International Gas Code. It has been shown that the probability of burst is less than 10^{-6} per year and the probability of fatigue failure is less than 10^{-5} per year for a typical CNG carrier with up to 3900 pipes of total length of 150km.

CNG concept – The cost of liquefaction and associated facilities makes the exploitation of smaller reserves a costly affair. The Compressed Natural Gas (CNG) concept is cost-effective solution for transporting natural gas from the production site to the consumers. The key of this concept is specially-equipped ship with pressurised containment systems to transport gas under high pressure; see **Coselle CNG System**. **CNG carrier** does not require a gas liquefaction plant or LNG storage tanks.

CO₂ extinguishing system – see **Carbon dioxide (CO₂) flooding system**.

CO₂ room – A fully-separated space designed and equipped for the storage of CO₂ cylinders. CO₂ room shall be located aft off the collision bulkhead. As far as possible, the CO₂ room should be located on the open deck. If such arrangement is not possible, the room can be located one deck below the open deck and shall have a stairway or ladder leading directly to the open deck. Access doors must open outwards.

CO₂ welding – A non-standard term for **gas metal arc welding** with carbon dioxide shielding gas.

Coal – Coal stows at 1.2-1.4 m³/t. It is handled with conveyors and grabs.

Coal tar epoxy – A combination of epoxy resins and tar, which if applied to paints gives a water resistant film. A curing agent must be added if **curing** is to take place.

Coal tar pitch – A brittle, lustrous bituminous coal, also known as bituminous lignite.

Coalescence – The process of combining of small oil droplets into drops which will separate under gravity. A coalescent filter is used downstream of an oily water separator to improve separation down to a few particles per million.

Coalescer – A device containing a material with the surface promoting **coalescence**.

Coaming – A protrusion formed around an opening. Its purpose is to prevent water from running into an opening or to compensate for the strength loss due to cutting the opening in the plating.

Hatch coaming – The vertical plated structure built around a hatchway to prevent water from entering the hold, and to serve as a framework for the hatch covers.

Coaming top water channel – The peripheral drain for any water which may ingress through the seal.

Coastal waters – Navigation area along the coast where freedom of course-setting to one side of the course line may be restricted, the other side of the course line, however, allows freedom of course-setting in any direction for a distance equivalent to at least 30 minutes of sailing at the relevant ship speed.

Coastal tanker ASPERITY

According to **The Motor Ship** June 1997

The double-hulled coastal tanker ASPERITY was built by Singmarine Dockyard and Engineering, Singapore. A major feature of the **cargo tank** arrangement is the elimination of the centreline **bulkhead** to reduce discharge time to halve the number of tanks to pump. In the result, the ship has five cargo tanks of varying size, which allow small parcels of differing product grades to be transported. Each cargo tank is equipped with the Wärtsilä Svanehoej variable speed **deepwell pump** with a capacity of 550 m³/h at 90m liquid column. Loher 174 kW explosion proof motors are sited on the trunk top and drive the pumps using Cardan shaft.

All cargo lines and tank fittings are made of stainless steel. Cargo valves are stainless steel high-performance butterfly valves. Cargo **stripping** and tank washing valves are stainless steel ball valves.

The cargo control system comprises a loading computer, **tankradar** and temperatures probes, ballast, bunker, fresh-water and draught **gauging** and an independent hi-hi tank alarm system.

Two computer monitors with light pens control the five deepwell cargo pumps, the slop pump and ballast pumps. Other details monitored are cargo tank ullages and pressures, slop tank **ullage** and pressure, tank temperatures. The control system has mimic diagrams

and monitors the control plan and two-valve segregation parameter. Dynamic colouring of pipelines indicates flow and the opening of valves. Continuous information of tank levels is provided to the Kockumation loading computer for a continuous update of tank status and ship **stability**.

A main engine develops 2000kW at 825 rev/min. It drives a 3.3m diameter CP propeller at 160 rev/min through a gearbox. An arrangement of clutches allows the shaft alternator to be used as the emergency propulsion, providing a “get-you-home” speed of 9 knots.

Length, oa: 88.76m, Length, bp: 82.20m, Breadth, moulded 16.50m, Depth, moulded: 7.65m, Draught: 5.60m, Displacement: 5490t, Lightweight: 1712t, Deadweight: 3778dwt, Service speed: 12.5 knots, Cargo capacity: 4266m³.

Coaster – Usually a small multi-purpose **cargo ship** used for short sea transport. Low-air-draught is often required in order to pass overhead obstacles on inland waters, such as bridges.

Coastguard vessel – A ship that can monitor, patrol and protect coastal waters and also can carry out pollution control, salvage and firefighting tasks. With world resources in decline and international law allowing Exclusive Economic Zones out to 200 nautical miles there is increasing interest in such type vessels.

Coastguard vessel K/V TURVA

Built in 2014 at STX Rauma Shipyard the coastguard vessel TURVA is 95.9m long and 17.4m wide, making her the largest vessel ever commissioned by the Finnish Border Guard. Fully laden, she draws 5m of water. At design draught, the vessel has a deadweight of 660t while her maximum deadweight is around 1800t. Her complement will be approximately 30.

The main purposes of the new offshore patrol vessel are open sea patrol and ensuring border safety. TURVA carries a rigid-hulled inflatable boat and a larger patrol boat, both stowed in covered recesses, that can be used to carry a vessel inspection teams to intercepted ships. While the vessel does not have a hangar, the forward helipad with folding “wings” is large enough for receiving and refueling a Eurocopter AS332 Super Puma, the largest type of helicopter operated by the Finnish Border Guard, during search-and-rescue operations at sea. TURVA is the first Finnish patrol vessel fitted with such capability. For surveillance, TURVA has a Cassidian TRS-3D radar and extensive command and control systems which allow the ship to direct large rescue operations both in the air and on the surface. The vessel is also fitted with underwater surveillance systems.

TURVA is also equipped for rescue operations, firefighting, emergency towing and demanding environmental duties. She can perform mechanical recovery of spilled oil with built-in recovery systems in open water, either by using conventional outriggers and booms in calm seas or a stiff steel boom and a special wave-dampening channel in heavy weather. The oil recovery system has been manufactured by the Finnish company Mobimar which has also provided equipment for other Finnish patrol vessels. Furthermore, the vessel is also fitted for but not with equipment capable of recovering oil in ice conditions. The internal storage tanks are dimensioned for 1000m³ of recovered oil and 200m³ of recovered chemicals. The 350m² open aft deck is covered with tropical hardwood, Iroko. For diving support and oil recovery tasks, TURVA carries a small **workboat**.

TURVA is powered by three environmentally friendly Wärtsilä 34DF series dual-fuel engines capable of burning both diesel fuel as well as **liquefied natural gas** (LNG). For **redundancy**

COAST GUARD VESSELS

Photos courtesy of Aker Yards ASA



K/V HARSTAD



K/V SVALBARD

and **safe return to port**, the engines are arranged in two independent engine rooms divided by a **watertight bulkhead**. In the aft engine room, a 12-cylinder Wärtsilä 12V34DF producing 6400kW is mechanically coupled to a controllable pitch **propeller**. In the forward engine room, two 6L34DF generating sets with an output of 3000kW each produce power for two electrically-driven **Azipull AZP120CP thrusters**. If the forward engine room is damaged, the shaft generator coupled to the bigger engine can be used to produce electricity for the azimuth thrusters, which are required for steering the vessel as she has no separate rudders, and other onboard systems. Since the azimuth thrusters are powered by electric motors and the centerline shaft is mechanically coupled to the main engine, the propulsion system as a whole could be referred to as “combined diesel-electric and diesel” (CODLAD). TURVA is the first ship fitted with this type of propulsion arrangement – two azimuth thrusters and a centerline shaft – which was originally developed for icebreakers and icegoing LNG carriers. For maneuvering and DP2 class **dynamic positioning**, the ship has a transverse bow thruster and a retractable azimuth thruster in the bow.

TURVA is the first LNG-powered offshore patrol vessel as well as only the second LNG-powered ship (after VIKING GRACE) to enter service in Finland. Unlike in the ferry, which has two deck-mounted LNG storage tanks, the single fuel tank in TURVA is built inside the vessel.

The service speed of the vessel will be 18 knots and despite her bulbous bow she will also be capable of breaking level ice up to 0.80m in thickness. With a **bollard pull** of approximately 100t, TURVA is capable of towing even the largest tankers regularly sailing in the Baltic Sea.

Coat – The paint applied to a surface in a single application to form a properly distributed film when dry. Each paint layer of a paint system.

Coating, painting – Protective film of thickness usually about 0.2-0.5mm, applied on steel surfaces to protect them from corrosion.

Antifouling coating – A coating aimed at preventing damage to the exposed surface by the adherence and corrosive action of living microorganisms.

Anticorrosive coating – A coating with the primary purpose to prevent the corrosion of an exposed surface.

Hard coating – A coating, which chemically converts during its curing process, normally used for new construction, or non-convertible air-drying coating which may be used for maintenance purposes. Hard coating can be either organic or inorganic and covers typical marine coatings such as those based on epoxy, coal tar epoxy, polyurethane, chlorinated rubber, vinyl, zinc epoxy, zinc silicate.

Coating conditions:

GOOD – The condition with only minor spot rusting as defined in resolution A.744(18).

FAIR – A term used to describe the condition of a hard coating; with local breakdown at edges of stiffeners and weld connections and/or light rusting over 20% or more of areas under consideration, but less than as defined for POOR condition.

Coating evaluation criteria – An assessment of the extent of damage registered in terms of coating breakdown area and/or rust scales in % of area under consideration, normally the complete tank, with additional information on coating damage to edges and weld connection.

Coating specification

Coating specification – The specification of coating systems which includes the type of coating system, steel preparation, surface preparation, surface cleanliness, environmental conditions, application procedure, acceptance criteria and inspection.

Further reading: *IMO Resolution MSC.(215)82*

Cock – A valve arrangement where the liquid flows through a hole in a central plug.

CODAG – see **Combined diesel- electric and gas turbine propulsion system.**

CODAG propulsion system of CORAL PRINCESS

The CORAL PRINCESS built in 2002 at Chantier de l'Atlantique is P&O first CODAG cruise liner. This machinery and propulsion system brings together a General Electric 25,000kW gas turbine located in the funnel and driving an alternator and two 16,200kW diesel-alternators fitted in the main machinery room and using Wärtsilä prime movers.



The three alternators supply power to two main switchboards and twin 20,000kW Alstom variable speed propulsion motors. These drive FP propellers in an arrangement, which provides 50% redundancy in case of fault, with back-up electrical supply available from two 1080kW diesel-alternators sets.

Code of Container Position – Position of container on board a ship is defined by three numbers: bay number, row number and tier number.

Code of Safe Practice for Solid Bulk Cargo (BC Code) – The Code first adopted by **IMO** in 1965 and updated regularly since then by the Subcommittee on Containers & Cargoes. Since 1991, the BC Code has been included in Chapter VI of the 1974 SOLAS Convention. This Code highlights dangers associated with the shipment of certain types of bulk cargoes, gives guidance on various procedures which should be adopted, lists products more frequently shipped in bulk, provides information on their properties and the way how they should be handled, and describes several methods to be used to determine characteristic properties of cargoes.

CODED – see **Combined diesel-electric and diesel-mechanical propulsion.**

Coefficient – A factor used as a multiplier of the quantity or variable, being considered.

Coefficients of form – Coefficients used in naval architecture: block coefficient, midship section coefficient, prismatic coefficient and waterplane coefficient.

Block coefficient – The ratio of the underwater volume of a ship to the volume of a rectangular block, the dimensions of which are the length between perpendiculars, the mean draught and the breadth extreme. The relationship is expressed as a decimal figure. $C_b = V/LppBT$ where V is the **volume of displacement**, in m³, at draught T.

Coefficient of fineness of a waterplane – The ratio between the area of the waterplane and that of a rectangle of the same length and breadth. The average value of this coefficient for merchant ships is usually between 0.75 and 0.8.

Longitudinal prismatic coefficient – The ratio of the **volume of displacement** to the volume of a prism with the length equal to the length between perpendiculars and a cross-section area equal to the midship section area.

Midship section coefficient, also coefficient of fineness of the midship section – The ratio between the actual underwater area of a midship section and that of a rectangle of the same depth and width. The average value of this coefficient is 0.9 for merchant ships.

Cofferdam – An isolating space arranged so that compartments on each side have no common boundary; a cofferdam may be located vertically or horizontally. A cofferdam on tankers may be a void space or a ballast space.

COGES – see **Combined gas turbine and steam turbine integrated electric drive system**.

COGES propulsion system of the MILLENNIUM cruise liner

The cruise liner MILLENNIUM built by Chantier l'Atlantique for Royal Caribbean/Celebrity Cruises has pioneering machinery installation. For the first time in merchant ships for some 25 years, gas turbines are used for the primary power. In addition, the ship features the first shipboard use of **Mermaid** podded propulsors. The power plant arrangement is based on the use of two General Electric gas turbines driving Brush alternators each delivering 25MW. These are supplemented by the output from a Fincantieri turbine which draws steam from a waste-heat boiler fitted in the exhaust lines from the gas turbines, to drive 9MW alternator.

59MW of electrical power generated in this way, 39MW is available for propulsion, with the rest satisfying all other shipboard needs. The MILLENNIUM is powered by Mermaid units developed by Alstom and Kamewa, which have the unique facility of shaft seals and the entire pod replaced while the ship is afloat.

Many "green" benefits are claimed from this novel propulsion concept, with NO_x emissions reduced by 80%, and the use of higher quality fuel reducing SO_x quantities by 98%. The internal space saved resulted in an addition 40 passenger and 20 crew cabins available. Reduced noise and vibration allows 26 cabins with aft-facing verandas to be built over the stern.

Coil decks, cradle tweendecks – Purpose-built panels developed and patented by the Finish ship owner Lanh Ship in order to accommodate steel coils on a general cargo ship. Each panel incorporates special V-shaped grooves which can secure coils ranging in diameter from 1,200mm to 2,200mm. The maximum coil load for each panel is 350 tonnes, stowed in five 70-tonne grooves. These panels are situated as high as practicable in the holds. This reduces the vessel's metacentric height and increases the rolling period, improving the seakeeping of the vessel when carrying steel coils.

Cold ironing

Cold ironing – Connecting ships to the onshore power supply and shutt down the gensets in order to decrease exhaust emissions and noise. Cold ironing was adopted for many decades in naval bases where ships may be docked for long periods.

For more information visit www.cavotec.com

Cold ironing for commercial vessels was launched in Los Angeles in 2004 when China Shipping's container ships were plugged into a dedicated port barge floating close to the berth. The barge housed all the necessary equipment for the shore connection, including the high voltage and low voltage cable management system, transformer and switchgear. A more sophisticated shoreside power programme was initiated the next year with the Japanese operator NYK, which commissioned the first ship with an integrated onboard electrical system to facilitate cold ironing. NYK ATLAS was the first vessel able to plug directly into the wharf without using a barge link. Emissions saving from the ship are said to amount to 31 tonnes of NOx and 1.4 tonnes of particulate matter.



The fixed shore-based power supply

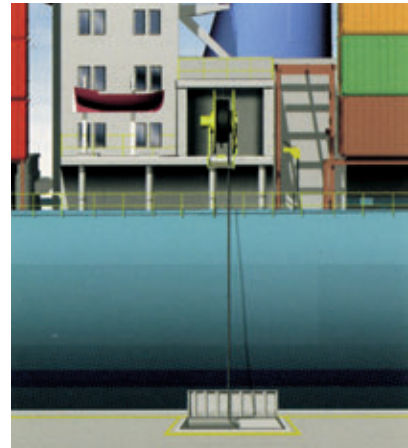

The fixed "On ship" system provides a direct connection from the ship to an integrated electrical pit

Cold storage – The preserving of perishable foodstuffs by storage in a refrigerated space at an appropriate temperature.

Cold work – Any work which cannot create a source of ignition.

Collapsible mast – A mast hinged near the deck so it can lie horizontally.

Collar, collar plate – A welded plate used to, partly or completely, close a hole cut for a longitudinal stiffener passing through a transverse web.

Collision – The act of ships striking each other.

Collision damage – Damage caused by physical contact between two or more ships.

Collision Regulations (COLREG 1972) – The Convention on International Regulations for Preventing Collision at Sea adopted in 1972 by **IMO**.

Combined cycle technology – The use of two different power generation processes, e.g fuel engines and steam turbines, in the same power plant. The second process utilizes the heat recovered from the first.

Combined diesel-electric and diesel-mechanical (CODED) propulsion – A novel propulsion and machinery concept developed by Wärtsilä Corporation. The concept features a diesel-mechanical part driving a conventional propeller and a diesel-electric power plant powering one or more electric pods.

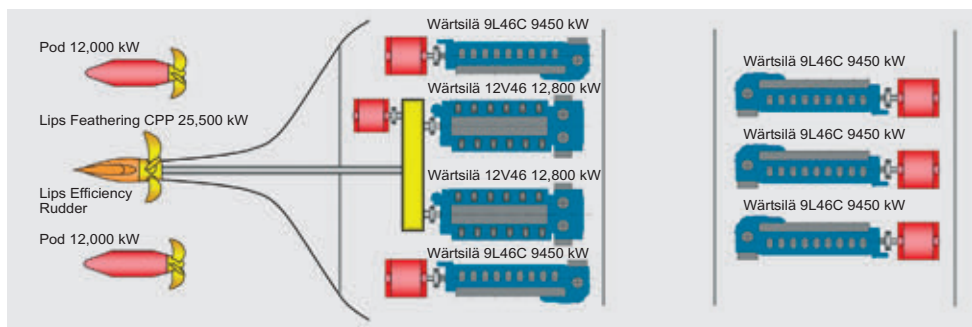

Wärtsilä has proposed to adopt the CODED machinery consisting of two azimuthing pods and one mechanically driven feathering CP propeller for the next generation of cruise ships. This arrangement offers very high propulsion efficiency. The possibility to split the load between three propellers instead of two yields better propeller open water efficiency. Furthermore, the single-skeg hull form without any open shaft lines has lower resistance than a twin shaft line arrangement. At low speeds, the vessel is driven by the pods alone. The centerline propeller is only used at high speeds and feathered at low and medium speeds. The feathered mode (pitch changed to align the blades with water flow) results in significantly less resistance than for a windmilling propeller.

Other version of CODED machinery with one **pod** installed in a contra-rotating mode aft of the main propeller has been proposed for **RoPax** vessels. This configuration offers better hydrodynamic efficiency, compared with twin screws on long open shafts supported by brackets. The aft propeller takes advantage of the rotative energy left in the slipstream of the forward propeller improving the rotative efficiency. In addition, the resistance of the single skeg hull form with a single pod is lower than of a twin-screw hull with two open shaft lines, two rudders and many appendages. Such configuration has been used for ferries **AKASHIA** and **HAMANASU**; see **CRP-Azipod propulsion of the ferries AKASHIA and HAMANASU**.

Combined diesel-electric and gas turbine (CODAG) propulsion

Combined diesel-electric and gas turbine (CODAG) propulsion – A hybrid machinery system with a gas turbine and diesel engines driving generators to create electric power for both propulsion and the hotel side. See also **CODAG propulsion system of CORAL PRINCESS**.



QUEEN MARY 2

The vessel is driven by four Mermaid pods. The 117,200kW CODAG installation is supplied from four 16,800kW Wärtsilä/ABB diesel alternator sets, supplemented by the output from two alternators with 25,000kW General Electric gas turbine drive. The diesel installation produces some 57% of power requirements, with 43% derived from the gas turbine sets.

Combined gas turbine and steam turbine integrated electric drive system (COGES) – In a COGES system gensets are driven by gas and steam turbines. Waste heat recovery boilers exploit the gas turbine exhaust and produce superheated steam (at around 30 bar) for the steam turbine genset. While gas turbine efficiency decreases at low load the steam turbine recovers the lost power and feeds it back into the system. The result is a fairly constant fuel consumption curve over a wide operating range. See also **COGES propulsion system of the MILLENNIUM cruise liner**.

Combination carrier – A general term applied to ships intended for carriage of both **oil** and dry cargoes in bulk. These cargoes are not carried simultaneously, except for oil retained in slop tanks. The design of a combination carrier is similar to a conventional bulk carrier but such a ship is equipped with pipelines, pumps and **inert gas** plant. See also **Tri-Cargo Carrier**.

Oil/Bulk/Ore (OBO) carrier – A single-deck ship of double skin construction, with a double bottom, hopper side tanks and topside tanks fitted below the upper deck and intended for the carriage of **oil** or dry cargoes, including ore, in bulk.

OBO carrier SKS SKANA can carry three grades of cargo in seven tanks, all of which are coated with tar epoxy, and fitted with a deepwell pump. These are supplied from power packs driven by individual diesel engines.

Ore/Oil carrier – A single-deck ship having two longitudinal bulkheads and a double bottom throughout the cargo region and intended for carriage of ore cargoes in the centre holds or oil cargoes in the centre holds and wing tanks.

Combined product/LPG carrier STENA CARIBBEAN

According to **The Motor Ship** December 2002



This wide-beam/shallow-draught vessel was designed for operation in the very sensitive waters of the Caribbean archipelago, loading and unloading in restricted waters, even direct to beaches using floating hose pipes. Meeting the stringent environmental requirements has heavily influenced the design. In addition to a double-hull configuration, the ship has been fitted with a pair of azimuthing **thrusters** which, together with the 650kW bow thruster, provides an exceptionally high degree of **manoeuvrability** enabling the vessel to turn within her own length.

STENA CARIBBEAN is the first vessel built for Stena that incorporates a diesel-electric propulsion system and azimuthing thrusters. The prime movers consist of two Wärtsilä medium-speed 6R32LND diesel engines, each with an output of 2220kW at 720 rpm. They drive two Siemens generators capable of producing 2500kVA each.

Auxiliary generators consist of two Wärtsilä 4L20C diesels with a 630kW output at 900rpm and each coupled to a 750kVA Siemens generator. An emergency backup power supply is provided by a high-speed MAN D2688TE diesel providing a power supply of 200kW at 1800rpm and generating 200kVA through a Stamford generator. Siemens also provided a very sophisticated electrical power handling system, which represents the state-of-the-art in power load management.

The vessel can carry 17 segregations of oil product cargoes in conventional tanks, with a total capacity of 12,540m³. At the same time she has the ability to transport **LPG** cargoes in two 640m³ fully-pressurised cylindrical deck tanks. The cargo tanks are epoxy-coated and are fitted with heating coils served by deck-mounted manifold valves and 16 deepwell pumps. This enables the vessel to achieve quick turnarounds in port.

Much of the LPG equipment was supplied by Wärtsilä Hamworthy KSE and included the tanks, all valves and instruments, a cargo heat exchanger, and two four-stage centrifugal LPG cargo pumps, each with capacity of 100m³/h at 10 bars. Additionally, the ship is fitted with a floating discharge hose of 500m length with a storage drum. Designed to load fully refrigerated

Combustible

LPG at -48°C , the containment system is fully pressurised so there is no need for onboard reliquefaction as LPG is discharged at ambient temperature and corresponding pressure.

Length, oa: 120.48m, Length, bp: 117.10, Breadth mld: 23.80m, Depth mld: 9.50m, Draught design/scantling: 6.10/6.53m, Deadweight design/scantling: 8600/9996dwt, Lightweight: 4733 tonnes, Service speed: 13.0 knots, Cargo capacity: 12,375m³.

Combustible, also flammable or **inflammable** – Capable of being ignited easily and burnt.

Combustible gas indicator – An instrument for measuring the contents of hydrocarbon gas/air mixtures, usually showing the result as a percentage of the lower flammable limit.

Combustion Air Saturation System (CASS) – **NOx** suppression technique developed by Wärtsilä, whereby combustion air is humidified before entering the engine cylinder. In a CASS installation, special Hi-Fog nozzles lead water directly into the air stream after the turbocharger in the form of very small droplets which evaporate very fast in an environment of more than 200°C and 75m/s air velocity. Further heat for evaporation is provided by the air cooler (but acting now as a heater), producing in combustion air with a humidity of around 60g/kg air. With this an amount of water, it is possible to secure NOx levels of less than 3g/kWh.

Commanding view – View without obstructions which would interfere with the navigator ability to perform all immediate tasks.

Comminuters – Ships operating primarily beyond 3 nautical miles from the nearest land are encouraged to install and use comminuters to grind food **wastes** to a particle sizes capable of passing through a screen with openings no larger than 25 millimeters.

Commodity – Article shipped. For dangerous and hazardous cargo, the correct commodity identification is critical.

Common-rail injection system – A fuel supply system in which two or more high-pressure pumps supply a common manifold or rail. Timing valves determine the timing and extent of fuel delivery to the cylinder injectors. The benefits of common rail technology are smokeless operation, lower, stable running speeds (down to about 10 rpm for 2-stroke engines) and reduced fuel consumption at part load.

With mechanical injection systems the fuel injection pressure is a function of engine speed and engine load. When the injection pressure drops at lower loads, the fuel droplets grow bigger and there is not enough time to complete combustion of these droplets. The result is the cloud of smoke. Common-rail injection technology offers the possibility to maintain high injection pressure all the way down to idling and to achieve “no smoke at any load”.

The common rail is a manifold running along the length of the engine at just below the cylinder cover level. It provides a certain storage volume for the fuel oil, and has provision for damping pressure waves. Fuel is delivered from the common rail through a separate injection control unit for each engine cylinder to the standard fuel injection valves. The control units regulate the timing of fuel injection, control the volume of fuel injected, and set the shape of the injection pattern. The three fuel injection valves in each cylinder cover are separately controlled so that they may be programmed to operate separately or in unison as necessary.

A major seamark was passed on 18 September 2001 when the sea trials of the new 47,950dwt **bulk carrier** GYPSUM CENTENNIAL were successfully completed. The vessel is propelled by the world first low-speed diesel engine with common-rail fuel injection: the Wärtsilä Sulzer 6RT-flex58T-B developing 11,275 kW at 93 rev/min. This engine has no

Picture courtesy of Wärtsilä Corporation



Self-unloading bulker GYPSUM CENTENNIAL

standard **camshaft** and its gear drive, fuel injection pumps, exhaust valve actuator pumps and reversing servomotors. It is equipped with a common-rail system for fuel injection and exhaust valve actuation, as well as full electronic control of these engine functions. The first commercial 4-stroke engine with common rail entered service in early 2001, with a Wärtsilä 9L46D on board a cruise vessel CARNIVAL SPIRIT.

Communication workstation – Workstation for operation and control of the equipment for distress/safety communication and public correspondence communication.

Commutation – The switching action which transfers the current from one arm of a bridge to the next one, that is to conduct.

Forced commutation – A commutation process where energy sources within the converter are used to affect the transfer of current from one arm of the bridge to the next one.

Natural commutation – A commutation process which relies on the AC system to provide energy to affect the transfer from one arm of the bridge to the next one.

Compactor – A machine used onboard to reduce the volume of garbage produced on a ship by compacting it under pressure. Compactors are mainly used aboard passenger ships. Compacting requires storage space on board sufficient for the duration of the cruise or until the ship calls at a port with reception facilities.

With a compression ratio up to 20:1, FWS 2400 unit can handle most waste from cardboard to bottles. General garbage is compressed into a bag. Other waste products are bailed. Typical bail weight equals to 22-68kg. Waste is added between repeated compactions until the full alarm sounds, when the unit has to be emptied.

Companionway – An access hatchway in a deck, with a ladder leading down, generally for the crew.

Company – The owner of the ship or any other organization or person such as the manager, or the bareboat charterer, who has taken the responsibility for operation of the ship from the owner of the ship.

Company Security Officer (CSO) – The company official from the ship operator who will be responsible for developing, maintaining and enforcing the company security policies as set out in the **Ship Security Plan**.

Compartment – An internal space separated by **bulkheads** or plating.

Compartmentation – The subdividing of the hull by transverse watertight bulkheads so that the ship may remain afloat under some conditions of flooding.

Compass – An instrument using either a magnet or a gyroscope for steering or taking navigational bearings.

Gyrocompass – An electrically-driven gyroscopic disc spinning at extremely high speed which keeps its relative axis in relation to space.

Magnetic compass – A magnetised needle which points to the magnetic North. Some corrections are needed because the magnetic North is not coincident with the true north and the magnetism of the ship itself has to be neutralized.

Compass adjustment – The process of placing magnets and iron masses so as to neutralize the effect of magnetism existing or induced in the ship hull, with the purpose of correcting the error so caused and bringing the compass needle to point as nearly as possible to the magnetic north.

Compatibility of goods – Indicates whether different goods can be safely stowed together in one cargo space or in adjacent holds.

Complement – The number of officers and crew employed upon a vessel for its safe navigation and operation.

Complete fusion, complete joint penetration, complete penetration – A joint root condition in a groove weld in which weld metal extends through the joint thickness.

Composite boiler – A firetube boiler which can generate steam by oil firing or the use of diesel engine exhaust gas.

Compression bar – A steel bar fitted on hatch coaming upper plate against the seal, providing a weathertight joint.

Compression ignition engine – Internal combustion engine that uses the heat of compression to initiate ignition to burn the fuel, which is injected into the combustion chamber during the final stage of compression.

Compression ratio – Ratio of the maximum to minimum volume in the cylinder of an internal combustion engine.

Computational fluid dynamics (CFD) – A technique using numerical methods and algorithms to solve and analyze problems that involves fluid flows. CFD analysis has come to be widely used over the whole range of design from aircraft conception to improving efficiency of water turbines, from the gas dynamics of internal combustion engines to interaction between the hulls of ships and their propellers. A great range of propeller design problems such as propeller-induced hull pressures, character of cavitation, etc, are becoming possible to be solved by CFD methods.

Condenser – A **heat exchanger** in which a vapour is deprived of its latent heat of vaporization and is changed to its liquid state, usually by cooling at constant pressure.

Steam surface condenser – A gas-tight chamber that is fitted with heat-conductive tubes through which cooling water is circulated, and which is provided with means for continuously removing the condensed steam and noncondensable gases. The condensing process is accomplished by the heat transfer from the exhaust steam to the cooling water.

Condition Assessment Programme (CAP) – A voluntary system which gives a detailed assessment of the tanker present condition at the time of inspection. CAP is available to both charter-parties and owners.

Condition assessment scheme (CAS) – Inspection of a vessel to determine its technical condition.

Condition survey – Normally a survey of limited scope and time, intended to identify any anticipated structural or corrosion-related deficiencies, and give an overall visual impression of the structural integrity.

Conductivity – The reciprocal of resistivity. It is expressed as the ratio of the current density to electric field strength and is expressed in siemens per metre.

Conductor –

1. A material that offers a relatively low resistance to the passage of electric current.

2. A large-diameter steel pipe used as the foundation for drilling operations.

The conductor may be installed into a pre-drilled hole and secured with cement, or it may be piled into the seabed.

Confined space – A space identified by one of the following characteristics: limited openings for entry and exit, unfavorable natural ventilation or not intended for long worker occupancy.

Connecting rod – The rod connecting the crankpin of a reciprocating engine to the **piston** or the **crosshead**.

Photo courtesy of Wärtsilä Corporation

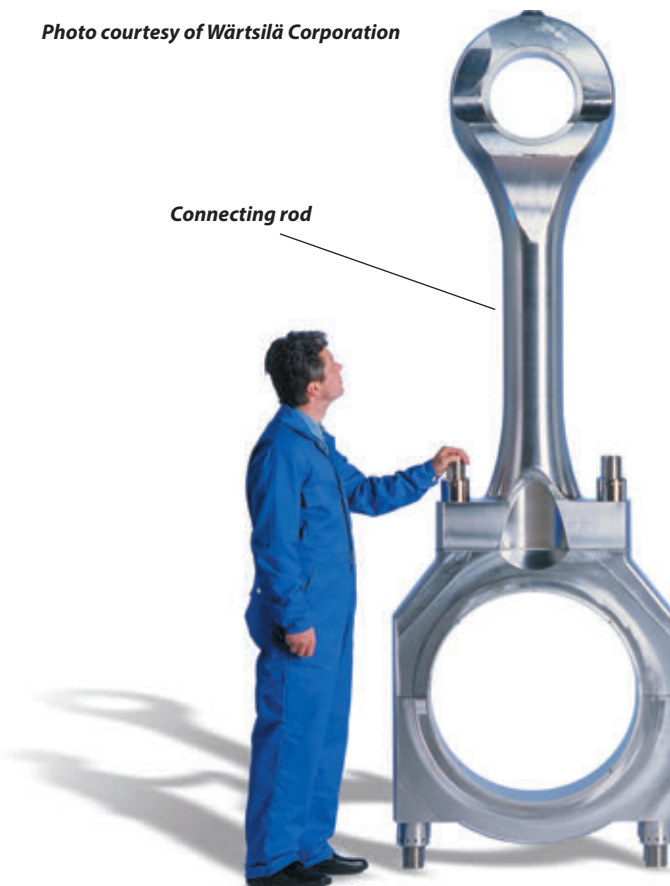

Conning display – The visual display unit which provides data essential for the precise and safe navigation in a clear and visible format capable of being read at some distance from the screen.

Conning position

Conning position – The place in the **wheelhouse** with a **commanding view** and which is used by **navigators** when commanding, maneuvering and controlling a ship's movements. Regulations on Navigation on Panama Canal Waters define the following normal conning positions:

- Conning Position No.1 is located directly behind and close to the forward centre wheelhouse window.
- Conning Position No.2 is located to port of Conning Position No.1, directly behind and close to the nearest window, thereto, so that it provides a clear, unobstructed view ahead.
- Conning Position No. 3 is located to starboard of Conning Position No.1
- Conning Position No. 4 is located at the extreme end of the port **bridge wing**.
- Conning Position No. 5 is located at the extreme end of the starboard bridge wing.

Conradson carbon value – The measure of the percentage of carbon residue after controlled evaporation of the fuel in a closed space.

Con-ro carrier TIMCA

According to Significant Ships of 2006

Designed and built by Stocznia Szczecińska Nowa the con-ro vessel TIMCA can carry trailers and semi-trailers, commercial vehicles and trucks, as well as MAFI trailers and cassettes, paper reels, and containers. Ro-ro access is over stern ramps to the main deck, with fixed internal ramps linking the three continuous cargo decks. Shore cranes serve the other cargo spaces, including an open-top container hold forward. Aft of the superstructure, removeable cell guidea are fitted for more containers.

Photo courtesy of New Szczecin Shipyard



Three 6000 m³/h electric air dryers are positioned in the holds to protect forest product cargoes from damp weather conditions, whilst damage to cargo by ship movement is restricted by the installation of a pair of Mitsubishi 9m² retractable fin stabilisers. An air-actuated Rolls-Royce Interling 3000m³ anti-heeling system controls list during cargo handling operations.

TIMCA features a twin-screw arrangement with a Wärtsilä power plant based on a pair of 12V46C main engines. Each develops 12,600kW at 500rpm and drives Wärtsilä-Lips CP propeller through Renk reduction gearbox. The propellers operate in conjunction with

two Wärtsilä **Efficiency rudders**. The total machinery package also includes two Wärtsilä 8L20C/A. Van Kaick 1615kVA diesel-alternators, supplementing the output from a pair of A. Van Kaick 2125kVA generators driven from the main engines. All four engines are arranged to burn RMH55-grade heavy fuel oil.

Length, oa: 205.20m, Length, bp: 190.00m, Breadth, mld: 25.50m, Depth, mld, to main deck: 9.00m, Draught design/scantling: 7.22/8.52m, Deadweight design/scantling: 11,776/17,450 dwt, Lightweight: 13,200 tonnes, Output: 2x12,600kW at 121rpm, Service speed at 85%MCR: 22.70knots, Cargo capacity (bale): 42,414m³.

Consignee – The person to whom goods are shipped.

Console – A control panel, often the central unit, from which an operator can operate and supervise machinery or equipment.

Constructive total loss (CTL) – The loss of a vessel under insurance terms, when repair costs exceed the value of the vessel itself.

Consumables – Items consumed during the welding process, namely electrodes, filler wires, fluxes and shielding gases.

Contact damage – The damage occurred when a ship comes into contact with other ships and/or a permanent structure such as quayside. Contact damage usually happens during manoeuvring procedures in harbours.

Contact – An electrical switch that is designed to open and close a circuit frequently and is not operated manually.

Container – A large steel box designed to allow goods to be sent from door to door without any handling from the initial packing to final discharge. Containers may be ventilated, insulated, refrigerated, flat rack, vehicle rack, open top, bulk liquid or equipped with interior devices. A container may be 20 feet, 40 feet, 45 feet, 48 feet or 53 feet in length, 8'0" or 8'6" in width, and 8'6" or 9'6" in height.

The most common sizes are 20 ft long by 8 ft wide by 8.5ft high and 40ft long, with other dimensions similar to the 20-footer. A lot of useful information can be found on www.containerhandbuch.de

Container block – A number of **container stacks** interconnected and secured horizontally by bridge stackers.



Photos: J. Babicz

Container cell guides – Containers are commonly stowed below deck and sometimes on deck within fixed vertical cell guides, which guide them into place and ensure that they do not move during the voyage.

Rolled container guides – Special T-shape profiles used as slim container guides.

TIMCA

Plans courtesy of New Szczecin Shipyard

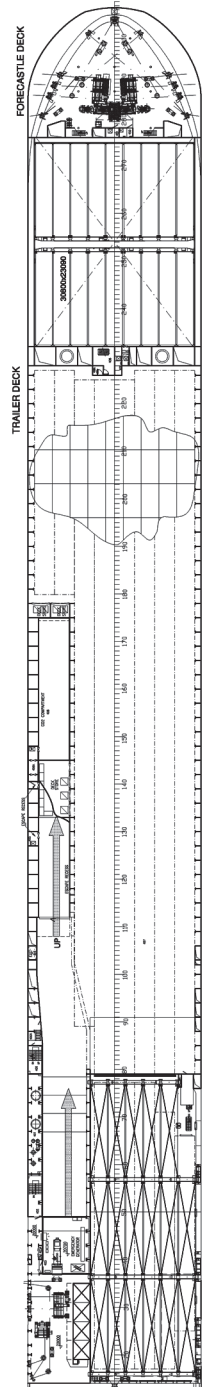
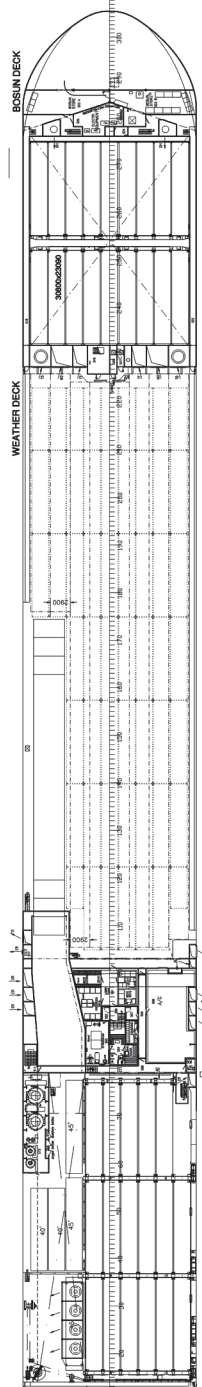
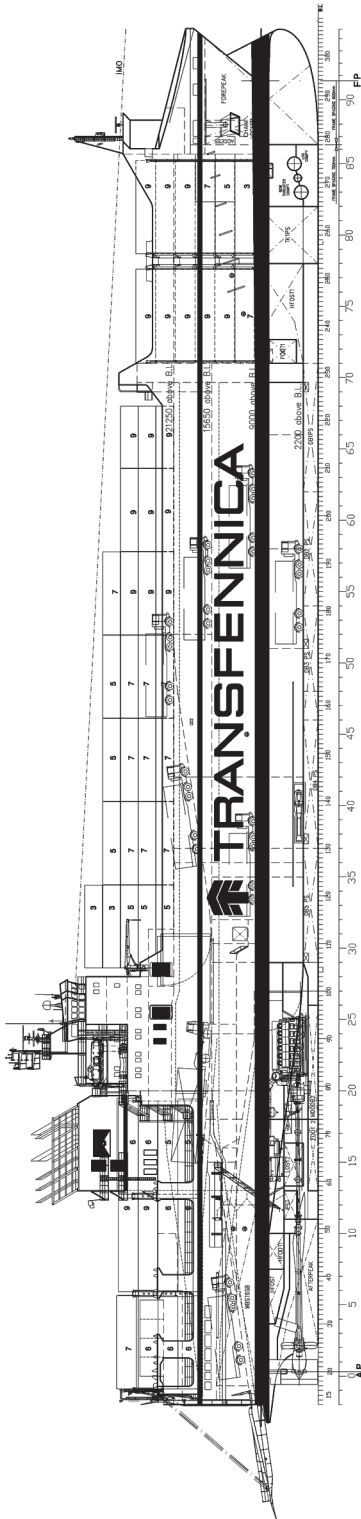

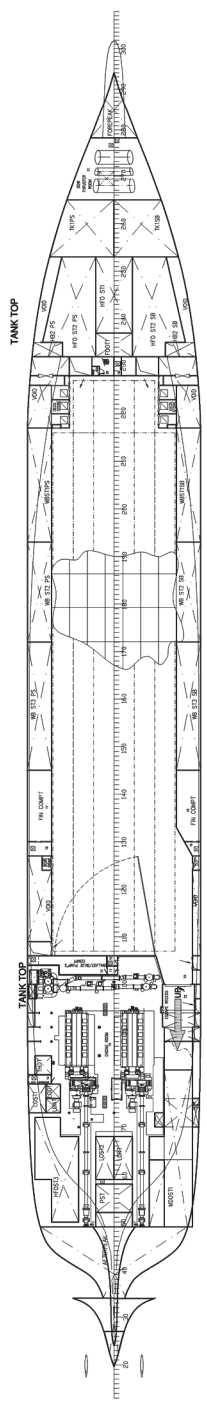
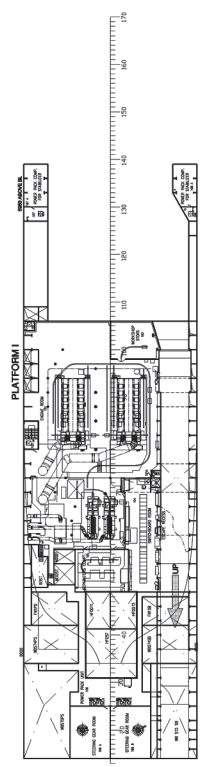
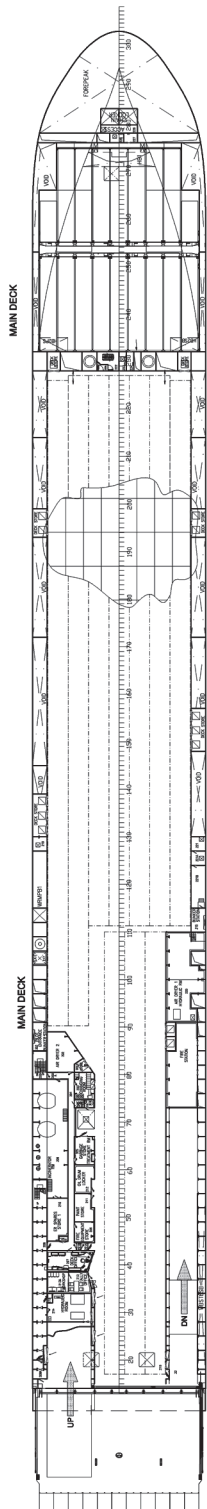

$L_{OA} = 205.20M$, $L_{BP} = 190.00M$, $B_{MLD} = 25.50M$, $DRAUGHT = 7.22/8.52M$

Container lashing equipment

Container lashing equipment, also container-securing equipment – Fixed and loose fittings used for the reliable securing of containers.

Fixed fittings – Stacking cones, foundations, deck foundations, lashing plates, lashing eyes, lashing pots, d-rings. Fixed fittings are integrated into the hull structure or fitted on double bottom or hatch covers.

Loose fittings – Twistlocks, stackers, bridge fittings, tension/pressure elements, spanners, lashing rods and turnbuckles.

Open turnbuckles combined with multi knob rods are used to secure containers of different heights with one rod length. For rapid adjustment and safe connection the turnbuckle is equipped with a slide nut. 50t breaking load systems are used almost exclusively (26mm rod diameter).

Container Securing Manual – A stowage and lashing plan approved by the **classification society**. It describes the application of the loose lashing equipment and the corresponding weight distributions for all container stacks.

CONTAINER SHIPS

Ships intended exclusively for the carriage of containers and equipped with the appropriate facilities. Such vessels have cellular holds with cell guides attached to bulkheads and container foundations. They can be provided with lift-away **hatch covers** (the usual solution for bigger vessels), or with folding hatch covers that need more space on deck when open. Deck containers are carried up to 7-high and secured by system of lashing. The capacity of a container ship is expressed in TEU that is twenty-foot equivalent units.



2127TEU geared container vessel CONTI SALOME built by Aker Yards, Germany

Two four-stroke diesel engines Wärtsilä 9L46D (2x10,395kW) drive a single CP propeller through a twin-in/single-out reduction gear. If the vessel is operating at low speed or in light ship conditions it can run just one engine. The ship is provided with three auxiliary engines Wärtsilä 8L20, 3x1600kW, and one shaft generator 1300kW.

Originally developed for the U.S. for Puerto Rico trade, the container vessel was slowly emerging in the maritime area in the 1950s. Conversions of existing tonnage preceded the first purpose-built containership the Gateway City designed in 1956/7. The development in the container market was slow until 1968, when deliveries reached 18 vessels. Ten of them had a capacity of 1000-1500TEU. In 1972, the first vessels with a capacity of more than 3000TEU were delivered from the German HDW shipyard. They were the largest container ships until the delivery in 1980 of 4100TEU NEPTUNE GARNET.



Photo courtesy of MacGREGOR

Container lashing equipment

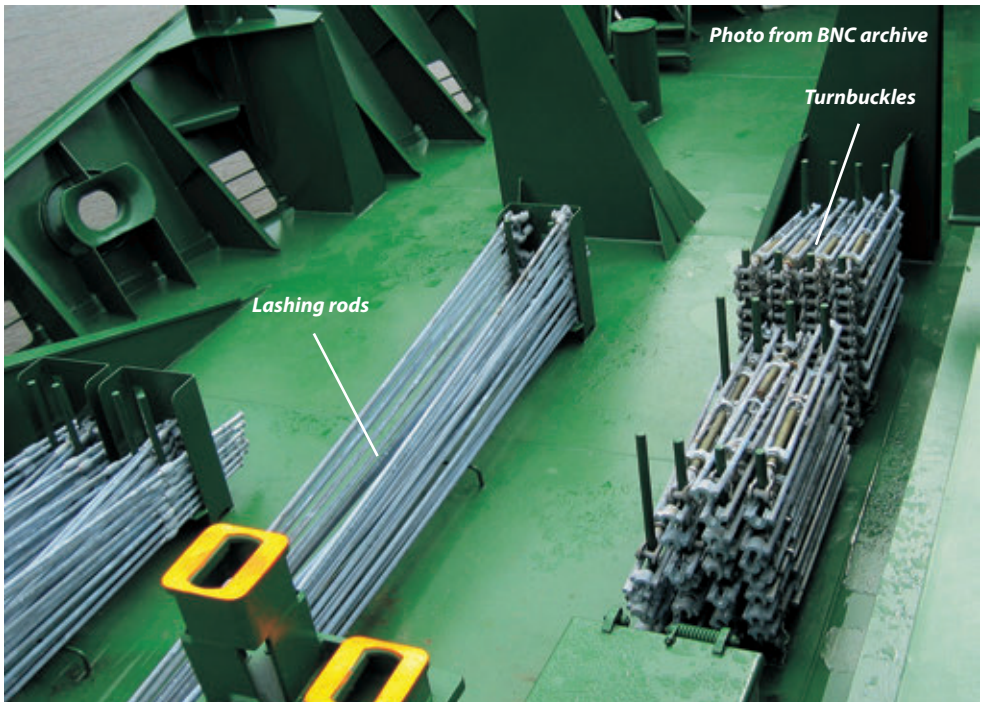

Photo from BNC archive

Turnbuckles

Lashing rods

Stowage of lashing rods and turnbuckles

CONTAINER SHIPS

When the size of container ships increased to 4500-5000TEU, it was necessary to exceed the Panama maximum breadth of 32.3m and in 1988 the first post-Panamax container ship was built. In 1996 the REGINA MAERSK with an official capacity of 6600TEU started a new era. The maximum size of container ships has rapidly increased to 7200TEU in 1998, and up to 9600TEU for ships delivered in 2006. Recent years have seen the advent of very large container ships with capacity exceeding 13,000TEU.

Feeders – Very large longhaul vessels have created a parallel need for fast, cost effective vessels as feeders and for regional distribution. Feeder containerships are often geared, their deck cranes facilitate cargo handling in ports with limited infrastructure. Small feeders (below 1000TEU) are normally applied for short-sea transport. The feeders with capacity 1000-2500TEU are normally applied for feeding very large vessels, but are also servicing markets and areas where the demand for large container vessels is too low.



Photo: P-H. Sjöström

Feeder vessel: note the enclosed bridge

Hatchcoverless container ship, also open-top container ship – The concept of the containership without hatch covers developed to reduce turnaround time in port and cargo handling costs by eliminating the need to remove and replace covers, and to fit and remove twistlocks and lashing the deck containers. To prevent flooding, the open-top vessel has the increased freeboard and **bilge**-pumping system designed with the capacity to cope with the volume of water predicted to enter the open holds during the worst sea conditions and severe tropical storms.

Eliminating the hatch covers allows continuous cell guides to extend from the holds to secure the deck containers. The hatchcoverless concept offers the benefit of safe container stowage without the lashing. Furthermore, the open ship configuration gives considerable advantages with respect to heat disposal from cargo holds.

The first hatchcoverless containership was WESTPHALIA: a converted barge carrier completed as JOSEFA TORRES by the Sestao yard of Astilleros Espanoles in 1983. All the design and certification work as a hatchless containership was done by V.Ships of Monaco. Cell guides were manufactured and fitted by RNL at Dunkirk, France. WESTPHALIA entered service in January 1989, and made two round trips to Australia before starting a feeder service in the Arabian Gulf. She calls at ports in the United Arab Emirates, Saudi Arabia and Kuwait, and everyone agrees that the cell guide concept without hatch covers saves a significant amount of port time. The ship was classed by the ABS and flies the Liberian Flag.

Amongst the earliest hatchcoverless vessels were BELL PIONEER and EURO POWER which came into service in September 1990 and September 1992 respectively. These vessels have been employed in intensive short-sea services both in the Pacific and European regions, and have encountered severe weather conditions, including tropical storms and high wave conditions. During this time, containers neither have suffered water damage, nor have been crushed in the cell guide system.

The largest hatchcoverless container vessel, the 4112TEU capacity NEDLLOYD HONGKONG was delivered in February of 1994 by Kure Shipyard of Ishikawajima-Harima Heavy Industries. The ship has been designed purely as a larger, post-Panamax version of the earlier Nedlloyd Asia class and designated as "The Ultimate Container Carrier".

To cope with water intake in the holds of NEDLLOYD HONG KONG, two separate pumping systems have been arranged to serve the fore and after ends of each compartment. Container sockets in holds are 30cm higher than on conventional ships to allow water ingress to flow freely underneath. Gutters running along either side of the hold lengths drain water into the four bilge wells. Activation of the pumping system is either by automatic level controllers or by manual operation. See also **Hatchcoverless container ship NORASIA FRIBOURG** and **Open-top reefer container vessel DOLE COLOMBIA**.

	Ship	Year	Yard	L _{BP} (m)	B (m)	D (m)	d (m)	TEU	Tiers	MCR (kW)	V (knot)
1	Westphalia										
2	Bell Pioneer	1990	Teraoka	106.0	16.92	12.52	5.20 7.52	300	6	3,000	14.5
3	Nedlloyd Asia	1991	IHI Kure	253.0	32.24	23.25	11 13	3,568		30,600	21.5/23
4	Atlantic Lady	1992	Verolme	160.0	28.80	16.80	8.0 9.0	1,472	10	9,830	
5	Norasia Fribourg	1993	HDW	229.5	32.24	23.00	11 12	2,780	11	27,290	22.5
6	Nedlloyd Hongkong	1994	IHI Kure	265.0	37.75	23.25	12.50	4,112	13	41,260	24
7	Norasia Salome	1998	HDW	198.74	26.66	18.95	8.70 9.50	1,427	9	24,000	25
8	Dole Chile	1999	HDW	193.4	32.24	20.80	9.25 10.20	1,980	11	23,920	21

Panamax container ship – A vessel of no more than 294.3m long and 32.3m wide to cross the Panama Canal. The capacity of such dimensioned vessels has developed a very long way from the 3000TEU of the early 1970s versions, to the 5100TEU intake of optimized Panamax containerships.

Ultra large container ships – The size of container vessels has been dramatically increasing in recent years, exploiting the advantages resulting from the economy of scale. The MAERSK ELBA with beam 48.2m (17 rows in hold and 19 rows on deck) has capacity of 13,100TEU and weights over 43,000t. The CMA CGM MARCO POLO has beam 53.6m and capacity of 16,000TEU.

In June 2013 Maersk Line's first 18,270TEU Triple-E containership was delivered by the Daewoo Shipbuilding and Marine Engineering shipyard at Okpo. Currently, the largest container vessels on order are of 18,400 TEU in size.



One two-stroke diesel engine Wärtsilä 12RTA96C, 68,640kW at 102 rpm, six-bladed FP propeller of 8555mm diameter.



13,100TEU vessel MAERSK ELBA
“Two islands” concept with accommodation separated from the engine room is characteristic for mega container ships

While in the past the selected design speed has been approximately 25 knots and higher, lately the preferred design speed has been reduced to 23–24 knots, and even lower. The dual engine installation of Triple-E vessels is intended to ensure a top speed of 23kts, 2 knots less than that of the 15,500TEU EMMA MAERSK. Despite of the 16% increase in payload, the power requirement is in the order of 65,000–70,000kW, some 19% less than 80,000kW, single-engine installation in EMMA MAERSK.



Photo courtesy of MacGREGOR

ESTELLE MAERSK 15,500 TEU
 Maersk Line PS-class mark the introduction into service
 of the first 14-cylinder RT-flex96C Wärtsilä engines developing 80,080kW

MEGA CONTAINER SHIPS

	HYUNDAI TOGETHER	HAMBURG EXPRESS	CSCL STAR	CMA CGM MARCO POLO	MAERSK TRIPLE-E
Shipyard	HSHI	HHI	Samsung	DSME	DSME
Year	2012	2012	2011	2012	2013
L _{OA} (m)	366.53m	366.45m	366m	396.0m	399.0m
L _{BP} (m)	350.00m	350.00m	350m	378.4m	374.4m
B (m)	48.20m	48.2m	51.2m	53.6m	59.0m
D (m)	29.85m	29.85m	29.9m	29.9m	30.3m
Design draft	14.5m	14.5m	14.5m	14.0m	14.5m
Max draft	15.5m	15.5m	15.5m	16.0m	16.0m
DWT design	126,000dwt	127,170dwt	139,200dwt	149,470dwt	166,500dwt
DWT max	141,000dwt	142,092dwt	155,400dwt	186,470dwt	196,050dwt
TEU Capacity	13,082	13,169	14,074	16,000	18,340
In holds	6008	6064	6416	7,400	7696
On deck	7074	7105	7658	8,600	10,644
Bays in holds	21	21	21	22	22
Bays on deck	22	22	22	24	24
Rows	17/19	17/19	18/20	19/21	21/23
Stability TEU	8927	9074		12,000	10,562
LBD (m ³)	503,569m ³	503,569m ³	535,808m ³	606,439m ³	
LBD/stability	56.41m ³ /TEU	55.50m ³ /TEU		50.54m ³ /TEU	
Reefer plugs	800	800	1000	800	600
MCR (kW)	72,240kW	58,274kW	72,240kW	80,080kW	59,360kW
Service speed	24.7kn	23.6kn	24.2kn	25.1kn	23.0kn
Engine Consumption	270t/day	214.4t/day	261.4t/day	288.5t/day	

Container stack – Containers which are stacked vertically and secured horizontally by stackers, lashing etc.

Container stack load – Hatch covers for Panamax ships have stack weights up to 90 tonnes/20ft units and 120 tonnes/40ft units. Post-Panamax vessel could have 100 tonnes/20ft and 140 tonnes/40ft units.

Container stowage in holds – The standard 40ft containers (FEU) are stowed in cell guides without any lashing devices. If there is also a certain number of 20ft units (TEU) available at all time, the creation of a hold with 20ft guides may be considered. In most cases, 40ft cell guides are installed exclusively and TEUs are stowed in the 40ft bays. This, however, needs securing job.

There are basically 3 systems to stow TEUs into 40ft cell guides:

1. Side support stowage system.

The containers are connected with double stacking cones in a transverse direction. At the longitudinal bulkhead, you have either a fixable installed guide rail or foundations for buttresses that take up the load. This is the most conventional system. The containers can be loaded/removed only tier wise.

2. Stowage with anti-rack spacers.

The containers are connected longitudinally with so called “anti racking spacers”, thus creating out of two 20ft containers one 40ft-unit. This system avoids side supporting, that means a 20ft stack can neighbour a 40ft stack and there are no foundations or rails in the longitudinal bulkhead. The disadvantage is that the containers have to be loaded/removed also tier wise.

3. Mixed stowage

The third system becomes more and more popular with regard to the a.m. disadvantages: the mixed stowage. Starting from the tank top you can stow from one to four tiers 20ft containers (secured only by single stacking cones) and top them up with at least one FEU. This system allows stack wise loading/discharge. The only disadvantage is that the stackweight of the TEUs is reduced a bit to about 60 ton.

The new size containers make another problem. Most easily they can be stowed on deck installing additional foundations on hatch covers.

Container stowage on deck – Ship motions impose heavy loads on the deck cargo which would soon move unless secured in place. Containers carried on deck may be secured by twistlock alone. The integrity of the stow then relies on the racking strength of the containers. Up to approx. 50t stackweight, the lowest container is able to carry the transverse and longitudinal forces on top by itself. With higher stackloads, the stack must be “reinforced” by lashing bars: single or double cross lashings depending on the stackweight. The effectiveness of double lashings is 1.5 times that of single lashing, unless a load-equalising device is fitted. The general principle is that securing in the forward part of the ship are designed to be suitable for forces increased by 20%, unless a breakwater or similar substantial protection is fitted.

The 40ft ends have a lashing gap of minimum 700mm, so that lashing can be applied. If two 20ft containers are positioned on one 40ft place, the gap is 76mm wide and it is not possible to use lashing and the stack weight is limited to 50t.

It is a rare practice to link adjacent stacks of containers. Skiiping the job substantially simplifies loading and discharging operations. It is, however, sometimes necessary to link an outboard stack to the adjacent stack to help resist wind loading.

At a wind speed of 90 miles per hour, the wind force is about 2 tonnes on the side of a 20-foot box and about 4 tonnes on a 40-foot box.

Container ships are likely to be driven hard in order to maintain very tight operating schedules. As a consequence, thousands of containers are lost overboard every year and continue to be the source of substantial claims for P&I clubs.

Container Terminal – An area designated for the stowage of containers; usually accessible by truck, railroad and marine transportation. Containers are picked up, dropped off, maintained and housed there.

Containerization – Stowage of general or special cargoes in a **container** for transport in the various modes.

Container load – A load sufficient in size to fill a **container** space either by cubic measurement or by weight.

Continuous Synopsis Record (CSR) – A new **SOLAS** Regulation XI-1/5 requires ships to be issued with a CSR, which is intended to provide an on-board record of the history of the ship. The CSR shall be issued by the Administration and shall contain information such as the name of the ship and of the State whose flag the ship is entitled to fly, the date on which the ship was registered with that State, the ship identification number, the port at which the ship is registered and the name of the registered owner(s) and their registered address. Any changes shall be recorded in the CSR so as to provide updated and current information together with the history of the changes.

Continuous weld – A weld that extends continuously from one end of a joint to the other. If the joint is circular, it extends entirely around the joint.

Control – The process of conveying a command or order to enable the desired action to be done.

Automatic control – A means of control that conveys predetermined orders without operator action.

Local control – A device or a station located on or close to a machine to enable its operation within sight of the operator.

Remote control – A device or array of devices connected to a machine by mechanical, electrical, pneumatic, hydraulic or other means and by which the machine may be operated remotely from, and not necessarily within sight of the operator.

Control and Communication Centre (3C)

The Wärtsilä 3C is a fully integrated vessel control system with a single interface. It allows the seamless integration of all the essential vessel control systems, and covers the world's first type approved integrated navigation system from a proven partner. The system provides a vital link between the bridge and the ship's automation, engines, and propulsion control systems.

3C consists of multifunction displays covering full workstations with radar, ECDIS and conning, various sensors for target detection, heading, position and further navigation data with standardised user interfaces. 3C is based on know-how and components that are well known for their outstanding precision and reliable design. The control centre fulfils basic IMO requirements as well as highest class notations for one-man bridges. The use of standard hardware and software allows the configuration of modular system solutions, from the tanker or containership through the offshore supply ship and the mega yacht to the cruise ship. **For further information please visit www.wartsila.com**

Picture courtesy of Wärtsilä Corporation



Control and Communication Centre (3C)

Control stations – Those spaces in which the ship radio or the main navigating equipment or the emergency source of power is located, or where the fire recording or fire control equipment is centralized, (SOLAS).

Centralized control station – A propulsion control station fitted with **instrumentation, control systems** and **actuators** to enable propulsion and auxiliary machinery be controlled and monitored, and the state of propulsion machinery space be monitored, without the need of regular local attendance in the propulsion machinery space.

Remote control station – A location fitted with means of **remote control** and monitoring.

Control system – An arrangement of elements interconnected and interacting in order to maintain, or to affect in a prescribed manner, some condition of a body, process or machine, which forms part of the system.

Control valve – A valve that regulates the fluid flow. It is usually operated remotely as the regulating unit of an automatic control system. The actuator may be pneumatic, electric or hydraulic in operation.

Controlled atmosphere (CA) – To stop the ripening process and to preserve the quality of fruit, vegetables, flowers or other perishable goods during sea transport, Controlled Atmosphere (CA) has proved to be an ideal solution. By introducing and maintaining a nitrogen-rich atmosphere in the cargo holds, the respiration rate of the goods can be reduced to a minimum, ensuring top quality at the destination. Typically the storage time of most perishable goods can be extended by 3-5 times without any loss in quality.

Controlled atmosphere (CA) system – One of the standard features of modern reefer ships is to provide the means of transporting cargo in a controlled or modified atmosphere. The cargo is kept in a nitrogen-rich atmosphere with reduced oxygen content in order to slow down the ripening process of fruit and vegetables to a minimum. The CA units use a Pressure Swing Absorption (PSA) system which separates nitrogen from ambient atmospheric components.

Unitor CA systems – Unitor has designed a range of CA systems for permanent installation onboard new reefer ships as well as transportable units built into standard 20feet container

for existing ships. Typical Unitor CA systems will have capacity from 300-600 m³/h at 95-96% Nitrogen and are based on Generon Hollow fibre membranes for air separation. The system itself includes feed air compressors, filters, and sophisticated control and monitoring system.

Conventional paints – A collective description for paints based on binders such as bitumen, alkyds and oils.

Converter – A circuit that converts AC to DC or from DC to AC or acts as AC frequency changer. Modern electric drive systems, in which speed control of the electric motor is required, use power supply converters. These converters adapt the voltage and frequency of the power supply to the electric motor as required for the desired motor speed. The basic components of the converters are **diodes, transistors** and **thyristors**.

Cyclo-converter – A cyclo-converter is a single-stage (AC-AC) converter and converts AC with a constant frequency directly to an AC with a varying frequency, as required for the desired motor speed.

Cyclo-converters are used to power and control the speed of synchronous motors. Motor speed is adjusted by changing the frequency of the motor's supply and allows full torque over the speed range in either direction. As cyclo-converters produce relatively low frequencies, they are more associated with direct drive low-speed motors.

Pulse Width Modulation (PWM) converter – PWM converter has a dual conversion process (AC-DC-AC) and uses a DC link. PWM converters are used to power and control the speed of asynchronous motors.

Pulse width modulation (PWM) uses a rectifier to create DC voltage in the same way as a synchro-converter. On the inverter side it uses forced commutation to give a series of pulses of common voltage both positive and negative. In this way the output voltage can be made to approximate AC, while varying of the pulse number and width can increase or decrease the frequency. In marine propulsion terms they are at the low end of the power band (up to 8MW) and as frequency increases, the output wave becomes increasingly distorted.

Synchro-converter – Synchro-converter is AC-DC-AC converter : it converts three phase AC with a constant voltage and frequency to a DC with a varying voltage and then again to a three phase AC with varying voltage and varying frequency. It can be used only in combination with a synchronous motor. To increase the motor speed, the current is increased, which creates higher magnetic forces and torque. This, in turn, causes the rotor to move faster which commutates the thyristors more quickly, increasing the AC frequency until the required speed is reached.

Synchro-converters can produce frequencies in excess of 100Hz and are suited to high-speed motors.

Conveyor system – The entire system for delivering bulk cargo from the shore stockpile or receiving point to the ship.

Convoy – A group of vessels sailing together, e.g. through a canal or ice.

Cooler – A heat exchanger where hot air or liquid is cooled by seawater or by fresh water. Coolers fall into two groups, shell and tube, and the plate type.

Co-ordinator surface search (CSS) – A vessel, other than a rescue unit, designated to co-ordinate surface search and rescue operation within a specified area.

Copper – A ductile metal, which has good electrical conductivity and is widely used in electrical equipment. It has a high resistance to corrosion and also forms a number of important alloys, e.g. brass and bronze.

Corex panels – Stainless steel sandwich panels developed by MacGREGOR company for fixed and hoistable car decks on ferries and **ro-ro ships**.

Corner joint – A joint between two elements located approximately at right angles in the form of L.

Corner pad – A shaped seal unit to go around right-angled or compound corners.

Corrosion – The process of deterioration of metals and their properties, following a reaction with surrounding environment.

Corrosion usually occurs first in a tank around its corners, welds and edges of the structure.

Active corrosion – Active corrosion means gradual chemical or electrochemical attack on a metal producing loose scale by atmosphere, moisture or other agents.

Anaerobic corrosion – Corrosion occurring in the absence of oxygen.

Bacterial corrosion – Corrosion caused by certain bacteria, particularly sulphate reducing anaerobic bacteria. Such corrosion develops under corrosion deposit product, or in deaerated seawater circuits.

Crevice corrosion – An intense localised form of corrosion, usually associated with small volumes of stagnant solution resulting from holes, masked surfaces or crevices.

Edge corrosion – Local corrosion at the free edges of stiffeners, brackets, flanges, manholes etc.

Electrochemical corrosion – Corrosion due to the passage of an electric current. If the current is produced by the system itself the corrosion is called galvanic and if it results from an impressed current it is called electrolytic corrosion.

Erosion corrosion – A combined action involving corrosion and erosion in the presence of a moving **corrosive fluid**, leading to the accelerated loss of material. Erosion corrosion is characterized by grooves, gullies, waves, valleys etc., usually with directional pattern and with bright surfaces free from corrosion products.

Galvanic corrosion – This type of corrosion occurs when two metals or alloys are electrically in contact in a corrosive environment (electrolyte). The less noble metal is attacked; it is called anode. The most noble metal is protected; it is called cathode.

Fretting corrosion – Surface damage, usually in an air environment, between two surfaces, one or both of which are metals, in close contact under pressure and subject to a slight relative motion.

Friction corrosion – Corrosion of metal surfaces that is caused by frictional forces.

General corrosion, overall corrosion – Corrosion evenly distributed on the surface.

Grooving corrosion – Local corrosion normally close to welding joints along abutting stiffeners and at **stiffener** or plate butts or seams.

Localised corrosion – More or less localised corrosion attacks such as pitting corrosion, crevice corrosion, corrosion on welds and on edges.

Pitting corrosion – Local, randomly scattered corrosion mainly on horizontal surfaces and at structural details where water is trapped, particularly at bottom of tanks. On coated areas the attack produces deep and small-diameter pits, which may lead to perforation. Pitting of uncoated areas in tanks, as it progresses, forms shallow but very wide scabby patches (e.g. 300 mm in diameter) and the appearance resembles general corrosion.

Stress corrosion – In this type of corrosion, fractures occur in the material exposed to a corrosive environment and subject to stresses. For example these stresses can be residual stresses of welding or thermal stresses.

Corrosion extent

Excessive corrosion – An extent of corrosion that exceeds the allowable corrosion.

Extensive corrosion – An extent of corrosion consisting of hard and/or loose scale, including pitting, over 70% or more of the area under consideration, accompanied by the evidence of thickness diminution.

Insignificant corrosion, minor corrosion – An extent of corrosion with minor rusty spots. The assessment of the corrosion pattern indicates wear generally up to 30% of the allowable corrosion limits.

Substantial corrosion – Such an extent of corrosion that assessment of corrosion pattern indicates wastage in excess of 75% of allowable corrosion, but within limits.

Corrosion fatigue – The process in which a metal fractures prematurely in a trans-crystalline manner under conditions of simultaneous corrosion and cyclic loading at lower stress levels or fewer cycles than would be in the absence of a corrosive environment.

Corrosion inhibitor – A preventive agent, which is capable of stopping or retarding a chemical reaction; to be useful, it must be effective in low concentration.

Corrosion prevention system – A full hard coating or full hard coating supplemented by cathodic protection.

Corrosion rate – Rate at which the corrosion proceeds. It is the thickness of metal lost during one year, on one side of the surface. It is expressed in mm by year.

Corrosive fluids – Fluids causing damage by coming into contact with living tissues, the vessel or its cargo, when escaped from their containment.

Corrugated – Having a series of arranged wrinkles or grooves to produce stiffness with a reduction in weight.

Cosalt Personnel Recovery Device (PRD) – A new safety equipment for man overboard retrieval situations. The device allows for both conscious and unconscious casualties to be lifted from the water in a safe horizontal position. The Cosalt PRD has plastic rungs and steel rods and is fitted with stainless steel snap hooks. Lifting strops and heaving lines are attached to aid retrieval. The PRD comes in a rescue stretcher configuration, to be used with block and tackle or davit arrangements. The PRD can as well be used as a scramble net over the side of a vessel.

Coselle CNG System – The Coselle CNG System has been developed in cooperation with ABS and DNV to transport compressed natural gas. Each coselle consists of 10 miles of 6-inch diameter pipeline coiled into a carousel and carries 35 mmscf of natural gas creating a large compact storage system. Sea NG, a Canadian Company, purchased the Coselle CNG System and all relevant patents from William Power Company in 2005.

For more information visit www.coselle.com

Coxswain – The person who is in charge of a boat, the rating who steers the boat.

Course – The intended direction of vessel movement.

Cowl – The shaped top of a natural ventilation trunk, which may be rotated to draw air into or out of the ventilated space.

Crack – A fracture without complete separation characterized by a sharp tip and high ratio of length and width to opening displacement.

Crack arrester – A band of tough steel applied as part of the hull structure to prevent a fracture from spreading.

Cracking –

1. A general term for the conversion process, which produces lighter oils from heavy oils. The main types are thermal cracking, catalytic cracking and hydrocracking.
2. A breakdown in which the cracks penetrate at least one coat of paint and which may be expected to result ultimately in complete failure.

Cradle –

1. A form on which bows, etc., are assembled.
2. A lifting base manufactured usually in wood or steel used to accept and support a heavy load. It would normally be employed with heavy lifting slings and shackles to each corner.

Launching cradle – The support on which a ship rests during launching. It consists of a fore-poppet structure and an after-poppet structure both of which move with the ship as it is launched.

Crane characteristics – Parameters such as lifting capacity, max. working radius, min. working radius, hoisting speed, luffing time, slewing speed, slewing angle and weight.

Crane ships – Crane ships can be subdivided into two main categories:

- Large specialized ships and barges equipped with huge cranes and used for offshore construction and installation (see **Crane vessel OLEG STRASHNOV**),
- Floating cranes used in ports and shipyards.

Crane vessel OLEG STRASHNOV

The heavy lift vessel OLEG STRASHNOV was delivered by IHC Krimpen Shipyard in 2010. It has been designed by Gusto MSC/IHC Merwede for the installation and removal of offshore platforms, subsea construction and special projects. The installed DP3 system also enables the vessel to be employed for the installation of large and heavy subsea structures, TLP/Spar foundations and topsides.



Photo courtesy of Huisman Itrec

Crane ship SAPURA 3000 placing topside installation

The vessel's key feature is the dual-draught hull concept. This encompasses a hull design with a small waterline breadth for transit and general construction activities and a significantly larger waterline breadth when additional stability is required for heavy lift operations.

The vessel is fitted with a fully revolving offshore crane with a lifting capacity of 5000 metric tons. Lift heights of 100m for the 5000t main hook and 132m for the 800t auxiliary hook enables the vessel to undertake an impressive range of projects from dual hook upending of large jackets to heavy deck installations.

For main propulsion the vessel is equipped with two fixed-pitch, 5000kW azimuth thrusters aft, augmented in dynamic positioning or manoeuvring mode by two 3500kW retractable thrusters in the midship, and two bow tunnel thrusters of 1145kW apiece. All thrusters were supplied by Wärtsilä.

The power system is based on six 4500kW Wärtsilä 9L32 diesel gensets, rated at 5400kVA at 6.6kV, delivering electrical energy to the board net, including the enormous offshore crane.

As support for DP system during hoisting operations, or to provide an alternative means of position holding, the vessel is fitted with a multi-winch system to serve an anchor spread. This comprises eight single drum winches suitable for 2200m of 76mm steel wire.

The vessel has been designed for future pipelay capability for single and double jointing systems of 6" - 60" pipes with a tensioning system of up to 675t A & R capacity. Main firing line is arranged below main deck and the ship can be equipped with a removable truss-type stinger situated at the aft of the vessel and a stinger handling system.

Maximum operating conditions	Lifting	Pipelaying	Standby Abandoning pipe
Significant wave height	2.5m	4m	6m
Wave period	3.5 – 14s	7.5 – 9.5s	10 – 12s
Wind speed, 1 hour mean	17m/s	12.5m/s	17m/s
Current speed	1m/s	1m/s	1m/s

Length overall:182.85m, Length between perpendiculars 171.6m, Breadth moulded 37.8/47.0m, Depth at side: 19.2m, Operational draught (pipelaying): 8.50m, Operational draught (crane lifting mode):13.50m, Lightship mass: 29,155t, Service speed: 14knots.

Cranes – Hoisting devices used for cargo handling and other operations. Cranes are required to hoist, luff and slew. Separate motors are required for each motion.

Cargo cranes, cargo-handling cranes – Cranes for bulk cargo, containers, general cargo, or palletised cargo.

Construction cranes – Floating cranes for carrying out assembly-work in calm water as well as in unprotected waters.

Deck cranes – Cranes that do not handle cargo: provision cranes, hose handling cranes, etc.

Floating cranes – Usually barge type hulls provided with large cranes used for various heavy lift tasks, salvage and wreck removals. Semi-submersible crane ships are used to carry out offshore installation work.

Gantry crane – A hoisting device, usually on rails, having a lifting hook suspended from a car, which is movable horizontally in a direction transverse to its rails.

Gantry-type hatch cover crane – A deck crane used for handling the **hatch covers** and portable **bulkheads**.

Hose-handling cranes, manifold cranes – Cylinder-luffing cranes used to handle tanker cargo hoses. A hose crane must be explosion-proof. Consequently, hydraulic motors are usually supplied with fluid from a central pump unit located in a risk-free zone.

Monorail provision crane – Rail-mounted trolley that can be moved athwartship and is fitted with rack and pinion drive.

Offshore cranes – A range of shipboard cranes and floating cranes that work offshore, also cranes mounted on offshore installations.

Offshore cranes working on deck – Cranes on offshore installations not used as supply cranes because of their location.

Offshore supply cranes – Cranes located on fixed or floating offshore installations for loading and unloading supply vessels.

Twin cranes – Two cranes mounted on one platform, which can be rotated horizontally through 360°. Each crane can be operated independently, when required the two cranes can be linked together to operate in a twin mode. In this case, both cranes are controlled from the cab of one of them.

Crank – An arm or link connected to a shaft for transferring the motion.

Crank throw – The radial distance from the centre line of a crankshaft to the centre of a crankpin. It is equal to half of the stroke.

Crankcase – The casing which houses the crankshaft and the lower end of the connecting rod.

Crankcase explosion – A crankcase explosion is caused by ignition of oil mist, itself created by the presence of a hot spot, which led to the evaporation of lubricating oil and its condensation into an oil mist. Its consequences can be severe, including death and serious injury to personnel and extensive damage to the engine. Oil mist detection/monitoring equipment is the prime protection for an engine. Should a crankcase explosion occur, the provision of effective explosion relief valves is the main means for mitigating the effects on people and to the engine.

Crankcase explosion relief valve – The crankcase relief valves have two crucial functions: they relieve crankcase pressure and prevent flames from escaping the crankcase.

Crankpin – The pin fitted between the webs of a **crankshaft**. The big end of the **connecting rod** is attached to it.

Crankshaft – A shaft turned by cranks which changes reciprocating motion into circular motion as in internal combustion engines.

Crankshaft deflection measurement – A measurement done by a dial indicator placed at a predefined location between crank webs. The crankshaft is then rotated in one direction and readings are taken at the defined angular locations. Crankshaft deflections should always be taken on an engine at ambient temperature and compared to the baseline measurements.

Crankshaft deflections – Change in distance between crank webs, measured during one rotation of the crankshaft. Crankshaft deflections are an indirect indication of the crankshaft loading condition.



Photo courtesy of Wärtsilä Corporation

Fitting the crankshaft into the bedplate

Crash stop – An emergency manoeuvre of full astern stopping of a ship to avoid a collision.

Crater – A depression in the weld face at the termination of a weld bed.

Crew – The personnel employed on board ship, except for the captain and officers and the passengers.

Crew list – List prepared by the captain showing full names, nationality, passport or discharge book number, rank and age of every officer and crew member on board. This is one of the essential ship documents which is always requested to be presented and handed over to the customs and immigration authorities when they board the vessel on arrival.

Crew negligence – A legal term denoting that damage or an accident is attributable to the ship crew.

Crewboat – Usually fast aluminium craft powered by high-speed diesels, ferrying of crews and light supplies between the shore and rigs and platforms.

Crew/supply vessel, also crew tender – A high-speed boat designed for crew transfer and supply work.

Critical load – The load that brings about a change in behaviour of a structure, such as buckling, yielding, fatigue etc.

Critical structural areas – Locations which have been identified from calculations to require monitoring or from the service history of the subject ship or from similar ships to be sensitive to cracking, buckling or corrosion which would impair the structural integrity of the ship.

Critical temperature – A temperature above which a specific gas can no longer be liquefied.

Cross curves of stability – Cross curves of stability is a set of curves from which the KN values for a set of constant heel-angle values at any particular displacement may be read. Thus, we have a curve for heel angle of 10°, next for 20° and so on. To find KN values for a given displacement volume it is necessary to draw a vertical line and read the values where this line crosses the curves. Nowadays KN values in tabulated forms are used instead of curves.

Cross deck

Cross deck – The area between cargo hatches.

Cross-flooding – Opening a connection between the damaged tank and the tank situated symmetrically on the other side of the ship in order to compensate unsymmetrical flooding. Cross-flooding takes some time and can cause a slow change of the ship position.

Cross-flooding arrangement – An arrangement, which enables to decrease the angle of heel after flooding: when a compartment on one side of a ship is damaged and flooded the corresponding compartment on the opposite side may be flooded.

Cross-joint bolts – Bolts fitted to keep the cross-joint fully closed at sea.

Cross-joint drain channel – A drain or gutter fitted to the cross-joint, which directs any leaked water to the coaming drain.

Cross ties – Horizontal stiffening structures that are fitted in the wing tanks of oil tankers between the side shell and the longitudinal **bulkheads**.

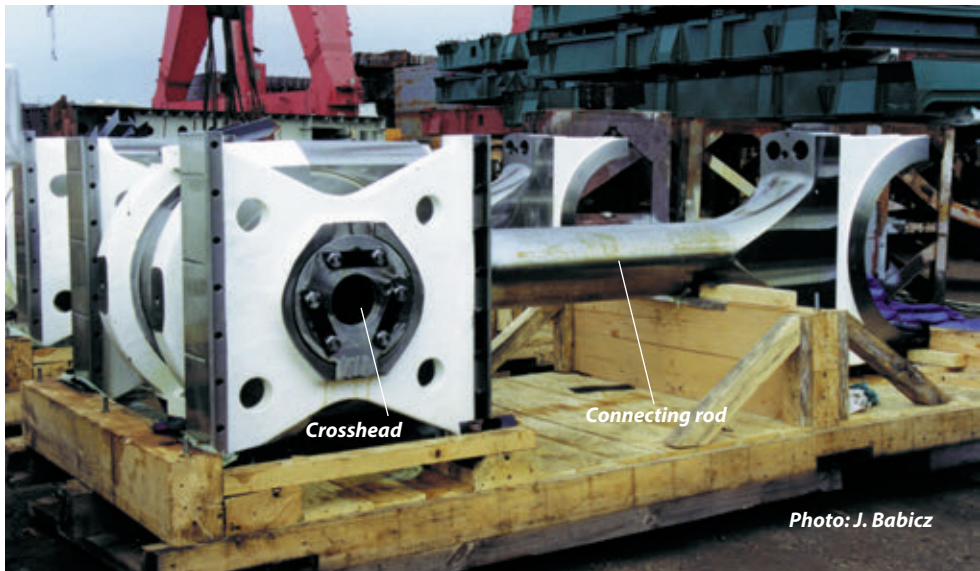

Crosshead – A reciprocating block which usually slides in guides and is the connecting point for **piston rod** and the **connecting rod** in a low-speed, two-stroke diesel engine or for rams and tiller in a **steering gear**.

Crosshead bearing – The crosshead bearing consists of a set of thin-walled steel shells lined with bearing metal.

Crown block – The stationary sheaves mounted at the top of the drilling derrick. The wire ropes attached to the travelling block pass over it.

CRP-Azipod propulsion of the ferries AKASHIA and HAMANASU

According to **Significant Ships** of 2004

The ferries AKASHIA and HAMANASU built by Nagasaki Shipyard (MHI) are the first vessels provided with the CRP-Azipod propulsion. The concept, initially developed by ABB with Samsung for ultra large container vessels, consists of a pod propulsion unit with stainless steel FP propeller, operating behind a single, conventional CP propeller. The two propellers face each other in a single-skeg hull form, and are contra-rotating.

The Kawasaki-designed main propeller is driven mechanically by two 12,600kW Wärtsilä 12V46C main engines, linked through a twin-input/single-output gearbox. Two engines of similar size are also installed to drive the two 12,200kW ABB alternators which provide power for the steerable 17.6MW **Azipod** unit, and for general ship service power. The third Daihatsu/ABB alternator set producing 2760kW is also fitted for auxiliary use.

During sea trials, the vessel achieved the speed of 32 knots. The full-scale comparison between the new vessel and similar twin-screw vessels operating earlier on the same route, demonstrated a 20% fuel saving and striking improvement in exhaust gas emissions. In addition, the pod unit provides exceptional manoeuvrability, especially in port. Operating costs of the new vessels are expected to be further reduced through lower maintenance costs.

Crude oil – Any liquid hydrocarbon mixture occurring naturally in the earth. Properties of crude oil vary considerably depending upon its origin. Crudes generally have a flash point below 26.7° C and a Reid vapour pressure from about 42 to 84 kPa. Crude oils have contaminants such as sulphur and vanadium compounds which encourage corrosion of steel. Crude oils with high and low sulphur contents are referred to as “sour” and “sweet” crude oils respectively.

Heavy crude – Crude oil with a high percentage of heavy oil fractions.

Light crude – Crude oil which contains a high proportion of lighter fractions and is particularly suitable for gasoline production.

Crude oil tanker – An oil tanker engaged in the trade of carrying crude oil.

Crude oil washers – see **washing machines**.

Crude oil washing (COW) – A method of cargo tank washing wherein the **oil** itself is used as the solvent to speed the removal of the residues on the interior surfaces of the tank.

Inerting is always required during crude oil washing.

Cruise ferry COLOR FANTASY

According to **HANSA** 1/2005

The COLOR FANTASY worth over 300 million EUR gave about 1200 man-years of work for Aker Finnyards in Turku, as well as the same number for subcontractors and still more for suppliers of material and components. The contract for building of this vessel was signed on December 16, 2002. The keel was laid on November 25, 2003, and launching took place on April 30, 2004. The first voyage between Oslo and Kiel started on December 10, 2004.

The vessel of just over 75,000GT is close to 224m long and 35m wide and so far the only cruise class liner with 1280m lanes for various kinds of vehicles in two cargo holds with trailer height and one only for passenger cars. Besides, the four car-decks with mainly **crew** accommodation aside and four complete passenger **accommodation** decks, there are decks for entertainment and dining the passengers. All together there are 16 decks. The inside promenade stretches along Deck 7 from the two decks high main restaurant aft to main show-lounge. Deck 7 has an outside promenade and is the evacuation-deck. Rescue boats, marine evacuation systems and rafts are lowered to water from this level. Boats are hanging in davits under Deck 9.

The **superstructure** is divided into five main fire zones being not longer than 40m. The two main vertical connections from Deck 3 through all the decks partly up to Deck 15 are separated fire-zones having the escape staircases and up to eight lift each.



The ship is classified according to two all-new maritime standards: Det Norske Veritas Clean Class, defining environment-friendly design, as well as the Comfort Class, which secures a noiseless and vibration-free environment for passengers.

Passenger accommodation

There are 966 cabins (604 with windows) for maximum 2750 passengers an additional 250 cabins for crew and officers. Passengers cabins vary in size: 10.5m², 13.9m², 24.5m² and 35m² (Five Star Owner Suite). A major feature onboard the vessel is the "Fantasy Promenade" being 160m long, 8m wide and three deck high. It is the longest shopping mall ever seen in any ship. Other places of special interest are the "Observation Lounge" located 40m above waterline and the two-deck high "Tower Night-Club". The onboard attractions also include "Colour Spa" and "Fitness Centre" and pool-area "Aqualand".

There are eight restaurants onboard the vessel: main restaurant is the "Oceanic" stretching over two levels with an attractive aft panorama window. Besides the dining room on Deck 6, there is a fine restaurant located on Deck 7. A "Grand Buffet" self-service restaurant is placed on Deck 6 seating about 700 guests. The main galley can be found on Deck 6. Preparation areas, storing- and cooling rooms are further down on decks 5-2. Further up on Deck 7 there are pantries for delivering food to smaller specialised restaurants and food-stations.

A spacious conference centre with seating capacity for 850 people is arranged on Deck 12. Besides a huge auditorium with raised deck/dome above there are various smaller compartments which can be divided/connected by folding wall systems. There are reception, bar counter areas, boardrooms and gathering areas. There is also a small cinema/lecture room and conference/projection rooms. A pantry and service area cares for the conference participants for food/beverage and business needs.

Photo courtesy of STX Europe



The mega-cruiser liner FREEDOM OF THE SEAS

Cruise liner, cruise vessel – A luxury passenger ship designed to provide holidays afloat.

Cruise liners are now basically designed as a hotel accommodation fitted inside a ship, where public spaces and leisure areas demand larger space.

The vessel uses diesel-electric power system with six Wärtsilä 12V46C main engines split between two rooms to ensure that at least 50% capacity remains available in any machinery failure. Each unit develops 12,600kW at 514rpm and is coupled with an alternator, the combined output of which satisfies all shipboard electrical requirements, including power supply to the three 14,000kW ABB Azipods.

Cruiser stern – A fully radiused stern construction.

CSS Code – Code of Safe Practice for Cargo Stowage and Securing.

Cumulative damage – All damage due to various physical causes, specifically applied to fatigue under various stress ranges and frequencies.

Curing – The hardening of liquid paint by a chemical reaction or by blending a cross-linking agent or **hardener**.

Curing time – Minimum time needed for the paint to achieve its properties and mechanical characteristics.

Current – The flow of electricity through conductor. The unit of measurement is the ampere.

Curve of minimum operational metacentric height GM – During ship design stage many calculations are made in order to define minimum **metacentric height** GM_{MIN} values, which would meet all intact and **damage stability** criteria. Based on these values a set of curves can be prepared for relevant draught range. The limiting envelope curve presents minimum operational metacentric heights which meet all stability criteria for draught range from lightship draught to maximum draught. To obtain accurate guidance for stability of a ship it is enough to calculate the actual metacentric height GM corrected for free surface effects and check whether it is higher or equal to the required GM_{MIN} value.

CONTAINER VESSEL 1200TEU

From "Ship Stability in Practice"

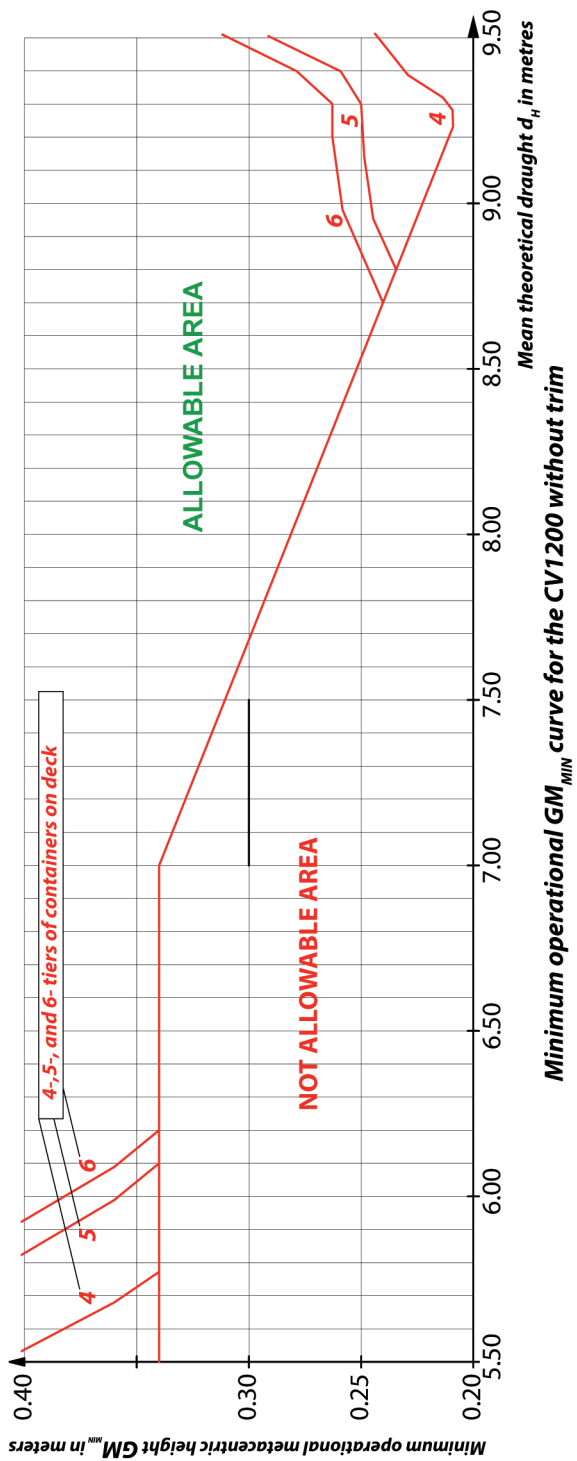

Curve of resistance – A curve showing the resistance of a ship or its model to towing as obtained by experiments in a model basin. The model is run at various speeds and its resistance is shown for each speed. These resistances are plotted as ordinates with the speed as abscissa and the points thus obtained are joined by a curve.

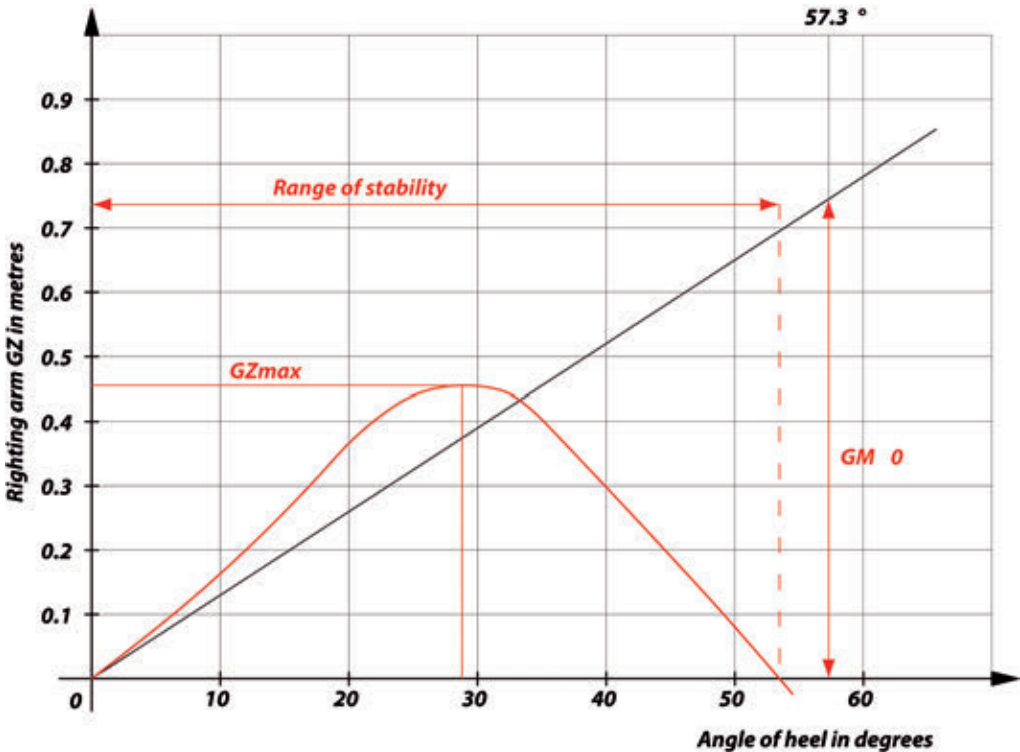

Curve of righting arm GZ, curve of static stability – The plot of the righting arm GZ calculated as function of the heel angle at constant **displacement** and vertical centre of gravity KG.

Curve of sectional areas – A curve whose ordinates are areas of cross sections up to a given waterline corresponding to each point in the length.

Curve of the maximum allowable vertical centre of gravity KG – According to SOLAS, the Master of the ship shall be supplied with reliable information to enable him assessment of the ship stability. Having the curve of the maximum allowable vertical centre of gravity versus draught is enough to calculate actual KG of the vessel and compare the result with the value allowable for a given draught.

Curve of transverse metacentres – A curve showing the height of the transverse metacenter above base line corresponding to any displacement.

Curve of vertical centres of buoyancy – The projection on the plane of inclination of the locus of the centre of buoyancy for varying inclinations with constant displacement.

Curve of weights – Weight per a unit of length of a ship as a function of her length.

Curve of waterplanes areas – A curve indicating the area of water plane corresponding to any draft.

Cutter, cutter head – The dredging industry needs cutters for many kinds of dredging work. The basic cutter skeleton consists of a hub, a ring and several curved arms linking them. On the front side of the cutter arms, the adapters with replaceable teeth or cutting edges are fitted.

Cutter suction dredger d'ARTAGNAN

According to **The Motor Ship** November 2005

The technically advanced self-propeller and ocean-going mega cutter suction dredger d'ARTAGNAN was delivered in October 2005 to the French dredging contractor SDI. The dredger is able to dredge in very hard rocky soils up to a depth of 35 metres thanks to the third generation cutting equipment developed and supplied by the Dutch company of Vosta LMG. A large cutter ladder angle is applied to obtain maximum dredging depth. A large ground reaction force is achieved through the high cutter ladder weight (in excess of 1300 tonnes). The flexibility of the new dredger is considerable and she is capable of discharging at a distance of between few metres (barge loading) to ten kilometres through a 1000mm discharge pipe. To achieve this flexibility, the newbuilding incorporates three dredging pumps: two inboard ones plus a submerged pump in the cutter ladder.

The two main pumps have variable-speed Wärtsilä 12V32 prime movers (2x6000kW or 2x5400kW), and this manufacturer has also supplied the two constant-speed propulsion and alternator-drive engines of 12V32 type, and the twin propeller installation. Each Wärtsilä-Lips CP propeller absorbs 3700kW for a sailing speed of 12.5 knots. A retractable azimuthing thruster is fitted forward to assist manoeuvrability.

D'ARTAGNAN uses completely different **cutter** and suction mouth types. Maximum drive torque and a relatively small cutter diameter are the basis for high cutting forces. The cutter torque, generated by two electrical motors, is passed through a sturdy gearbox. The cutter is driven via the cutter shaft and is screwed onto this shaft. Severe and heavily fluctuating loads act on the cutter shaft thread and, as a consequence, a special Millennium thread design has been selected.

The ship is provided with 11 cutter heads to suit different seabed conditions and materials. The T8 cutter heads, suited to hard rock, are 6- and 7-bladed and so far the strongest cutting system for dredgers ever built. The T8 cutter head has almost the double strength of the strongest cutter heads of the early 90s and is rated as 8,000hp.

In swell, the pontoon can generate considerable forces on the spud, via the spud carriage. These forces decrease when the link between pontoon and spud is flexible. On d'ARTAGNAN, a totally buffered spud carriage has been fitted, which is a new and revolutionary concept based on an exclusive design from VOSTA LMG. A parallel rope guide, which is hydraulically-tensioned, reduces load peaks ensuring that the dredging process is largely independent of the seaway.

Due to the fact that d'ARTAGNAN is designed to work in hard rock, normal dredging anchors are not suitable. Therefore, the two anchor platforms of approximately 250 tonnes each are provided.

Length, oa: 123.80m, Length, bp: 104.40m, Breadth, mld: 25.20m, Depth, mld: 8.20m, Draught design/maximum: 5.50/6.15m, Total power installed: 28,200kW, Propulsion engines: 2 x 6000kW, Dredge pumps: 2 x 6000kW, 1 x 3400kW, Service speed: 12.50 knots.

Cycloidal propulsor, cycloidal propeller – see **Voith-Schneider Propulsor**.

Cylinder – A cylindrical cross-section chamber in which a **piston** moves freely.

CUTTER SUCTION DREDGER D'ARTAGNAN



Photos curtesy IHC Mervede



Cycloidal propulsor

Cylinder block – A metal casting forming part of a reciprocating engine, which contains one or more cylinders.

Cylinder head, cylinder cover – A metal casting which fits over a cylinder.



Photos: J. Babicz

Cylinder head



Cylinder liner

Cylinder liner – A replaceable cylinder which fits into a **cylinder block**.

Cylinder lubricating oil system – Cylinder oil is pumped from Cylinder Oil Storage Tank to the Cylinder Oil Service Tank, placed min. 3000mm above the cylinder lubricators. The cylinder lubricators are mounted on the roller guide housing, and are interconnected with drive shafts. Each **cylinder liner** has a number of lubricating orifices, through which the cylinder oil is introduced into the cylinders via non-return valves.

Damage Control Information (DCI) - The Damage Control Information is a part of onboard documentation. The documentation should be clear and easy to understand. It should not include more information than this directly relevant to damage control, and should be provided in the working language of the ship.

The DCI is intended to provide the ship's officers with clear information on the ship's watertight subdivision and equipment related to maintaining the integrity of the watertight boundaries, so that in the event of ship damage causing flooding proper precautions can be taken to prevent progressive flooding. The DCI should consist of: Damage Control Plan, Damage Control Manual, External Watertight Integrity Plan and Internal Watertight Integrity Plan.

Damage Control Plan – A plan showing clearly for each deck and hold and boundaries of the watertight compartments, the openings therein with the means of closure and position of any control thereof, and the arrangements for the correction of any list due to flooding. The plan is to be permanently exhibited or readily available on the navigation **bridge**. In addition, booklets containing the aforementioned information are to be made available to the officers of the vessel.

Further reading: *MSC.1/Circ.1245 dated 29 October 2007 "Guidelines for Damage Control Plans and Information to the Master"*

Damage Control Manual – The main purpose of this document is to stipulate appropriate action in the case of the hull damage. It should contain the following parts:

1. General Part.
2. Damage Control Plan (in form of a booklet).
3. Damage Survivability Information containing an analysis of different damage scenarios for standard loading conditions.
4. General Instructions for Controlling the Effects of Damage.
5. Associated Documentations (standard plans, diagrams etc).

Further reading: *„Ship Stability in Practice“*

Damage Consequence Diagram (DCD) – A practical method of presenting the impact of damage on the ship's stability developed for passenger vessels by Three Quays Marine Service. The damages are presented by compartments, defined by transverse watertight bulkheads and the illustration presents a quantitative indication of survivability for each case. Compartmental damages are further divided by transverse and vertical extent, namely:

- transversely to either the B/5 line or to the centreline,
- vertical extents covering either baseline upwards or from tank-top upwards.

The results illustrate sequential damage situations for one, two, and three compartments, thus covering scenarios within and in excess of statutory requirements.

To aid interpretation, the damage uses a "traffic light" colour code, with either a red, yellow, or green background, reflecting the severity of the damage. The colour system represents the following results:

- green: 100% of damage stability criteria satisfied
- yellow: 25%-99% of damage stability satisfied
- red: less than 25% of damage stability satisfied.

Damage control team

With DCD a ship staff are able to gain a thorough understanding of their ship survival capabilities, allowing them to prepare their damage control in advance.

Damage control team – A group of crewmembers trained for fighting flooding in the vessel.

Damage penetration zone, damage zone – The zone of the ship where the stipulated damage can be assumed. The stipulated damage is defined in the applicable damage stability requirements.

Damage stability – Stability of a flooded ship. When water runs into a ship following an accident, different scenarios can take place. The ship may sink due to flooding of so many compartments that there is not enough buoyancy to keep the vessel afloat. This was the case for RMS TITANIC that sank in 1912, 2.5 hours after hitting an iceberg. With today's rescue means, 2.5 hours would be enough to save most of the people on board. A much more dangerous scenario is ship capsizing due to loss of transverse stability as this can happen within few minutes. The disasters with HERALD OF FREE ENTERPRISE and ESTONIA may serve as an example. A vessel can survive damage of some extent if the hull is subdivided into watertight compartments by means of watertight **bulkheads**. The subdivision should be designed to make sure that after the flooding of some compartments the ship can float and be stable under moderate environmental conditions. Then, passengers and crew can be saved.

Damage stability calculations – Calculations of stability of damaged ship are complicated and tedious. At present, two different analysis concepts are applied: the deterministic concept and the probabilistic concept. For both concepts, the damage stability calculation shall be made according to the method of lost buoyancy. Unfortunately, the collision resistance is not considered when assessing damage stability and vessels with strengthened side structures are treated in the same way as single-hulled ships. The damage stability legislation is contained in the following Conventions or related mandatory Codes.

CONVENTION OR CODE	TYPE OF SHIP	METHOD
1966 Load Line Convention	Oil Tankers Dry Cargo Ships with reduced freeboard	Deterministic Deterministic
SOLAS 2009	Passenger Ships Dry Cargo Ships	Probabilistic Probabilistic
SOLAS 2009	Bulk Carriers	Deterministic
International Bulk Chemical Code	Chemical Tankers	Deterministic
International Liquefied Gas Carrier Code	Liquefied Gas Carriers	Deterministic
MARPOL 73/78 Annex 1	Oil Tankers	Deterministic

Deterministic concept – This method is based on damage assumptions such as damage length, transverse extent and vertical extent. Depending on the ship type or potential risk to the environment resulting from the type of cargo carried, compliance with a required compartment status must be proved. The deterministic concept applies to chemical and liquefied gas tankers, bulk carriers, offshore supply vessels, high-speed crafts and special-purpose ships.

Probabilistic concept – The new SOLAS 2009 regulations applies for dry cargo ships of 80m in length (L) and upwards and to all passenger vessels with a keel laying date on or after 01.01.2009 respectively for vessels which undergo a major conversion on or after that date. The harmonized regulations on subdivision and damage stability are

contained in SOLAS chapter II –1 in parts B-1 through B-4. These regulations use the probability of survival after damage as a measure of ships' safety in a damaged condition. They are intended to provide ships with a minimum standard of subdivision determined by the required subdivision index R which depends on the ship length and number of passengers. Any assumed damage of arbitrary extent can make a contribution towards establishing of the required subdivision index R. The probability to survive in each case of damage is assessed and the summation of all positive probabilities of survival provides an attained subdivision index A. The attained subdivision index A is to be not less than the required subdivision index R.

Calculations are to be carried out for three initial draughts:

- a deepest subdivision draught without trim,
- a partial subdivision draught without trim,
- a light service draught with a trim level corresponding to that condition.

For each of the three considered draughts the calculated partial index AS, AP and AL shall meet a percentage of the total attained index A. For dry cargo vessels that percentage shall be not less than 0.5R, for passenger vessel 0.9R.

$$A = 0.4 A_S + 0.4A_p + 0.2A_L$$

Damage stability of chemical and product tankers – The behaviour of a damaged chemical carrier can vary widely, depending on the combination of transported chemicals and their specific gravity. If a chemical tanker is loaded with cargo that has a higher specific gravity than water then the damaged tanks lose their cargo and that is replaced by the lighter seawater then the ship will list away from the side that is damaged. However, if the chemicals have a lower specific gravity than seawater then the weight of the water will cause the vessel to list towards the damage.

Further reading: IACS *“Guidelines for Scope of Damage Stability Verification on new oil tankers, chemical tankers and gas carriers”* (No. 110 Nov 2009).

Damage stability requirements for chemical tankers

According to IBC Code a damaged chemical tanker should satisfy the following criteria.

At any stage of flooding:

1. The waterline, taking into account sinkage, heel and trim, should be below the lower edge of any opening through which progressive flooding or downflooding may take place. Such openings should include air pipes and openings which are closed by means of weathertight doors or hatch covers and may exclude those openings closed by means of watertight manhole covers and watertight flush scuttles, small watertight cargo tank hatch covers which maintain the high integrity of the deck, remotely operated watertight sliding doors, and side scuttles of the non-opening type.
2. The maximum angle of heel due to unsymmetrical flooding should not exceed 25°, except that this angle may be increased up to 30° if no deck immersion occurs.
3. The residual stability during intermediate stages of flooding should be to the satisfaction of the Administration. However, it should never be significantly less than that required by the following points 4 and 5.

At final equilibrium after flooding:

4. The righting lever curve should have a minimum range of 20° beyond the position of equilibrium in association with a maximum residual righting lever of the least

Damage Survivability Information (DSI)

0.1m within the 20° range; the area under the curve within this range should not be less than 0.0175mrad. Unprotected openings should not be immersed within this range unless the space concerned is assumed to be flooded. Within this range, the immersion of any of the openings listed in point 1 and other openings capable of being closed weathertight may be permitted.

5. The emergency source of power should be capable of operating.

Damage Survivability Information (DSI) – An analysis of different damage scenarios for standard loading conditions.

In the event of damage to a ship, an assessment of the exact impact of the damage on the vessel's stability is quite difficult. To be able to make correct decisions, while under the extreme stress of an emergency situation, masters shall have an understanding of the survival characteristics of their ships.

Unfortunately the statutory damage stability calculations have very limited value to understand real behavior of the vessel with a particular compartment or group of compartments flooded. In many cases damage scenarios analysed in order to attain a required subdivision index are pure theoretical, far away from real damages. In addition stability characteristics after damage are calculated for worst (minimum) values of GM only assuming empty tanks.

For these reasons it is necessary to analyse different damage scenarios for typical loading cases from the Loading and Stability Manual in order to understand ship's behaviour after flooding and provide masters with a rapid first indication of the implications that damage will have on the ship's stability performance, allowing them to plan their damage control in advance.

Fractures of side shell plating, fractures of side structures, groundings and bow crushings should be investigated.

Contents of a standard DSI carried out by BNC

1. *Introduction*
2. *Ship Particulars*
3. *Precalculated damage scenarios*
 - 3.1 *Penetrations of side shell plating*
 - 3.2 *Strikes by a large vessel*
 - 3.3 *Groundings*
 - 3.4 *Bow crushings*
 - 3.5 *Summary table*
4. *On board computer program for damage stability calculations*
5. *Conclusions*

Damage survey – Occasional surveys which are requested as a result of hull damage or other defects. The damages may result from **grounding**, collision, heavy weather, **contact damage**, etc.

Damage to the environment – Substantial physical damage to human health or to marine life or resources in coastal or inland waters, or areas adjacent thereto, caused by pollution, contamination, fire, explosion or similar disasters.

Damper

1. A hinged flap used to control gas flow, e.g. fire damper in an air trunk.
2. An energy-dissipating device which reduces the amplitude of certain vibration, e.g. axial vibration damper or torsional vibration damper.

Damping – The process, which dissipates the energy of a vibrating system in order to reduce the amplitude of the vibration or oscillation.

Dangerous area – An area on a **tanker**, which, for the purpose of installation and use of electrical equipment, is regarded as dangerous.

Dangerous goods – All substances of an inflammable nature which are liable to spontaneous combustion either in themselves or when stowed next to other substances and, when mixed with air, are liable to generate explosive gases or produce suffocation or poisoning or tainting of foodstuffs.

The **International Maritime Dangerous Goods (IMDG) Code** lists over 3000 hazardous substances. Goods can be categorized as dangerous for any of the following reasons:

- Because they require special care and handling in transit.
 - Because their properties are harmful to human life.
 - Because they possess qualities or create risks that could expose the carrier to liabilities or losses neither acknowledged nor agreed in the contract of carriage.
 - Because they could cause damage to the ship holds or machinery.
 - Because their properties require excessive expenditure by the carrier to guarantee safe transport.
 - Because, if they escape from the ship, they are likely to cause environmental damage.
- The environmental aspect is the most frequently quoted when cargoes are classified as hazardous or noxious.

Dangerous goods classes – Classes of dangerous goods according to SOLAS (Chapter VII, Part A), the BC-Code and the IMDG-Code, are as follows:

CLASS 1 – Explosives

Division 1.1 Substances and articles which have a mass explosion hazard.

Division 1.2 Substances and articles which have a projection hazard but not a mass explosion hazard.

Division 1.3 Substances and articles which have a fire hazard and either a minor blast hazard or a minor projection hazard or both, but not a mass explosion hazard.

Division 1.4 Substances and articles which present no significant hazard.

Subdivision 1.4S *contains substances and articles so packaged, or designed, that any hazardous effects arising from accidental functioning are confined within the package unless the package has been degraded by fire, in which case all blast or projection effects are limited to the extent that they do not significantly hinder fire-fighting or other emergency response efforts in the immediate vicinity of the package.*

Division 1.5 Very insensitive substances which have a mass explosion hazard.

Division 1.6 Extremely insensitive articles which do not have a mass explosion hazard.

CLASS 2 – Gases, compressed, liquefied or dissolved under pressure

Class 2.1 Flammable gases

Class 2.2 Non-flammable, non-toxic gases

Class 2.3 Toxic (poisonous) gases

CLASS 3 – Flammable liquids

Flammable liquids are grouped for packing purposes according to their **flashpoint**, their boiling point, and their viscosity.

Dangerous goods classes

- CLASS 4 – Flammable solids; substances liable to spontaneous combustion; substances which, in contact with water, emit flammable gases**
- Class 4.1** Solids having the properties of being easily ignited by external sources, such as spark and flames, and of being readily combustible, or of being liable to cause or contribute to a fire or cause one through friction.
- Class 4.2** Solids or liquids possessing the common property of being liable spontaneously to heat and to ignite.
- Class 4.3** Substances which, in contact with water, emit flammable gases.
- CLASS 5 – Oxidising substances (agents) and organic peroxides**
- Class 5.1** Substances which, although themselves are not necessarily combustible, but may, either by yielding oxygen or by similar processes, increase the risk and intensity of fire in other materials which they come into contact with.
- Class 5.2** Organic peroxides
- CLASS 6 – Toxic and infectious substances**
- Class 6.1** Toxic substances liable either to cause death or serious injury or to harm health if swallowed or inhaled, or by skin contact.
- Class 6.2** Infectious substances.
- CLASS 7 – Radioactive materials**
- CLASS 8 – Corrosive substances**
- Substances, which, by chemical action, will cause severe damage, when in contact with living tissue or, in case of leakage, will materially damage, or even destroy, other goods or the means of transport. Many substances are sufficiently volatile to emit vapour irritating to the nose and eyes.
- CLASS 9 – Miscellaneous dangerous substances and articles**
- Further reading: International Maritime Dangerous Goods Code.*

Example of dangerous goods intended to be carried onboard the MPV BALTICA

P – Packaged goods permitted

C – Packaged goods in closed freight containers only permitted

A – Packaged and solid bulk goods permitted

B – solid bulk goods permitted

X – NOT PERMITTED

IMO Class	Description	Hold No1	Hold No2	Weather deck
Class 1	Explosives	X	X	C
Division 1.1	Having a mass explosion hazard	X	X	C
Division 1.2	Having a projection hazard	X	X	C
Division 1.3	Having a fire hazard, a minor blast hazard or projection hazard	X	X	C
Division 1.4	Present no significant hazard	X	X	C
Division 1.4S		X	X	C
Division 1.5	Very insensitive substances which have a mass explosion hazard	X	X	C
Division 1.6	Extremely insensitive articles which do not have a mass explosion hazard	X	X	C
Class 2	Gases			
Class 2.1	Flammable gases	X	X	C

Class 2.2	Non-flammable gases	X	X	C
Class 2.3	Poisonous gases	X	X	C
Class 3	Flammable Liquids			
Packing I	Liquids having flashpoint below 18°C	X	X	C
Packing II	Liquids having flashpoint 18°C up to 23°C	X	X	C
Packing III	Liquids having flashpoint above 23°C up to 61°C	X	X	C
Class 4				
Class 4.1	Flammable Solids	A	A	C
Class 4.2 (R1)	Substances liable to spontaneous combustion	A	A	C
Class 4.3 (R2)	Substances which in contact with water emit flammable gases	A	A	C
Class 5.1 (R3)	Oxidizing substances (agents)	A	A	C
Class 5.2	Organic peroxides	X	X	C
Class 6.1	Poisonous (toxic) Substances			
	6.1 Liquids	P	P	C
	6.1 Liquids having flashpoint up to 23°C	P	P	C
	6.1 Liquids having flashpoint above 23°C up to 61°C	P	P	C
	6.1 Solids	A	A	C
Class 6.2	Infectious Substances	X	X	X
Class 7	Radioactive Materials	X	X	X
Class 8	Corrosives			
	8 Liquids	P	P	C
	8 Liquids having flashpoint up to 23°C	P	P	C
	8 Liquids having flashpoint above 23°C up to 61°C	P	P	C
	8 Solids	A	A	C
Class 9 (R3)	Miscellaneous Dangerous Substances	A	A	C

Remarks:

1. Class 4.2 shall include Seed Cake, b) and c), UN 1386 and 2217.
2. Class 4.3 without Aluminium Ferrosilicon, UN 1395, Aluminium Silicon, UN 1398, Ferrosilicon, UN 1408, Zinc Ashes, UN 1435.
3. Class 5.1 shall include Ammonium Nitrate and Ammonium Nitrate Fertilizers.
4. Class 9 shall include Ammonium Nitrate and Ammonium Nitrate Fertilizers.

Dangerous good manifest – A special list of dangerous goods on board and their location.

Danish Institute of Fire and Security Technology (DIFT) – A modern fire laboratory equipped to carry out fire tests according to all European and international standards. More than 1000 fire tests are carried out in the laboratory every year. The DIFT laboratory is able to test items for even the largest cruise ships. There is also a unique facility for carrying out tests of total flooding extinguishing systems.

Data logger – A printer used as a part of a control system to provide a log or record of parameters either on demand or at set intervals.

Datum –

1. A reference point or line from which measurement are made.
2. The most probable position of a search target at a given time.

Daughter boat – A fast support boat designed to be carried aboard a larger vessel. Standard boats are equipped with a special lifting arrangement with a steel frame for safe launch and recovery, and a release hook to fit a davit system.



Photo: J. Babicz

Daughter boat

Davits – Lifting devices for handling lifeboats, rescue boats, liferafts, stores, hoses, etc.

Gravity davits – Davits which slide down and position a lifeboat for lowering as soon as they are released.

Note: Drawings, data sheets and technical specifications of different davit types can be found on www.neddeckmarine.com

Dead cover, deadlight – A hinged, bronze or steel plate serving to protect the glass portlight in heavy weather.

Dead flat –

1. A portion of a ship side or bottom where the plating has no curvature.
2. The midship portion of constant cross section, (the parallel middle body).

Dead ship condition – The condition under which the main propulsion plant, boilers and auxiliaries are not in operation due to the absence of power. Compressed air, starting current from batteries etc. is not available for the recovery of the main power supply, for the restart of the auxiliaries and for the start-up of the propulsion plant. It is, however, assumed that the equipment for start-up of the emergency diesel generator is ready for use.

The ship machinery installations shall be so designed, that they can be brought to operation from dead ship condition.

Dead slow – The lowest speed at which a ship can still be manoeuvred.

Deadlight –

1. A portlight that does not open.
2. A hinged, bronze or steel plate serving to protect the glass portlight in heavy weather.

Deadrise, also raise of floor – The rise or upward slant of the **bottom** of a ship from the **keel** to the **bilge**.

Deadweight (DWT) – The deadweight is the difference between the **displacement** and the mass of empty vessel (lightweight) at any given draught. It is a measure of ship's ability to carry various items: cargo, stores, ballast water, provisions and crew, etc.

SOLAS Convention defines deadweight as follows:

“Deadweight is the difference in tones between the displacement of a ship in water of a specific gravity of 1.025 at the load waterline corresponding to the assigned summer **freeboard** and the lightweight of the ship.”

Note that deadweight thus defined is the maximum deadweight of the ship.

Only in the case of heavy loads put at the bottom of the **hold**, greater deadweight translates automatically into greater amount of cargo. Frequently, a large part of the deadweight is used for water **ballast** necessary to meet **stability** requirements.

Example of wording from BNC Technical Specification of a Panamax container ship: DEADWEIGHT

1. *The guaranteed deadweight of vessel at scantling draught of 13.50m, in seawater with a specific weight of 1.025 T/m³, shall be not lower than 63,200t. The guaranteed deadweight is subject to amendments resulting from the alterations requested by Owners or these introduced in consultation with Owners.*
2. *Deadweight at design draught of 12.00m shall be approximately 51,450t.*
3. *The deadweight is defined as the difference between an actual displacement and the lightship weight. The lightship weight includes the weight of completely outfitted vessel with inventory according to the List of Inventory, spare parts according to the Class Society requirements and with liquids in engine room systems. In particular lightship weight does not include:

 - A. *Loose container lashing equipment.*
 - B. *Spare parts in excess of rule requirements.*
 - C. *Provision stores, crew and effects.*
 - D. *Fuel oil, diesel oil, lubricating oil, fresh water, ballast water in tanks.**

Cargo deadweight, cargo carrying capacity, payload – The number of tons of cargo which a vessel can carry loaded to her summer **freeboard mark**. Contrary to the deadweight, which is constant for a given draught, cargo deadweight depends on type of cargo, masse of stores and ship's stability. Therefore it is not possible to define cargo deadweight just by one figure.

Deadweight scale – A drawing used for estimating the additional **draught** or for determining the extra load that could be taken on board when a vessel is being loaded in water of density less than that of salt water.

Deadwood – The flat, vertical portion of the aft end of a ship.

Deaerator – The efficient operation of water-tube **boilers** requires clean boiler feed, free from gases in solution, (e.g. air, oxygen) at the highest temperature attainable economically. Deaerator is a device which releases the dissolved gases from the feed and simultaneously provides a measure of feed heating.

Decibel – A sound level unit which is one-tenth of a bel. It is used to compare levels of sound.

Deck – A platform in a ship corresponding to a floor in a building. See also **car decks**.

Bulkhead deck – The bulkhead deck is the highest deck to which the watertight **bulkheads** extend and are made effective.

DEADWEIGHT SCALE

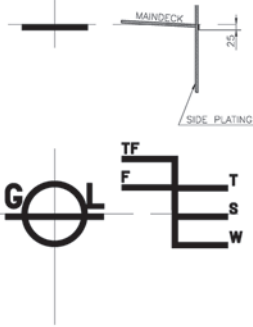

MPV "MEDONEGA"

IMO Register Nr: 9436226

NOTE:
All data refer to the even keel position

LIGHT SHIP = 2893 T

DRAUGHT IN DECIMETRES	DRAUGHT IN FEET	DISPLACEMENT IN TONNES				DEADWEIGHT IN TONNES				TONNES PER 1 CM IMMERSION	TONNES PER 1 INCH IMMERSION	MOMENT TO CHANGE TRIM ONE METER (TONNES-METERS)	METACENTRE HEIGHT (METERS)	DRAUGHT IN DECIMETRES
		IN FRESH WATER ρ=1.025 t/m ³	IN FRESH WATER ρ=1.000 t/m ³ (1)	IN FRESH WATER ρ=1.025 t/m ³	IN FRESH WATER ρ=1.000 t/m ³ (1)	IN FRESH WATER ρ=1.025 t/m ³	IN FRESH WATER ρ=1.000 t/m ³ (1)	IN FRESH WATER ρ=1.025 t/m ³	IN FRESH WATER ρ=1.000 t/m ³ (1)					
65			10000		7000				18.20		16000		65	
64	XXI												64	
63			9500		6500					46.00	15800		63	
62												15600	62	
61	XX		9000		6000				18.00		15400		61	
60										45.50	15200		60	
59			9000		6000				17.80		15000		59	
58	XIX		8500		5500					45.00	14800		58	
57									17.60		14600		57	
56			8500		5500					44.50	14400	7.35	56	
55	XVIII		8000		5000				17.40		14200		55	
54										44.00	14000		54	
53			8000		5000				17.20		13800	7.40	53	
52										43.50	13600		52	
51	XVII		7500		4500				17.00		13400	7.45	51	
50										43.00	13200		50	
49	XVI		7000		4000				16.80		13000	7.50	49	
48										42.50	12800	7.55	48	
47			7000		4000				16.60		12600		47	
46										42.00	12400	7.60	46	
45	XV		6500		3500				16.40		12200	7.65	45	
44										41.50	12000	7.70	44	
43	XIV		6000		3000				16.19		11800	7.75	43	
42										41.00	11600	7.80	42	
41			6000		3000				15.99		11400	7.85	41	
40	XIII		5500		2500					40.50	11200	7.90	40	
39											11000	7.95	39	
38			5500		2500				15.79		10800	8.00	38	
37	XII		5000		2000					40.00	10600	8.05	37	
36											10400	8.10	36	
35			5000		2000				15.59		10200	8.15	35	
34	XI		4500		1500					39.50	10000	8.20	34	
33												8.25	33	
32			4500		1500				15.40		9800	8.30	32	
31	X		4000		1000					39.00	9600	8.35	31	
30											9400	8.40	30	
29			4000		1000				15.20		9200	8.45	29	
28	IX		3500		500					38.50	9000	8.50	28	
27											8800	8.55	27	
26			3500		500				14.80		8600	8.60	26	
25	VIII		3000		0					37.50	8400	8.65	25	
24												8.70	24	
23			3000		0				14.60		8200	8.75	23	
22	VII		2500		0					37.00	8000	8.80	22	
21												8.85	21	
20			2500		0							8.90	20	
19	VI											8.95	19	

MAIN DIMENSIONS

L_{bp} = 112.00 m
 B = 16.50 m
 H = 8.30 m
 d = 6.28 m - moulded

Freeboard deck – The freeboard deck normally is the uppermost continuous deck with permanent means for closing all openings.

Strength deck – The strength deck forms the top of the effective hull girder at any part of its length.

Superstructure deck – A superstructure deck is a deck forming the upper boundary of a superstructure, (ICLL).

Weather deck – Uppermost continuous deck with no overhead protection.

Deck beam – **Athwartship** element of a vessel structure, which supports deck plating and which acts as a strut or tie connecting the vessel sides.

Deck decompression chamber – A unit consisting of two chambers (entry lock and main lock) installed on a support ship. This chamber allows for gas saturation, lodging, recovery and desaturation periods for divers performing a mission in a **diving bell**.

Deck equipment, deck machinery, hull machinery – A term applied to **steering gear**, **capstans**, **windlasses**, winches, and miscellaneous machinery located on the decks of a ship.

Deck gang – The officers and seamen employed in the deck department. Also called deck crew, deck department, or just deck.

Deck girder – A continuous girder running in a fore-and-aft direction on the underside of deck beams.

Deck-hand – Seaman who works on the deck and stays in the **wheelhouse** attending to the orders of the duty officers during navigation and manoeuvring.

Deck log, also called Captain Log – A full nautical record of a ship voyage, noted down at the end of each watch by the deck officer on watch. The principal entries are: courses steered; distance run; compass variations, sea and weather conditions; ship position, principal headlands passed; names of lookouts and any unusual position, and any unusual happenings such as fire, collision, and the like.

Deck officer – It refers to all officers who assist the Master in navigating the vessel when underway, and supervise the handling of cargo when in port.

Deck plating – The plating forming the covering of a deck, considered collectively.

Deck seal – A non-return valve arranged to prevent the back-flow of flammable gases, from cargo tanks, into an **inert gas** plant.

Deck ship – A ship specially intended to carry cargo exclusively on the deck.

Deck stringer – The strake of deck plating that runs along the outboard edge of a deck.

Deck structure – The deck plating with stiffeners, girders and supporting pillars.

Deckhouse – An enclosed erection on or above the weather deck that does not extend from side to side of the ship.

Declaration of security – An agreement reached between a ship and port facility or another ship specifying the security measures to be implemented by both parties.

Decohesion – Breaking within the thickness of a paint film.

Deep pipelaying – Deepwater generally means greater than 500m, whereas very deep water means 1000m or deeper for offshore pipeline installations. In the area of deep pipelaying, the combination of **dynamic positioning** and **J-lay method** is used. In a J-lay method, pipes are laid in a near-vertical position with a specially-designed pipe support tower and a very short stringer. The pipe string is suspended nearly vertical through water depth and bends horizontally in the sagbend strictly adjacent to the seabed. See also **Pipelaying methods**.

Deep-sea trades – The traffic routes of both cargo and passenger vessels which regularly operate on the high seas or on long voyages.

Deepwell cargo pumps – Electrically- or hydraulically-driven cargo pumps used in tanker cargo pumping system. A deepwell pump is submerged in the fluid that it is pumping with its impeller placed in a well in the tanktop, which means that it is only suitable for double-hulled tankers. The advantage is that tank stripping is easier. Each cargo tank has its own pump unit. An electric pump is connected via an intermediate shaft to an explosion-proof electric motor located on the main deck. Hydraulically driven pumps of this type are more popular on chemical tankers. In this option electrically-driven hydraulic power packs need to be fitted. In addition, piping is needed to transmit the hydraulic fluid pressure from the power pack to the pump unit located at the tank.



Deepwell cargo pumps offer a number of improvements, including the elimination of the traditional pumproom, greater pumping and stripping efficiency, more flexible cargo segregation, and corrosion-resistant stainless steel component construction.

Defect of welded joint – A discontinuity or discontinuities that by nature or accumulated effect (for example total crack length) render a part or product unable to meet the minimum applicable acceptance standards or specifications. This term designates rejectability.

Defective weld – A weld with one or more **defects**.

Deformation – Any change of shape or dimensions of a body caused by stresses, thermal expansion or contraction, chemical or metallurgical transformations, or shrinkage and expansions due to moisture change.

WÄRTSILÄ HAMWORTHY DEEPWELL CARGO PUMPS

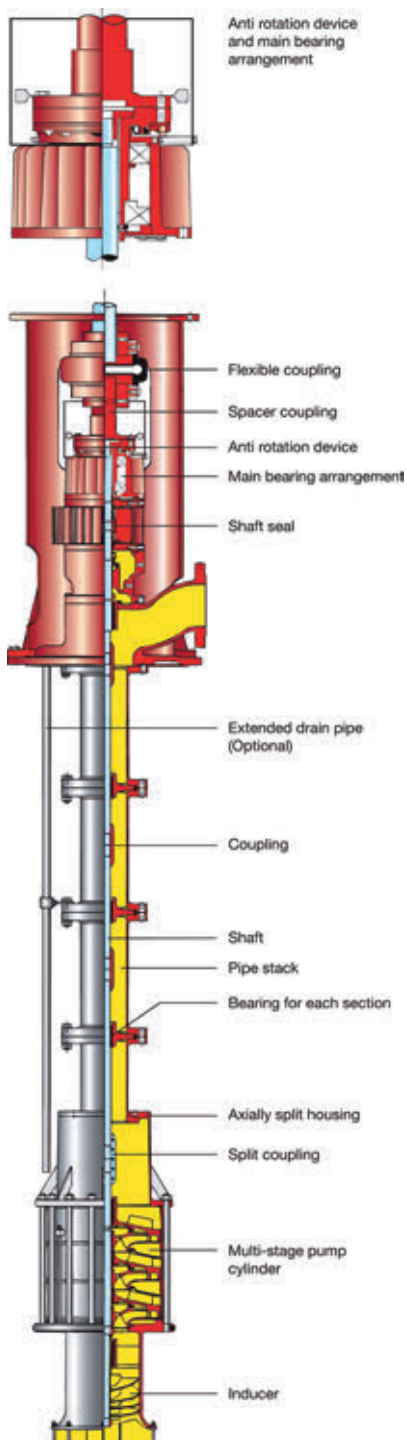

Pump test tower

Photo courtesy of Wärtsilä Corporation

Elastic deformation – Deformations that, after the removal of the external load disappear. The material thus gets back to its previous form and shape.

Plastic deformation – Deformations that, after the removal of the external load are permanent.

Dehumidification – Reducing the humidity. Humidity and condensation can cause damage to cargoes and also to the holds or tanks containing them. Dehumidifying of the areas prevents these problems, and the two most widely used systems employ either refrigeration or desiccant.

In the refrigeration systems the air is cooled, and the amount of water vapour it can hold is reduced, with the excess condensing on the chiller surface. The condensed water has to be either collected into a container or pumped away.

In the desiccant method, a medium (silica gel, for instance) is used to absorb the moisture from air before it is blown into the hold to replace the humid air. Heat is then used to dry the desiccant. The released water vapour is vented outside the controlled atmosphere.

Dehumidifier – A substance or a machine used to reduce humidity in holds or cargo tanks. Calcium chloride and silica gel are water-absorbing chemicals (desiccants) commonly in use.

Delamination – Peeling from undercoat or substrate.

Demersal species – Fish which live at the bottom of the sea, for instance a sole, a hake and a halibut and those which live near the bottom like a cod, a haddock.

Dendamix Marine – A spray-on mineral-fibre insulation material. Using Dendamix Marine as noise or thermal insulation is said to give substantial savings to shipyards, since the adhesive used to spray the fibre directly onto shotblasted and primed steel gives a permanent bond. It precludes any necessity for advanced paint coatings. For A60 steel bulkheads, the material is applied at 45mm thickness over plate and 18mm over stiffeners, at a density of 112kg/m³.

DeNOx – Process of removing nitrogen oxides (NOx) from the exhaust of lean-burn engines, especially by using selective catalytic reduction (SCR).

Density – Mass per volume unit. Expressed in kg/m³ at a specified temperature, normally at 15°C.

Deposit attack – An attack at the edge of a local deposit formed on metal surface in the presence of an electrolyte.

Depth –

Depth moulded – Moulded depth of a ship is measured at the middle of **length L**, from the top of keel to the uppermost continuous deck at side.

Extreme depth – The depth of the ship from the upper deck to the underside of the keel.

Depth of fusion – The distance that fusion penetrates the base metal or previous bead from the surface melted during welding.

Derating – The operation of a diesel engine at normal maximum cylinder pressure for its continuous sea service rating, but at a lower mean effective pressure and shaft speed.

Derelict – Deserted goods or any other commodity, especially a vessel abandoned at sea.

Derrick –

1. A crane consisting of a boom and a mast with a whip and a tackle connected to a deck winch. Derricks may be arranged for fixed outreach working or slewing derricks may be fitted. Most older ships use winches together with derricks for cargo handling.
2. A framework forming a tower over the drilling slot. It is built onto the deck of a drilling rig.

Desalination – The removal of any chemical salts from seawater to produce distilled water. The equipment used may be described as a distiller, an evaporator or a **freshwater generator**.

Desiccant – A substance which can absorb moisture, e.g. anhydrous calcium chloride. It is often used as a drying agent.

Design depth of the underwater unit – The depth in meters (feet) of water equivalent to the maximum pressure which the underwater unit is designed for and approved to operate, measured to the lowest part of the unit.

Design pressure of a piping system – The pressure which each piping system element is designed for.

Design internal pressure of the hyperbaric chamber – The maximum pressure which the hyperbaric chamber is designed for and approved to operate.

Design mission time – The maximum effective recharging interval for life support, compressed air and electrical systems which the underwater vehicle or hyperbaric chamber is designed for and approved to perform the intended function under normal operating conditions.

Design temperature of a piping system – The maximum temperature which each piping component is designed to operate at.

Despatch days – The days saved by loading or discharging quicker than stated in the charter party. The charterer may seek compensation if a provision exists to this effect.

Destination – Port that a vessel is bound for.

Desulphurization – The removal of sulphur and sulphur compounds from gases or petroleum liquids.

Detection – The determination of the location of survivors or survival craft, (**SOLAS**, Chapter III). See also **Lifesaving**.

Devil's claw – A stretching screw with two heavy hooks or claws. It is used to secure an **anchor** in a **hawse pipe**.

Dew point – The temperature below which water vapour in the air condenses.

DF-electric concept, also dual-fuel/diesel-electric propulsion – The propulsion plant developed by Wärtsilä for LNG carriers. It is an electric propulsion with main generators driven by dual-fuel engines that can run on either **boil-off gas** or MDO. The main generators feed the ship electrical system and, through a variable-speed drive system, the propulsion motors. See also **LNG tanker GAZ DE FRANCE ENERGY**.

Diaphragm –

1. A circular plate made up of two halves. It fits between the rotor wheels of a steam turbine and has nozzles in its upper half.
2. A flat or corrugated thin metal plate used in pressure measuring instruments.
3. A piece of flexible synthetic rubber material which forms part of a pressure-tight chamber for a pneumatically operated valve actuator.

Dielectric – A solid, liquid or a gas in which electric field can be maintained with little or no external electrical energy supplied. It is therefore called an **insulator**.

Diesel Combined Cycle (DCC) – Technology utilizing both the shaft output and thermal output of a diesel engine. The thermal output is used to drive a **steam turbine**, for example.

Diesel-electric propulsion – **Electric propulsion** with diesels used as prime movers. Diesel-electric drive takes less space than the equivalent direct-drive two-stroke engine allowing the aft section to be slimmer and giving better flow over the propeller. Not only is the diesel-electric drive train lighter than a two-stroke engine, but also its weight can be distributed more evenly. Also there is no need for auxiliary generators.

Diesel-electric (DE) propulsion emerged early in the 1900s but for most of the century was confined to specialist niches.

A much wider application is now enjoyed thanks to the developments in AC drive technology, the central power station concept for propulsion and ship services, and increasing interest in low emissions and propulsion plant redundancy.

More and more vessels are fitted with electric propulsion plant that have succeeded in **cruise ships, icebreakers, ferries, shuttle tankers, chemical carriers, and research vessels**. The recent Gaz de France LNG tanker project marks another ship type reference for this transmission system.

For offshore vessels it may be selected for flexibility. Where the vessel has to be efficient under numerous operating conditions, it may be that propulsion is only one of several requirements, such as drill ships where the main propulsion system is used in transit, otherwise the power is split between dynamic positioning (DP) and deck power consumption for equipment. Icebreakers are a special case. Here DE propulsion in various forms is a favourite one since it meets the requirements for maximum output at very low speeds. For vessels such as FPSO, the choice of diesel-electric drive is almost automatic, since about 80% of time is spent on production at low power. The remaining time is split between transit, offloading, standby and production at variable loads.

Diesel engine – A type of **internal combustion engine** which ignites fuel by injecting it into hot, high-pressure air in a combustion chamber. It has neither carburettor nor ignition system. The fuel is injected in the form of a very fine spray, by means of a nozzle, into the combustion chamber. There it is ignited by the heat of compressed air which the chamber has been charged with. The diesel engine operates within a fixed sequence of events, which may be achieved either in four or two strokes. The low-speed (i.e. 70 to 120 rev/min) two-stroke diesel is used for main propulsion units, since it can be directly coupled to the propeller and shafting. The medium speed four-stroke engine (250 – 1200 rev/min) is used for the auxiliaries such as alternators and also for main propulsion with a gearbox.

A four-stroke diesel engine resembles a gasoline engine as it works on the four-stroke cycle, that is: admission, compression, power and exhaust. When the piston gets down on the air admission stroke, the lower pressure in the cylinder allows a charge of air into the cylinder through the inlet valve which opens just before top dead centre.

Once the piston has passed the bottom dead centre and is beginning to ascend, the inlet valve closes and the upward movement of the piston compresses the air charge in the cylinder causing a quick rise of temperature. Before the second stroke is over, the charge of fuel oil is gradually injected into the cylinder by an injector.

The burning of the air-fuel charge makes the gases expand. They push the piston downwards and create the power stroke. Before the piston reached the bottom dead centre, the exhaust valve opens and, as the piston goes up again, the burnt gases are forced out through the exhaust valve. Just before top dead centre the inlet valve opens and the cycle begins again.

High-speed diesel engine – Trunk piston type engine having a rated speed of 1400 rpm or above.

Medium-speed diesel engine – Trunk piston type engine with speed range from 400 rpm to 1200 rpm.

Low-speed diesel engine – Crosshead type engine with rated speed of less than 400 rpm.

WÄRTSILÄ LOW-SPEED ENGINES

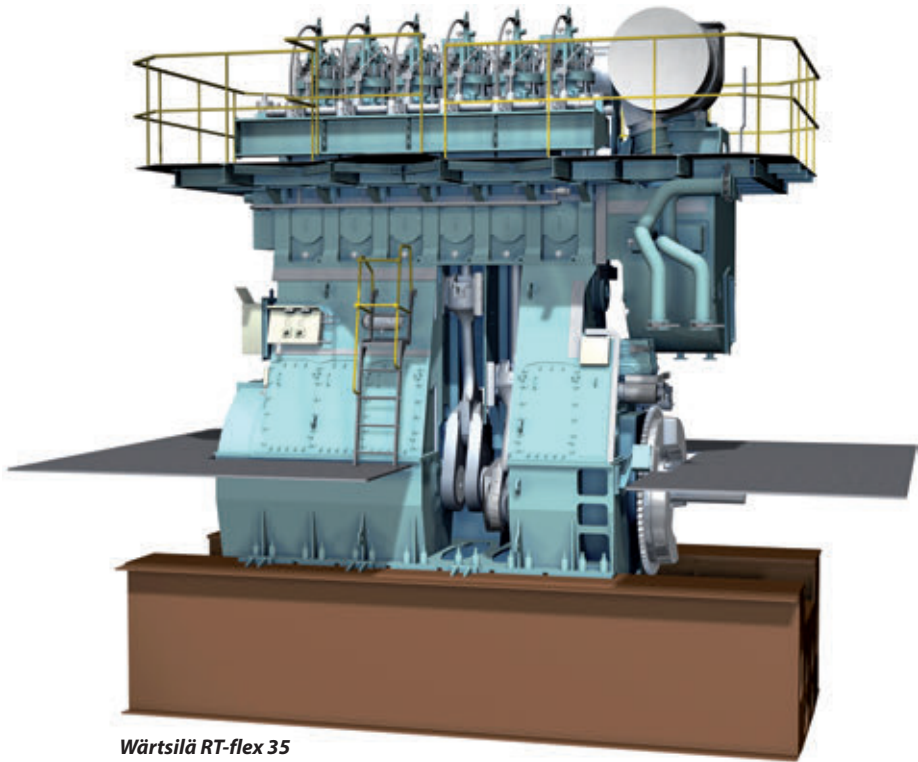

Wärtsilä RT-flex 35



Wärtsilä RT-flex 82T

FOUR STROKE DIESEL ENGINE WÄRTSILÄ 46F

Illustration courtesy of Wärtsilä Corporation

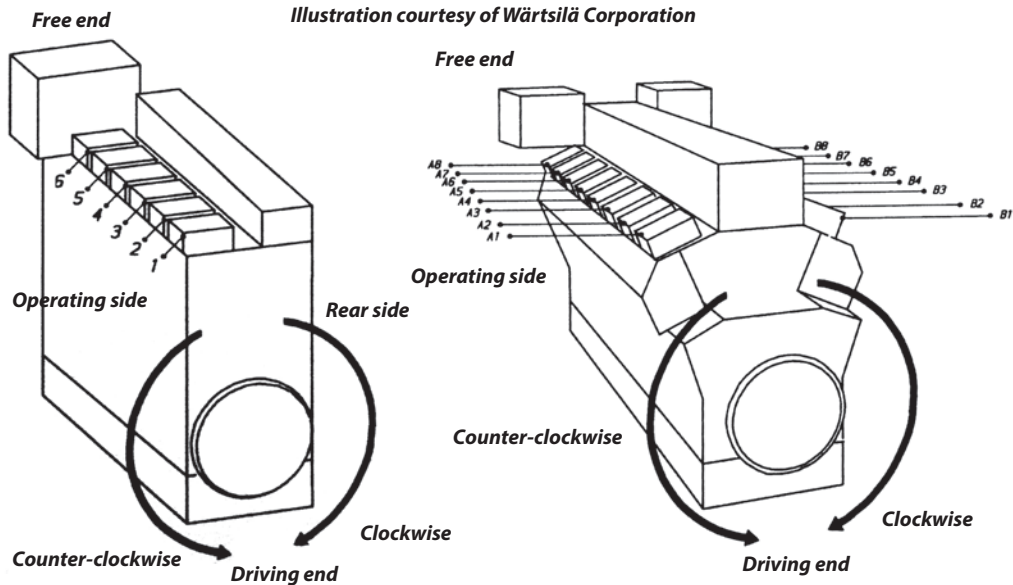

Four stroke in-line diesel engine Wärtsilä 46F

From the Wärtsilä 46 Project Guide:

With a bore of 46cm and a stroke of 58cm, the rated output of the Wärtsilä 46F engine is 1250kW/cyl at 600rpm. Ancillary equipment such as pumps, thermostats and lubrication oil module can be either built on engine or separate. All connections are concentrated at a few points to reduce installation work.

Main components

1. Engine block

The engine block is made of nodular cast iron in one piece for all cylinder numbers. The main bearing caps are fixed from below by two hydraulically tensioned screws. They are guided sideways by the engine block at the top as well as at the bottom. Hydraulically tensioned horizontal side screws support the main bearing caps.

2. Crankshaft

The crankshaft is forged in one piece. Counterweights are fitted on every web. High degree of balancing results in an even and thick oil film for all bearings.

3. Connecting rod

The connecting rod of alloy steel is forged and machined with round sections. The lower end is split horizontally to allow removal of piston and connecting rod through the cylinder liner. All connecting rod bolts are hydraulically tightened. The gudgeon pin bearing is of tri-metal type. Oil is led to the gudgeon pin bearing and to the piston through a bore in the connecting rod.

4. Main bearings and big end bearings

The big end bearings are of tri-metal type with steel back, lead bronze lining and a soft and thick running layer. Both tri-metal and bi-metal bearings are used as main bearings.

5. Cylinder liner

The centrifugally cast cylinder liner has a high and rigid collar to minimise deformations. The liner material is a special grey cast iron alloy developed for excellent wear resistance and high strength. Accurate temperature control is achieved with precisely positioned longitudinal cooling water bores. To eliminate the risk of bore polishing, the liner is equipped with an anti-polishing ring. The cooling water space between block and liner is sealed off by double O-rings. In the upper end the liner is equipped with an anti-polishing ring to eliminate bore polishing and reduce lube oil consumption.

6. Piston and piston rings

The piston is of composite design with nodular cast iron skirt and steel crown. The piston skirt is pressure lubricated, which ensures a controlled oil distribution to the cylinder liner under all operating conditions. Oil is fed to cooling gallery in the piston top through the connecting rod. The piston ring grooves are hardened for good wear resistance. The piston ring set consists of two directional compression rings and one spring-loaded conformable oil scraper ring. All piston rings have a wear resistant chromium plating.

7. Cylinder head

The cylinder head is designed for easy maintenance with only four hydraulically tightened studs. No valve cages are used, which results in very good flow dynamics in the exhaust gas channel. The exhaust valve seats are water cooled and all valves are equipped with valve rotators. The seat faces of the inlet valves are Stellite-plated. In case the engine is specified for MDF operation only, also the exhaust valves are Stellite-plated. Engines that are intended for operation on HFO have Nimonic exhaust valves.

Further information: Project Guide Wärtsilä 46

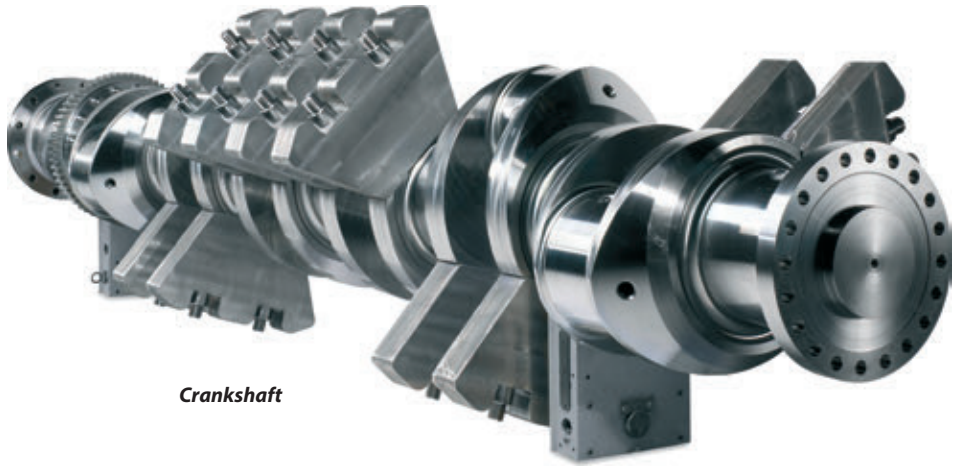

Crankshaft

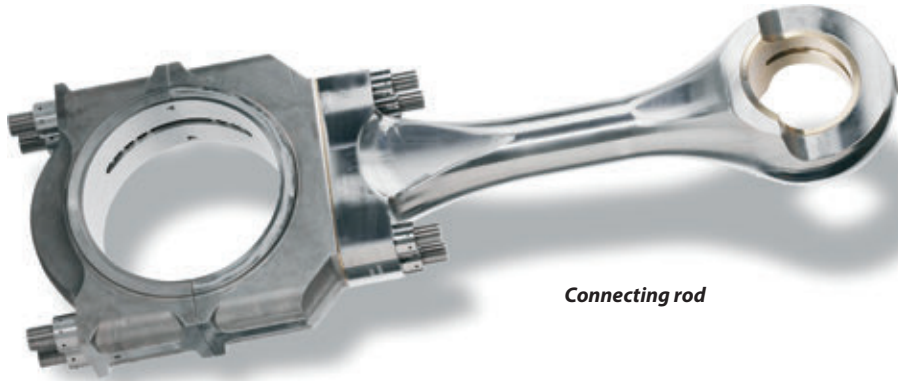

Connecting rod

Photos courtesy of Wärtsilä Corporation



Cylinder liner



Piston

Differential Global Positioning System (DGPS) – An advanced form of GPS navigation which provides greater positioning accuracy than the standard GPS. DGPS relies on error correction transmitted from a GPS receiver placed at a known location. This receiver, called a reference station, calculates the error in the satellite range data and outputs correction for use by mobile GPS receivers in the same locale. DGPS eliminates all the measurement errors in the satellite ranges, enabling a highly precise position calculation.

Diffuser – A chamber, which surrounds the impeller of a centrifugal pump or a compressor, in which some of the kinetic energy of the fluid is converted into pressure energy due to an increasing cross-sectional area of the flow path.

Digital – Referring to data in numerical form.

Digital display – A display in which the measured quantity is given in digital form.

Digital selective calling (DSC) – A technique using digital codes. It enables a radio station to establish contact with, and transfer information to, other stations complying with the relevant recommendations of the International Radio Consultative Committee (CCIR).

Diode – An electronic power component which allows for a flow of current in one direction only; from anode to cathode.

Direct Current (DC) – This is electrical current that does not alternate, the electrons flow through the circuit in one direction. As a result, DC does not generate reactive power. This means that, in a DC system, only real (or active) power is transmitted, making better use of the system's capacity. In order to transmit electrical power as DC, the alternating current generated in the power plant must be converted into DC. At the other end of the process, the DC power must be converted back into AC, and fed into the AC-transmission or distribution network. The transmission of DC current has very low losses. In the conversion between the two forms of power, known as rectification, incurs additional power losses and so it is worth while only when these losses are less than would be incurred by AC transmission, i.e., over very long distances (~1000 km for overhead lines, ~100 km for underwater).

Direct drive – A propulsion system arrangement where the engine is directly coupled to the shaftline. It is usually applied on low-speed engines.

Direct expansion system – A refrigeration system in which the refrigerant expansion occurs due to the direct absorption of heat from the primary medium to be cooled.

Direct Water Injection (DWI) – The method used for reduction of **NOx emissions** by the injection of water directly into the combustion chamber via a separate nozzle: 50-60% NOx reduction with some fuel consumption penalty. The key element in the design concept is the combined injection valve through which both fuel and water are injected. One needle in the combined nozzle is used for water injection, and the other one for fuel injection. Water injection starts before fuel injection in order to cool down the combustion space to ensure low NOx formation before fuel **ignition**. A high pressure water pump is used to generate water pressure of 200 – 400 bar. After filtration and dampening of pressure pulses, the water is fed to the injectors via a pressure regulating valve to provide the correct injection pressure. Water injection timing is electronically controlled and can easily be adjusted from a keyboard. The amount of water injected, i.e. the water/fuel ratio, is controlled by duration of injection. The DWI was an intermediary step used to comply with the Class 1 requirements. Other technologies such as NOx Reducer, exhaust gas recirculation (EGR) and Natural Gas as a marine fuel will need to be utilized in the future to meet the tighter emissions regulatory requirements.

Direct-printing telegraphy – Automated telegraphy techniques which comply with the relevant recommendations of the International Radio Consultative Committee (CCIR), (SOLAS).

Direction of rotation of a propeller – When viewed from astern, if the propeller revolves in a clockwise direction when going ahead, it is known as right-handed. If in an anti-clockwise direction, it is left-handed.

Disabled ship – A damaged or impaired vessel not able proceed by its own.

Disc grinder – Any machine that grinds by the action of a rotating disc.

Discharge – Any release from a ship including any escape, disposal, spilling, leaking, pumping, emitting or emptying.

Discharge book – An essential document for officers and seamen as it serves an official certificate confirming their sea experience in the employment time.

Discharges – Any piping leading through the ship sides for conveying bilge water, cooling water, drains, etc.

Discontinuity – An interruption of the typical structure of a material, such as lack of homogeneity in its mechanical, metallurgical, or physical characteristics. A discontinuity is not necessarily a **defect**.

Discreet Security Alert System – The purpose of this system is to send a covert signal from a ship which will be not obvious to anyone on the ship who is not aware of the alert system. It is of use therefore in circumstances where a ship wishes to inform a person ashore of a problem with a minimum number of persons on board aware of the action. Besides the security alert function the DSAS can also be used to locate the ship throughout the world in a reliable manner.

Disembark – Refers to any time that the crew leave the ship, be it a port call or final destination.

Displacement – It is the weight of water displaced by this vessel at any waterline. It is the product of the volume of its underwater portion and the density of the water in which it floats.

Displacement curve – A curve showing the displacement of a vessel in fresh or salt water at any draft.

Displacement pump – A pump operating by the reduction or increase in volume of a space by mechanical action which physically moves the liquid or gas.

Displacement vessel – A craft that is supported by the buoyancy of the water it displaces.

Displacement water – Water added to the separator bowl to displace the oil and to ensure there is no loss of oil at sludge discharge.

Display – Means by which a device presents visual information to the **navigator**, including conventional instrumentation.

Dissolved gases – Any gas present in water. It may be released when boiled.

Dissolved solids – Any impurities existing in pure water either produced by an evaporator or used as boiler feed water.

Distillate -

1. Product of condensation of freshwater vapour.
2. Any product obtained by distilling petroleum and condensing the vapours.

Distillation – The production of pure water from seawater by evaporation and re-condensing. The main purpose of distillation is to produce water free of salt.

Distortion – The effects of welding on a metal plate. It may appear as shrinkage or an angular twisting. Distortion of steel structures caused by welding and other thermal processes can be assigned to three main causes.

The first is the inherent stresses in the steel received from suppliers. These stresses are a result of heating, rolling and cooling of steel plates in the steel mills. Other causes may include the handling and storage of the plates during shipment to the shipyard and also while in storage prior to production. The inherent stresses may be relieved by cold rolling of the plates, but this may not completely eliminate them. In case of plates below 8mm thickness, cold rolling is not very effective.

The second cause is the distortion directly related to the thermal processes. If the plate is heated quickly, as during cutting or welding, the steel expands. When the plate cools slowly, the cooling causes shrinkage.

The third cause of distortion is an outcome of the management of the overall production process. This includes not only strict adherence to the correct welding procedures, but also the correct alignment of structural parts. Furthermore, it is essential to manage the correction of incipient distortion as it occurs during the assembly.

Distress – A term used when a ship requires immediate assistance.

Distress alert – A radio signal from a distressed automatically directed to a RCC giving position, identification, course and speed of the vessel as well as the nature of distress.

Distress signal – An urgent signal for help assistance.

Distributed load – A load that acts over a part or the whole of the surface of the structure.

Distribution – Electricity supply to various items of equipment, often at different voltages.

Distribution board – A grouping of electrical equipment in a distribution system, which supplies minor items such as lighting. It is supplied from a section board.

Disturbance – Any change inside or outside a control system which disturbs the equilibrium.

Diver – A person who dives, especially one who works under water using a diving-suit.

Diver lock-out compartment – A compartment within an underwater system or vehicle provided with internally pressurizing capability to transfer a diver to the work site from the submersible and back.

Diverter – A type of blowout preventer used on an oil rig to divert fluid safely from well under “kick” or rapid pressure rise condition.

Diving – The offshore industry is heavily dependant on diving operations. Air diving is used for the inspection and repair programmes carried out in shallow waters. For depths of more than 50m saturation diving is necessary. Safe diving operations require sophisticated support systems, such as large pressure chambers to allow the divers to remain under deep water pressure while on board.

Saturation divers live in an onboard accommodation chamber which is pressurised to several times atmospheric pressure for up to a month at a time, traveling to and from their work place at the sea bed in a similarly pressurised **diving bell**. At the end of their time on board they decompress slowly, allowing the absorbed gasses saturated within their tissues by the pressure, to gradually dissipate before exiting the chamber to normal atmosphere. Existing under pressure for extended periods negates the need for prolonged decompression at the end of each dive. This makes deep water diving practical, since it is not necessary to depressurize in between working spells. Diving support vessels are intended as a base for diving operations offshore and are fitted with all equipment necessary for safe deep water diving operations.

Further reading: “Offshore Engineering” by Agnus Mather, www.witherbys.com

Diving bell

Diving bell – A manned, non-self-propelled submersible tethered unit consisting of at least one chamber internally pressurized in order to allow a diver to be transported to and from an underwater site. It is secured to the diving support vessel by a steel cable and an umbilical provides the occupants with breathing gas, heated water, electrical power and communication facilities.

Diving support vessel (DSV) – A vessel provided with **diving equipment** and used for underwater work such as the maintenance and inspection of mobile platforms, pipelines and their connections, well-heads, etc. Today's DSV is a highly sophisticated vessel that may be of mono, multi-hull or semi-submersible construction. The DSV is fitted with a moonpool – a hole in the middle of the vessel open to the sea – through which divers, **remotely-operated vehicles** and other equipment is passed to and from the worksite. These vessels may also have **A-frame** at the stern, used for raising and lowering heavy pieces of equipment, including manned submersibles, into the water. These vessels can maintain an almost exact position over the worksite during these operations. In order to accomplish this, they have fitted with very sophisticated positioning equipment.

Diving Support Vessel SEVEN ATLANTIC

According to Holland Shipbuilding June 2009



Picture courtesy of IHC Merwede

The SEVEN ATLANTIC, delivered by IHC Merwede in 2009 to Subsea 7, is one of the largest and most capable diving support vessels in the world. The 24-person saturation diving system includes four 3-man twin lock living chambers, two 6-man twin lock decompression chambers and two horizontal transfer under pressure chambers (chambers are 2.4m internal diameter). The system is designed to comply with Norwegian NORSOK requirements, and features much improved living conditions compared to previous systems.

The diving system can be divided at the centreline to allow for two crews working at different depths. From their living quarters, on-shift divers can access either of two saturation dive bells through two large transfer-underpressure chambers without disturbing the off-shift divers.

The diving bells have 7m³ internal capacity and are launched through two athwartships **moonpools**, positioned near the minimum motion point of the vessel. A comprehensive system of mechanical handling aids is fitted to support saturation and air diving operations, including port and starboard T bars, A-frames, hose reels, tigger winches and umbilical management hoop booms (20m reach from ship side). Two hyperbaric lifeboats are provided (one port and one starboard).

The divers breathe a helium-oxygen mixture for the entire work shift – up to 2-3 weeks. Below the diving installation is a huge storage area for pressure vessels with helium/oxygen mixture. Some of the oxygen bottles are stored on deck for fire safety reasons. As helium is a costly gas, it is carefully retrieved from the divers' exhaled air and recycled back to storage.

SEVEN ATLANTIC is designed to meet DP3 positioning class, taking into account one failure – including fire and flooding – and will not interfere with the vessel's station keeping, in this particular case supporting diving in weather conditions of 4.5 m significant wave height. This particularly demanding requirement also influenced the decision to opt for three engine rooms with each two diesel-generator sets and three switchboards, located in fire & flooding separated rooms. With regard to the distribution through the main high voltage switchboard, there are vital separations between the generator fields by means of coupled circuit breakers.

The power plant comprises six Wärtsilä 7L32 engines, each driving a 3360kVA Van Kaick generator, generating 6,6 kV (mains voltage). The propulsion installation runs on marine gasoil. It provides power for propulsion, dive systems, crane activities and other consumers.

The entire propulsion/thruster package consists of three Wärtsilä fixed pitch propellers in azimuthing nozzles aft, each driven by an Indar propulsion squirrel cage motor with a shaft power of 2950kW. Each motor is controlled through a custom-designed and built direct water cooled frequency drive. Forward in the ship two electrical retractable Wärtsilä azimuth thrusters are provided, each with a shaft power of 2400kW. Control and power supply are again provided through a similar frequency drive for each thruster. All thrusters are equipped with a propeller nozzle to increase the thrust and to minimize the chance of fouling a wire or umbilical. Additionally, there is a transverse tunnel thruster in the bow with a shaft power of 2200 kW, bringing the total installed propulsion power to an impressive 15,850kW.

The SEVEN ATLANTIC is the first IHC Merwede vessel built under comfort class notation CAC(2). This notation imposes stringent noise levels on the crew quarters. These were achieved by placing the **cabins** in the accommodation block outside the **forecastle** and by adopting floating floors. In addition, a visco-elastic damping treatment is applied to the hull and **bulkheads** in the tunnel **bowthruster** room, which is a major source of noise during DP operations.

Length, oa: 144.79m, Length, bp: 128.96m, Breadth, mld: 26.00m, Depth to main deck: 12.00m, Draught design: 7.00m, Deadweight: 8700dwt, Trial speed: 13.6 knots, Occupants: 150 persons.

Diving system – Compressed air or gas mixture saturation system for the conduct of diving operations. Surface compression chamber, **diving bell**, handling system and fixed gas storage facilities are main components of a saturation diving system.

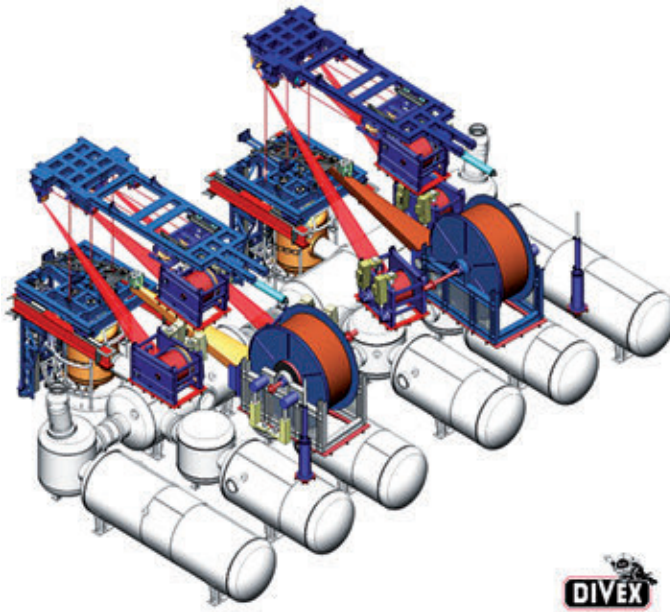

Diving system

Dock –

1. A place where a ship can be moored. A wet dock is a port area isolated from tidal water movements by a lock gate.
2. A place where a ship can be built or repaired. Dry docks can be pumped dry to enable hull repairs and maintenance. They are commonly served by gantry cranes capable of handling units of several hundred tonnes weight.

A floating dock can be ballasted to submerge and receive a floating ship, and then deballasted to bring the ship out of water. It functions as a **dry dock** for ship maintenance while remaining afloat. The main requirement of a floating dock is an adequate depth of water for submerging.

Dock tests – Acceptance tests performed on ship equipment and systems, in the presence of an Owner's supervisor and/or a **class surveyor** to demonstrate suitable performance. Dock tests can start only when installation of equipment and systems subject to testing is totally finished and necessary **tightness tests** carried out. The scope of the dock tests is to be specified in the Dock Test Program that should be prepared by the Shipyard and submitted to Owners approval 2 months before the beginning dock tests. To avoid delay and misunderstanding during tests, the Dock Test Program is to include detailed test procedures prepared according to recommendations and procedures described in maker manuals.

Docking Plan – A plan used by the head of a dry dock to determine the blocking required for a vessel prior to entering the dock.

Docking plugs – Double bottom tanks are provided with plugs to allow draining prior to examination in a **dry dock**. Plugs of water tanks shall differ from plugs for oil tanks.

Docking stresses – Stresses occurring in a ship structure when it is not supported by water, e.g. in a dry or floating dock.

DOCKS

Photo courtesy of VIKING LINE



Dry dock

Photo: J. Babicz



Floating docks

DOCKWISE VANGUARD

DOCKWISE VANGUARD is a semi-submersible vessel for heavy transport and offshore dry-docking built by Hyundai Heavy Industries in Ulsan for the Dutch shipping company Dockwise. The vessel features a bow-less design developed by Dockwise and Deltamarine. It is provided with a free deck space of 275 x 70m, which extends the entire length of the vessel. The design allows the flow of water along the entire deck, but prevents the entry of water into the enclosures of the vessel. A bulwark is also incorporated into the design to ensure the safety of the crew.

The crew accommodation, including the lifeboats section, is on the starboard side of the vessel. The ship is equipped with movable **buoyancy** casings which can be moved to various positions to **accommodate** different kinds of cargo. Machinery exhausts are located in the accommodation deckhouse.

Photo courtesy of Dockwise



The ship was classified with a heavy lift vessel notation and categorised as a 'Type 0' vessel. The **semi-submersible heavy lift ship** can be ballasted down to allow the cargo to be floated aboard. The **ballast tanks** are then de-ballasted to raise the deck over the water surface for lifting its cargo. DOCKWISE VANGUARD can transport large FPSOs, SEMIs, SPARs and TLPs weighing up to 110,000t. The vessel is provided with OCTOPUS-Onboard for the purpose of motion monitoring, response prediction and heavy-weather decision support during heavy cargo transportations.

The DOCKWISE VANGUARD's technical innovation surfaces a completely new offshore service: Offshore Dry-docking. With the significant presence of FPSOs in remote areas often lacking support infrastructure, Offshore Dry-docking service becomes increasingly interesting. The Dockwise Vanguard's FPSO dry-docking service offers inspection, maintenance and repair opportunities (amongst others) at different conditional modes. While dry-docked onboard the vessel's deck, the FPSO remains connected to its mooring and turret system while

keeping the riser systems intact and with the possibility of continuing limited production. Furthermore, the FPSO will still be capable to freely weathervane around the turret mooring.



Drawing courtesy of Dockwise

Offshore dry-docking

Wärtsilä's delivered equipment comprises two 6-cylinder in-line Wärtsilä 38 generating sets (4350kW output), two 12-cylinder Wärtsilä 38 engines in V-configuration (8700kW output) and one 6-cylinder in-line Wärtsilä 20 auxiliary engine (1200kW output). In addition to the engines Wärtsilä supplied the reduction gear system, two controllable-pitch propellers, two retractable thrusters and a bow thruster.

The propulsion system provides a maximum speed of 14 knots. When the vessel is sailing at full speed or in survival mode, all the available power is used. When the vessel is being operated at low speeds, only the smaller engines are needed and the large main gensets can be switched off, reducing the amount of fuel consumed.

Length, oa: 275.0m, Length, bp: 270.0m, Beam, mld: 70.0m, Depth, mld to the main deck: 15.50m, Max Draught: 10.99m, Submerged draught: 31.5m, Water-depth above main deck: 16.00m, Deadweight: 117,000dwt, Output: 26,100kW, Speed max/service: 14/12 knots.

Domestic water – Water that may be used for drinking or cooking.

Doors – Doors should generally open outwards to provide additional security against the impact of the sea. See also **Bow doors**, **Flood control doors**.

Watertight doors – Watertight doors that are used while at sea are to be sliding doors capable of being remotely closed from the **bridge** and are also to be operable locally from each side of bulkhead. Access doors, normally closed at sea may be of hinged-type with gaskets and dogs spaced and designed to ensure watertight closing. These closing appliances are to be provided with means of indicating locally and on the bridge whether they are open or closed.

Double-acting icebreaker FESCO SAKHALIN

An important new stage in the advance of the Finnish double-acting concept has been reached with the handover by Aker Finnyards to the Russian Far Eastern Shipping Co of the combined icebreaker/offshore supply/support ship FESCO SAKHALIN. She has been assigned to support the Exxon/Mobil drilling and production platform Orlan in the Russian Far East. Positioned in only 15m of water, this special gravity platform is subject, in winter, to huge build-ups of ice ridges and ice rubble against the base.



Picture courtesy of STX Europe

Its principal tasks will be to provide an all-year-round safety cover for the drilling platforms on the Sakhalin shelf, as well as transport of dry, liquid and chemical cargoes. The vessel is also able to deal with oil spills and is equipped with a full outfit of skimming and collecting equipment. Operations will be aided by aluminium **workboat** which is lowered into the water by Dreggen crane.

Apart from carrying out these duties she will work as an icebreaker. FESCO SAKHALIN should be able to deal with ice ridges up to 20m deep, also with level ice up to 1.5m, all in temperatures that can fall down to -40° . To meet such difficult conditions, the hull and appropriate machinery are strengthened to the Ice-10 standards of Det Norske Veritas.

Icebreaking capabilities come from a carefully honed aft hull form together with the double-acting principle and a pair of **Azipod** podded propulsion units, each with an output of 6500kW. For each Azipod, there is a hydraulic power unit with two electric motors. One of the electric motors is connected to the main electric network and the other one is connected to the emergency network to guarantee operation and steering even in case of emergency. The primary power is generated by three Wärtsilä 8L38B medium-speed engines, each developing 5800kW and each coupled to a 6847kVA ABB alternator. An additional 6-cylinder 1080kW Wärtsilä 20 engine is provided to power a harbour/emergency generating set.

The vessel is equipped with the latest navigation and communication systems. Transas provided the GMDSS, radio-location system, autopilot, gyro and magnetic compass, echosounder, EDCIS, AIS, GPS as well as vessel intrusion system.

Length, oa: 99.90m, Length, bp: 93.50m, Breadth, mld: 20.95m, Depth, mld: 11m, Draught design: 7.50m, Deadweight maximum: 3,950dwt, Gross tonnage: 6,882, Total power installed: 17,400kW, ice performance: level ice 1.5m, ridges 20m, LSA capacity: 40 persons, rescue capacity 150 evacuees.

Double-acting tankers **TEMPERA** and **MASTERA** for navigating in ice

Two innovative 106,000 dwt **crude carriers** **TEMPERA** and **MASTERA** were built by the Yokosuka shipyard of Sumitomo Heavy Industries Ltd. for the Finnish group Fortum Oil and Gas and they were delivered successfully in August 2002 and January 2003 respectively. The vessels are built according to **Double Acting Technology** and are fitted with diesel-electric podded azimuthing propulsion system.

The first open sea trial of **TEMPERA** was conducted in August 2002 at Sagami Bay of Japan. In addition to normal sea trials, several speed performance tests and maneuvering tests at astern condition were carried out and compared with model tests results. Full-scale ice tests of **MASTERA** were conducted in February 2003 during the voyage between Naantalli, Finland to Primorsk, Russia. Ice experts from Masa-yards Arctic Research Center (MARC) investigated the ice breaking capacity at ballast and fully-loaded conditions.



The principle of the DAT concept is that, like most vessels, it travels ahead on normal open water and thus has a highly hydrodynamic shaped bow and sides. When it sails in ice, however, it travels astern where the reinforced stern hullform is used to break the ice. The podded propulsion system is used to produce a water stream between the ice and the hull, thus lubricating the contact.

The propulsion is provided by an **Azipod** unit. It contains the electric motor and the fixed pitch propeller. This pod can rotate at 360° and has a maximum rating of 16MW, although the nominal output is 15MW. This gives the tanker a speed of 17 knots in open water. In ice, the tanker can go at 3 knots in 1m thick ice. For port manoeuvring purposes, there is also a bow thruster. ABB supplied the complete electric propulsion system.

The hull structure features a reinforced double skin with a fatigue life of 40 years. A double skin cofferdam protects the bunker tanks and there is also a double bottom protecting the pump room.

The tanker has 12 cargo tanks which are divided by a central bulkhead, as well as two slop tanks, which gives it a capacity of 121,158m³ at 98%.

Double Acting Pusher Puller Barge (DAPPB) system

The tanks are filled and drained by four pumps located in the pump room next to the engine room. There are three electrically-driven cargo oil pumps which operate at a rate of 3500m³/h each. There is also a cargo-stripping pump which works at 300m³/h. Amidships houses the cargo manifold system, which contains three manifolds. A 15t crane with a maximum reach of 8m performs hose handling. Offloading takes 12 hours and requires 17t of fuel. Loading takes ten hours and uses 3.5t.

The epoxy-coated ballast water tanks are located in the side and double bottom tanks. There are 12 tanks surrounding the cargo, and these are separated by a longitudinal bulkhead. There are also two fore and two aft peak tanks. These 16 tanks have a total capacity of 46,944m³. It is possible to carry out an emergency cargo transfer into the double hull. Two electric-powered pumps transfer the ballast water. One pumps at 1500m³/h and the other at 3000m³/h.

There are also three tanks that hold drinking water, fresh water and "technical" water. These have a total holding capacity of 324m³.

There is an **inert gas** system for the slop and cargo tanks. The cargo and slop tanks have steam heating coils. Two oil-fired boilers with internal water tubes produce the steam.

Power is supplied by five Wärtsilä diesel gensets. They comprise two 6MW 9L38B diesel engines, and two 4MW 6L38B diesel engines (all of which use heavy fuel oil at a rate of 56t/day when at 13.5 knots). They produce 6.6kA of AC current at 60Hz each. It is then fed into a switchboard and onto the cycloconverter which is linked to the pod motor.

For harbour use there is one 1.7MW 6L26A diesel engine. It runs on MDO stored in a 308m³ tank. There is a 63.2m³ tank for lub oil.

Length, oa: 252.00m, Length, bp: 230.00m, Breadth, mld: 44.00m, Depth, mld: 22.50m, Draught design/maximum: 14.50/15.30m, Deadweight maximum: 106,200dwt, Gross tonnage: 64,259, Total power installed: 22,940kW, Service speed at 15,000kW:15.10 knots.

Double Acting Pusher Puller Barge (DAPPB) system – A new concept of arctic transport based on the principle of a barge being pushed by a dedicated pusher tug in open water and pulled through the ice by specially designed icebreaking tug. The DAPPB system represents an attractive solution for transportation tasks where both open water and ice conditions occur.

Double Acting Technology (DAT) – During winter tests of the Arctic tanker UIKKU, it was found that a ship with an **Azipod** and well designed stern generally performs much better in heavy ice condition when going astern. This conclusion led to the stern-first ice-breaking concept developed by Kvaerner Masa Yard's Arctic Technology Centre (MARC) in order to combine the best of open water performance with superior ice navigation capabilities.

In the DAT design, the vessel has its bow optimised for open water conditions, with stern designed to break the ice. This design is possible only when the **rudder** is replaced with an azimuthing propulsion unit – the Azipod. With this design, the vessel has a performance in open water, which is equal to that of any other vessel and with icebreaking characteristics superior to those of any icebreaker.

Two ice-strengthened, Azipod-equipped supply ships ARTICBORG and ANTARTICBORG delivered for the Caspian Sea service in 1998 were the first newbuildings to implement the double-acting concept. In 2002 and 2003, the concept moved into commercial shipping when two Aframax Arctic tankers TEMPERA and MASTERA were built. The combined icebreaker/offshore supply/support ship FESCO SAKHALIN built by Aker Finnyard in 2005, is the first large example of an icebreaker built according to the double-acting principle.

DOUBLE ACTING PUSHER PULLER BARGE

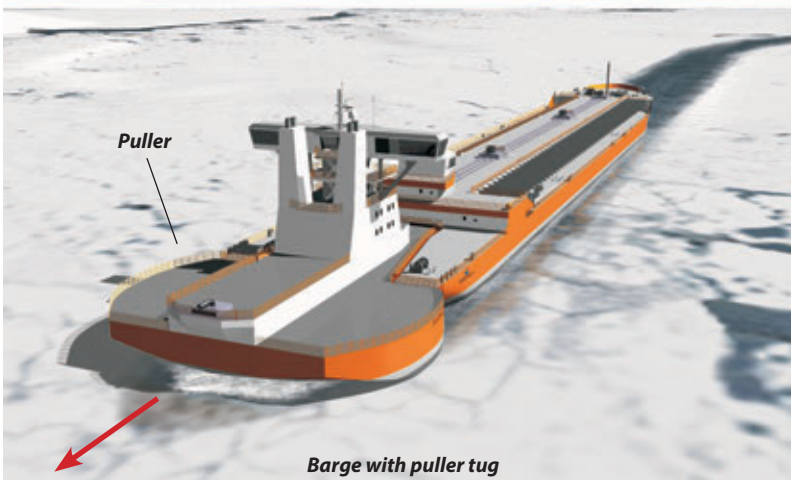
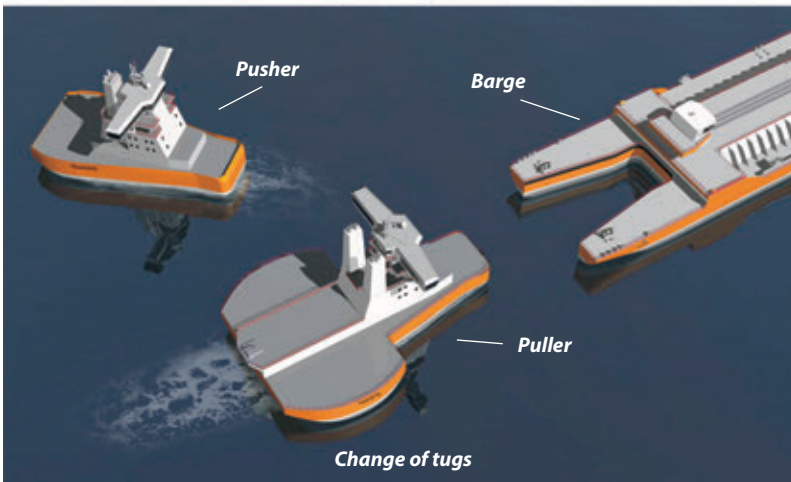
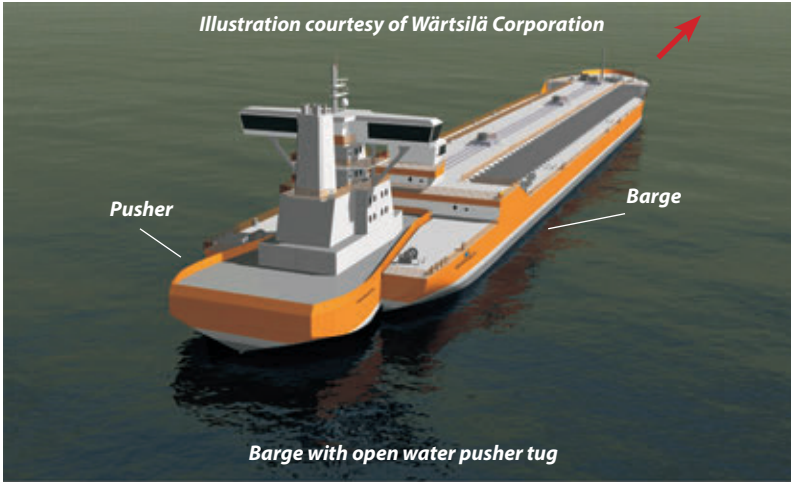



Double-acting container vessel NORILSKIY NICKEL

Further step in DAT concept are two 70 000dwt shuttle tankers that will be built at Admiralty Shipyards in St Petersburg for delivery at the end of 2007 and 2008. Each will have an overall length of 260m, breadth of 34m and draught of 13.6m. The diesel-electric power plant consists of four main diesels providing 25MW total power, split between twin pod drives, each of 8.5MW.

See also **Double-acting tankers TEMPERA and MASTERA for navigating in ice** and **Double-acting icebreaker FESCO SAKHALIN**.

Double bottom – Compartments at the bottom of a ship between the inner bottom and the shell plating. SOLAS 2009 specifies in detail requirements for fitting a double bottom: generally it is to be fitted from the collision bulkhead to the afterpeak bulkhead and shall be continued out to the ship's sides. Under certain circumstances an unusual arrangement could be acceptable.

Further information can be found in Resolution MSC.281(85)

Double bottom structure – The shell plating with stiffeners below the top of the inner bottom and other elements below and including the inner bottom plating.

Double-ended ferry BASTØ III

According to the **Ferry Technology** October 2005

In 2005 the Polish shipyard Remontowa SA delivered a 116m double-ended ferry BASTØ III to the Norwegian owner, Bastø Fosen.

550 passengers are accommodated over one main deck area. The largest lounge can seat 386 passengers in both table and chair and airline-style seating arrangements. It also features facilities including a children play area, dog kennels, toilets, and a bar/food area with the galley located centrally.

FERRY BASTØ III



Photos courtesy of Remontowa Shipyard



Double-ended ferry COASTAL RENAISSANCE

The vessel can carry a total of 212 cars: The ferry car decks are arranged on two levels, with ro-ro outfit being supplied by TTS Ships Equipment. Its delivery to the ferry included: key components for the bow visor aft and forward; the aft and forward ramp cover (4.2mx17m); the aft and forward drop gate (1.5mx12m); and the hydraulic and electrical systems.

Although diesel-electric propulsion with rudderpropellers is commonly adopted for this type of ferry, the BASTO III has a diesel-mechanical/CP propeller propulsion system due to 10% cheaper installation and better fuel economy. Wärtsilä has supplied the complete propulsion package; it comprises two 6-cylinder R32LN engines, each developing 2460kW at 750 rpm and arranged to drive feathering CP propellers via gearing and clutches. Two 3.4m diameter Lips CPS100 propellers are four-bladed, of highly skewed stainless steel designs. Each propeller can be driven by either or both engines, through a crossover shaft connecting the aft engine room with the forward engine room. This arrangement with two separate engine rooms and watertight bulkheads between gearboxes and sterntubes has resulted in the award of DNV's highest redundancy "RPS" notation: at least 50% of propulsive power can be restored after any single failure in the propulsion chain. The 10m² flap rudders and rotary vane steering gears were delivered by Rolls-Royce.

Length, oa: 115.80m, Length, bp: 100.20m, Breadth, mld: 19.00m, Depth to main deck, mld: 6.10m, Depth, mld, at upper deck: 8.95m, Draught, design/scantling: 4.85/5.25m, Deadweight max: 2068dwt, Lightweight: 3105 tonnes, Service speed 80% of power: 16.80 knots.

Double-ended ferry COASTAL RENAISSANCE

According to **Ferry Technology**, December 2007/January 2008

Towards the end of 2007 the first of three new Coastal-class double-enders left Flensburger Schiffbau-Gesellschaft for British Columbia in Canada.

The vessel features a diesel-electric propulsion. Four eight-cylinder medium-speed diesel engines are located in two separate engine rooms. Each engine is connected to a 4800kVA

Photo courtesy of FSG



three-phase synchronous alternator. Together, these generators provide all onboard electrical power and are installed on one common bedplate, which is resiliently mounted to the hull structure. One 11,000kW electric propulsion motor is located at each end of the hull, with the drive to each CP propeller taken through a vertically offset reduction gearbox.

The motors run at constant revolutions (140 rpm) and are run up to nominal speed by means of a soft starter unit. In transit mode only the aft propeller pushes the ship ahead and the forward propeller is feathered, with all four propeller blades at a pitch angle of around 90deg. A speed of 18 knots was sought with just two gensets running and also supplying power for hotel load and ship's services.

COASTAL RENAISSANCE is fitted with two – one located at each end – electro-hydraulic ram type steering gears and two twist-flow full spade rudders. Cargo access equipment has been supplied by MacGREGOR and comprises two pairs of parallel swinging doors on the main vehicle deck and movable railing on the upper vehicle deck.

The two vehicle decks offer a total of 2020 lane metres. The lower deck has a free height of 4.75m and can carry both commercial vehicles such as tractor-trailers, busses and up to 185 North American-sized private cars. The upper vehicle deck has a free height of 2.90m, allowing for the transport of smaller lorries and an additional 185 cars.

The vessel features a number of passenger lounges, a snack bar, two children's play areas, two wheelhouse and crew spaces. In addition, there are open deck spaces on each side of the ship where embarkation points, with a total of four stations for MES equipment and two fast rescue boats, are fitted.

Length, oa: 160.0m, Length, bp: 154.0m, Breadth, mld: 27.6m, Depth, mld, at main deck: 8.09m, Depth, mld, at upper deck: 13.80m, Draught, design: 5.75m, Deadweight at design draught: 2270dwt, Lightweight: 7683tonnes, Passengers: 1650, Vehicles: 370 cars, Diesel generators: 4 x 4000kW, Electric motors: 2 x 11,000kW, Service speed: 21.0knots.

Doubler, doubler plate – A small piece of plate attached to a larger area of plate that requires strengthening in that location. Usually at the attachment point of a stiffener. Also, a flat plate welded to a plated structure that has suffered damage.

Double-skin panel – Hatch cover panel in which both top and bottom surfaces are plated-in.

Downhand – A nonstandard term for **flat welding position**.

Draft survey – Draft surveys are used to determine the weight of bulk cargo such as iron ore, coal, steel scrap, grain and some specific quantities of liquid cargo loaded onto, or discharged from, a vessel.

Draft surveys are convenient and economical means of ascertaining the quantity of cargo loaded or discharged from a ship by reading the vessel's drafts, measuring the ballast water, fuel and diesel oil and other liquids on board, and calculating the final quantity by using the vessel's approved deadweight scales and tank tables, etc.

In principle, draft surveys require only a measurement of the water displaced by the vessel before and after the cargo is transferred, along with a measurement of the water's density. Water displacement is measured through draft marks on the ship and converted to a volume using draft tables. The weight of displaced water is calculated by multiplying its volume (displacement) by its density. The difference between the weights of water displaced before and after the cargo transfer will equal the weight of the cargo within measurement accuracy limits.

Drag

Ideally, while the survey is in progress, the ship should be upright with a trim of not more than one meter by stern and lying still in water, ballast tanks either full (pressed) or empty. Any other conditions give rise to a host of corrections, which increase the probability of errors. In practice, draft surveys are complicated procedures that require a highly qualified draft surveyor.

Further reading: *“Uniform Code of Draught Survey and Equipment Specifications for Determining the Weight of Bulk Coal Cargoes”*

Drag – Resistance (force) caused by friction in the direction opposite to the motion of the centre of gravity of a moving body in a fluid.

Drag coefficient – A non-dimensional coefficient. Its quantity is a measure of the drag force exerted on a body of a particular shape by a fluid it is immersed in.

Drag load – The drag force acting on a particular body moving relative to a fluid within which it is immersed.

Dragging of anchor – Uncontrolled moving of an anchor over the sea bottom because it no longer prevents the movement of the vessel.

Drain, drain line – A pipe used for drainage.

Drainage hole – A hole or opening used for the removal of water from an enclosed volume or surface to avoid flooding of the volume and/or corrosion of the metal surface.

Draining valve – A non-return valve used for drainage purposes.

Draught, also draft – The vertical distance from the moulded base line amidships to the actual waterline.

Air draught -The maximum distance from the water level to the highest point of the ship at the prevailing draught.

Design draught -The draught on which the fundamental design parameters of the ship are based.

Extreme draught – The distance from the **waterline** to the underside of the **keel**.

Moulded draught – The distance from the summer load line to the **base line**, measured at the **midship** section.

Scantling draught – The maximum draught at which the strength requirements for the scantlings of the ship are met.

Draught marks – The number markers on each side of a ship at the bow, stern, and amidships, to indicate the distance from the lower edge of the number to the bottom of the keel or other fixed reference point.



Draught marks amidships

In most cases draught marks cannot be located exactly on fore perpendicular due to shape of the bow. Situation at the stern is even worse and often a lower part of draught marks is located on the rudder and the upper part on the transom. For these reasons draught values as measured on draught marks cannot be used directly to evaluate hydrostatic parameters and must be first recalculated. A procedure how to calculate mean theoretical draught on the base of draughts as measured on draught marks are described on the drawing of Draught Marks.

DREDGING AND DREDGERS

Dredging is a displacement of soil, carried out under water. It serves several different purposes. One of the applications meets the need to maintain minimum depths in canals and harbours by removing mud, sludge, gravel and rocks. Maintenance dredging is now only a basic task, while other fields are growing in demand much faster: creating new land for port and industrial development; trenching, backfilling and protection work for offshore pipelines, coastal outfall pipelines and for cables laid on the sea bed; environmental dredging and clean-up of contaminated sediments; replenishment of beaches and coastlines, not only for coastal protection, but also for recreational uses.

There are two methods of dredging: mechanical excavating and hydraulic excavating. Mechanical excavating is applied to cohesive soils. The dredged material is excavated and removed using mechanical means such as grabs, buckets, cutter heads or scoops. Hydraulic excavating is done with special water jets in cohesionless soils such as silt, sand and gravel. The dredged material which has been loosened from the sea-bed is sucked up and transported further as a mixture (solid material and water) using centrifugal pumps.

Mechanical dredgers

Backhoe dredger – A backhoe dredger is based on the giant land-based backhoe excavator that is mounted at one end of a spud-rigged pontoon. Its main advantage is its ability to dredge a wide range of materials, including debris and soft, weathered or fractured rocks.

Bucket chain dredger – Bucket chain dredge or bucket ladder dredge is a stationary dredger equipped with an endless chain of buckets carried by the ladder. The buckets are attached to a chain and graded according to size (200 to 1000 litres). Bucket dredgers are held in place by anchors. These days, this classic vessel is mainly used on environmental dredging projects.

The bucket chain dredger uses a continuous chain of buckets to scoop material from the bottom and raise it above water. The buckets are inverted as they pass over the top tumbler, causing their contents to be discharged by gravity onto chutes which convey the spoil into barges alongside. Positioning and movements are achieved by means of winches and anchors.

Cutter suction dredger – The cutter suction dredger is a stationary dredger equipped with a cutter head, which excavates the soil before it is sucked up by the flow of the dredge pump. During operation the cutter suction dredger moves around a spud pole by pulling and slacking on the two fore sideline wires. These dredgers are often used to dredge trenches for pipe lines and approach channels in hard soil. Seagoing cutter suction dredgers have their own propulsion. See also **Cutter suction dredger d'ARTAGNAN**.

Grab dredger – A grab dredger employs a grab mounted on cranes or crane beams. Dredged material is loaded into barges that operate independently. Grabs can manage both sludge and hard objects (blocks of stone, wrecks) and this makes them suitable for clearing



up waters that are difficult to access (canals in cities), or for gravel winning and maintenance dredging on uneven beds.

Suction dredgers

Plain suction dredger – A plain suction dredger is a stationary dredger positioned on wires with at least one dredge pump connected to the suction pipe situated in a well in front of a pontoon. The dredged soil is discharged either by pipeline or by barges.

Trailing suction hopper dredger (TSHD) – The trailing suction hopper dredger is non-stationary dredger, which means that it is not anchored by wires or spud but it is dynamically



positioned; the dredger uses its propulsion equipment to proceed over the track. It is a ship-shaped vessel with hopper type cargo holds to store the slurry. At each side of the ship is a suction arm, which consists of a lower and a higher part, connected through cardanic joints. Trailing suction hopper dredgers are used for maintenance work (removal of deposits in approach channels) and dredging of trenches in softer soils.



Photo courtesy of Wärtsilä Corporation

Trailing suction hopper dredger WATERWAY

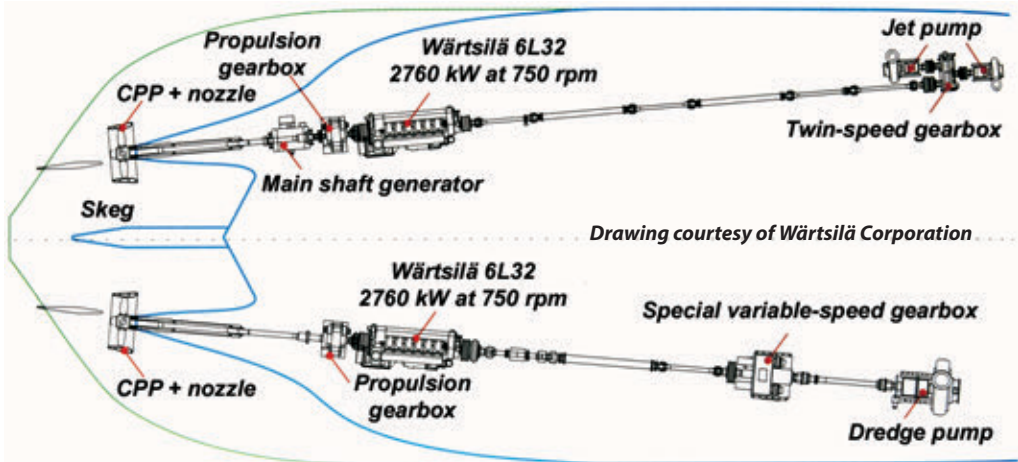

Drawing courtesy of Wärtsilä Corporation

Propulsion plant of the dredge WATERWAY

The dredger is powered by two Wärtsilä 6L32 engines, each of 2760kW MCR output at 750rpm. Each engine drives through reduction gearbox 2500mm diameter CP propeller running at 230 rpm in the nozzle. The maximum power available for propulsion is 2000kW per propeller. The single dredge pump is driven directly off the forward end of the starboard main engine through a clutch coupling, a long shaft and a two-stage variable-speed gearbox. An equivalent arrangement is employed for the twin jet pumps on the port side.

TSHD has several special features, the main one being a drag arm which works as vacuum cleaner. Drag arm consists of a suction bend, lower and upper suction pipes connected via double cardan hinge and a draghead.

The suction bend is mounted in a trunnion which forms part of the sliding piece; as the pipe goes outboard the sliding piece enters the guide on the hull and is lowered until the bend is in line with the suction inlet below the waterline.

The suction pipe can be equipped with an integral submerged dredge pump. Submerged dredge pumps have become more and more popular with operators of larger trailing suction hopper dredges. Locating the dredge pump in the suction pipe positions is much closer to the seabed than a conventional dredge pump housed in the hull.

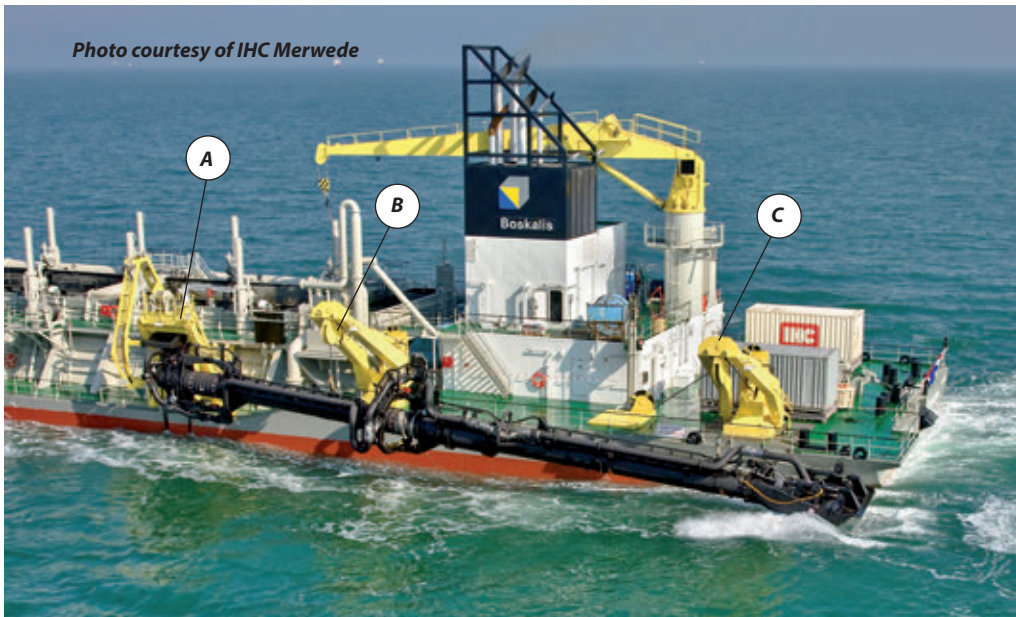

Gantries and drag arm
A – Trunion gantry, B – Intermediate gantry, C – Draghead gantry

The drag arm is hoisted outboard and lowered to dredging depth with the aid of gantries. When not in use, it is lifted above the main deck level and pulled inboard with the hydraulically powered gantries for storage.

Discharge operations, discharge installations

When the vessel has to be discharged, jet pumps are used in the hopper to dilute the spoil so that it can be pumped ashore or discharged on the seabed through bottom doors. Occasionally, accurate placement of the material at great depths is possible via the suction pipes.

Fixed means of transporting dredged soil requires a floating pipeline from ship to shore, a powerful pump and a special link between pipeline and vessel – the bow coupling. Fixed and flexible models are in use. Fixed bow coupling has one degree of freedom (pitch), the flexible one has two degrees of freedom (pitch and turn). The flexible bow coupling can handle difficult sea conditions and reduces loads on the floating pipeline.



Discharge can be made directly into a floating shore delivery pipeline using a ball joint connection over the bow and a discharge pump. A rainbowing nozzle is provided to spray the mixture directly over the bow.

Photo courtesy of Wärtsilä Corporation



The mixture can also be jetted forward over the ship bow via a mixture jetting nozzle (rainbowing).

*See also **Trailing suction hopper dredger VASCO DA GAMA.***

Dredging equipment of UKD BLUEFIN

According to **Significant Ships** of 1997

The dredging equipment features double articulated 700mm diameter trailing suction pipes port and starboard. Each is fitted with a **draghead** having six nozzles fed from a 260mm diameter jet water pipe. The pipes are handled from three gantries with associated hydraulic winches, the draghead gantries having swell compensators, allowing up to 5m of draghead movement. The suction pipes are designed for simultaneous use, with each connected to a 600kW centrifugal **dredge pump** driven from the forward end of the main engines through vertically offset step-down gearboxes and fluid-drive couplings. With both pumps running at 260 rev/min, suction pipes deployed at 50deg and dragheads operating at depth of 28m, the 3915m³ hopper can be filled in 29 minutes via two hydraulically-operated lander doors and the forward fishtail of the central lander. Overboard and light mixture discharges are controlled by a radioactive, density/inductive, velocity transmitter unit in each system.

Dredging spoil is dumped through 10 remotely-operated hydraulic 4m x 2m single bottom doors. Alternatively, it can be pumped out of two suction passages fitted with a total of 10 individually hydraulically-operated doors. The jet water system, degassing, 120 hopper-washdown nozzles and six 100mm manually operated hopper-washdown monitors, are supplied from two 1000 m³/h electric pumps.

Dregging of anchor – Moving of an anchor over the sea bottom to control the movement of the vessel.

Drifting – Floating caused by winds and currents with a determinable direction.

Drill – Thorough practical training and usually with repetitive exercise. Every crewmember shall participate in at least one abandon ship drill and one fire drill every month.

Boat drill – Exercises practised by the crew in swinging out, lowering, and handling lifeboats.

Drill riser – The risers are pipes through which the drill string carries out the drilling function. A marine drilling riser system provides a tubular conduit from the drilling unit to the subsea blow out preventer (BOP) and the wellbore below it. The riser assembly guides down whole tools and equipment from the surface to the wellbore, permits drilling fluids circulate back to the drilling unit, and carries the BOP stack as it is run or retrieved. The drilling riser is composed of a series of joints which are connected by couplings. Choke and kill lines for the BOP are run integrally down the outside of the riser tub along with other auxiliary lines. Typical risers are usually 75ft in length and 30t in weight.

Drill bit – Three rotating cones which are fitted with hardened steel, carbide tipped or diamond edged teeth.

Drill collars – Heavy, thick-walled tubular couplings which connect the **drill bit** to the **drill pipe**.

Drill pipe – The pipe which carries and rotates the drill bit. The drilling fluid passes down the inside of the pipe.

Drill string – The assembly of components used to drill a hole. They are: **drill bit, drill collars, drill pipe, kelly**, saver sub-assembly and swivel.

Drill tender – Ship serving drilling installations, which are on a ship or a barge for storage, accommodation, etc.

Drilling activities:

1. **Exploration drilling** – The search for hydrocarbons by drilling a hole (well) into the seabed to determine reservoir location and estimate its size. See also **Mobile Offshore Drilling Units**.
2. **Production well testing** – It is carried out to measure production rates of flow from an exploratory well and estimate its field life.
3. **Development drilling** – Drilling of a large number of wells through which hydrocarbons flow to a production facility for processing, transportation and sale.
4. **Early production** – The production of hydrocarbons soon after discovery and prior to full development of the production field.
5. **Production** – The process of receiving hydrocarbons from subsea wells, separating out water, oil and gas to make sellable product suitable for export by pipeline or tanker. See also **Offshore Production Units**.
6. **Workover** – A maintenance procedure involving the re-entry of a producing well for the purpose of restoring or improving production.

Drilling barge – A barge equipped for drilling operations in smooth seas. Normally it is not equipped with its own propulsion machinery. Max. drilling depth approximately 150m.

Drilling derrick – A drilling tower with turntable and mudpumping system. It may be installed on an offshore rig or placed on a fixed or floating offshore installation like a **drillship**. A drilling derrick consists of a steel lattice tower which supports the **crow block** and provides temporary storage facilities for drill pipe stands.

Drilling mud, drilling fluid – A liquid consisting essentially of bentonite, colloidal clay dissolved in either water or fuel oil. Baryte is added as a weighting medium to permit variation of the **specific gravity**. Drilling mud lubricates the drill bit, removes drilling debris, stabilises the hole and provides the safety barrier against the ingress of hydrocarbons into the well bore.

Drilling platform – The structure that provides a flat surface above the sea where the drilling rig and other facilities are mounted. A platform may be described as fixed or floating or in terms of its use as exploration, development or production or with respect to the method of construction, e.g. steel, concrete or hybrid.

Drilling rig – The complete assembly of all machinery and the supporting structure from which a well can be drilled.

Drillship – see **MOBILE OFFSHORE DRILLING UNITS**.

Drillship GLOMAR CR LUIGS

We can divide the new drillships designs into three main groups:

1. Ships with no oil storage capability, generally intended for exploration drilling.
2. Ships with a limited oil storage capability (up to about 150,000 bbls) and equipped for exploration and development drilling.
3. Ships with large oil storage (400,000 bbls) and equipped for exploration and development drilling.

The GLOMAR CR LUIGS belongs to the second category. She is built with void spaces designed for oil storage and slop tanks, and can thus be adapted, if needed for extended well testing or early production. The vessel is the smallest of those attempting to combine both drilling and storage functions, and this has complicated design and construction process to a certain extent.

GLOMAR CR LUIGS is a dynamically-positioned monohull drillship, capable of drilling a 35,000ft well in waters up to 3660m depth (12,000 feet). She is delivered initially outfitted for operations

Drive

in 9000ft (2740m) of water. The vessel is marketed as having a variable load capability of 26,000 tonnes while drilling, and 44,000ft² (4088m²) of dedicated equipment storage for tubulars, third party equipment etc. A key feature of the vessel is the attention, which has been paid to the handling of major drilling components, particularly those operations that are affected by the depth of water.

The equipment that has been provided to assist the time consuming elements of deepwater operations includes the following:

- powered riser storage system
 - powered drill pipe and collar racking system
 - powered and stabilised BOP handling system for fully assembled BOPs and subsea trees.
- Conceptually, the vessel design aims to keep the tubular storage (riser, casing, drillpipe) and drilling machinery out of the main hull as far as possible. This means that there is a considerable amount of structure erected above the upper deck to support and contain these items. On the other hand, the interface between the drilling and ship systems is minimised.

Drive - A drive is an electronic device used to regulate the performance of an electric motor.

It works by controlling the power, frequency and current the motor draws from the grid. Drives (also referred to as a variable-speed motor drive) can lead to considerable energy savings as most motors are fixed-speed devices that run at full speed, even when a lower speed would suffice. Many motors are controlled by "throttling down", which is equivalent to slowing a car by using the brake, rather than taking your foot off the accelerator, and does not save energy. Reducing a motor's speed by half using a drive can reduce the energy it consumes to one-eighth of its consumption at full speed.

Dry bulk cargo, solid bulk cargo – Iron ore, phosphate, coal, grain, sugar etc.

Dry bulk shipping – Dry bulk shipping refers to the movement of significant commodities carried in bulk: – the so-called major bulks (such as iron ore, coal, grain), together with ships carrying steel products (coils, plates and rods), lumber or log and other commodities classified as the minor bulks. Other cargo ships include OBO's (ore/bulk/ore carriers or Combination Carriers), which are vessels able to trade alternatively dry and wet cargoes.

The importance of the dry cargo industry is crucial. Without it, global trade and industry could not exist. The international steel industry, for example, could not function without an efficient and cost effective maritime industry transporting the raw materials – coal and iron ore, as well as the means to ship the finished product around the world. At average home, the unseen links with the dry cargo industry are clearly noticed. Toasting a piece of bread involves metal components in the toaster – manufacturing processes using ores and aluminum, grain used in the bread and coal-generated electricity providing the power.

Dry burnable waste – Waste which consists mainly of paper, plastic, wood, fabrics and flowers.

Dry cargo – Cargo other than liquid carried in bulk.

Dry cargo ship – Vessel which carries all merchandise, excluding liquid in bulk.

Dry chemical powder – A flame inhibiting powder used in fire fighting.

Dry film thickness (DFT) – Thickness of the paint film after drying or curing. IMO Resolution MSC.(215)82 defines DFT measurements.

Drying – The type of **environmental control**, similar to **inerting** but the nitrogen must be moisture-free.

Dual activity drilling system – The dual system is capable of drilling two complete wells at the same time. In practice, in an exploration situation, the dual activity capability enables the auxiliary drilling system to be used to drill the top-hole section while the primary system is running the blowout preventer (BOP) and **riser** ready to land on the **wellhead** as soon as the 20in casing is cemented. Consequently the second rotary can be used to pick up and standback tubulars prior to running by the primary system. In a template-drilling situation, the auxiliary rotary can batch set top-hole sections while the primary rig drills the wells to the total depth.

“The DISCOVERER ENTERPRISE drilling package features a single tubular derrick equipped with two rotary tables, two draw-works and two top drives.”

DUAL- FUEL ENGINES FROM WÄRTSILÄ

Dual-fuel engine is the diesel engine that can run on both gaseous and liquid fuels. When running in gas mode, the engine works according to the Otto process where the lean air-fuel mixture is fed to cylinders during the suction stroke. Efficiencies exceeding 47% have been routinely recorded. When running in diesel mode, the engine works according to the Diesel process where the diesel fuel is fed to cylinders at the end of compression stroke. The engine is optimised for running on gaseous fuels and diesel fuel is used for back-up fuel operation.

Wärtsilä began development work with dual-fuel gas engines in 1987, the first concept being the gas-diesel (GD) engine with high-pressure gas injection. This was followed by the second generation of gas engines in the early 1990s, when the company introduced spark-ignited (SG) pure gas engines using low pressure gas. The real breakthrough, however, came when the dual-fuel (DF) engine was introduced by Wärtsilä in 1995. This resulted in the ability to combine fuel flexibility and efficiency with environmental performance.

The DF technology enables the engine to be operated on either natural gas, light fuel oil or HFO. Switching between fuels can take place seamlessly during operation, without loss of power or speed. The engine is designed to have the same output regardless of the fuel used.

The first dual-fuel Wärtsilä 32DF engines for marine application started operating in 2003. They are installed in the world’s first gas-driven PSV VIKING ENERGY and STRIL PIONER.

The first dual-fuel engines of the Wärtsilä 6L50DF type were ordered in 2002 for the world’s first dual-fuel-electric **LNG tanker GAZ DE FRANCE ENERGY**. Next engines were installed onboard of 154,000 m³ dual-fuel-electric LNG carrier GASELYS. She is powered by three 12-cylinder and one 6-cylinder 50DF engines with an aggregate power of 39.9 MW. The four dual-fuel engines drive generators to supply electricity for the two electric motors that drive the single propeller via a twin input/single output reduction gearbox. While making maximum use of the boil-off from LNG cargo to develop useful power, Wärtsilä 50DF engines have much lower fuel consumption overall and thus lower operating costs than the conventional steam turbine plant. Since the first the Wärtsilä 50DF engines were fitted on board LNG carriers about 65% of all new LNG tankers have been fitted with Wärtsilä dual-fuel engines. At the beginning of 2012, the 50DF engine was supplied to the 100th LNG carrier.

In 2013, the Wärtsilä power packs, producing more than 100MW in total, in the new P-63 FPSO vessel have completed full 100% load tests at the Cosco shipyard in Dalian, China.



Picture courtesy of Wärtsilä Corporation

Wärtsilä medium-speed 50DF engine

The FPSO has three separate power generation modules, each comprising two 18-cylinder Wärtsilä 50DF dual-fuel engines, alternators and auxiliary equipment. When in operation at the Papa-Terra oilfield, the modules will supply power to the drilling rig as well as the FPSO itself. The P-63 is said to be the first such ship to use gas engines to produce more than 100MWe of power

The engines are capable of being run on treated well gas or treated crude, as well as marine diesel oil (MDO), which means that virtually no MDO will need to be shipped to the P-63, reducing operating costs. The gas-fired power solution offers significantly lower levels of CO₂ emissions compared to conventional technologies. In real terms, the company estimates that the level of carbon emissions will be reduced by as much as 93,000t/year.

About three years ago, Wärtsilä initiated a major project to adapt its low pressure gas engine technology for use in its two-stroke engine portfolio. Subsequently, a new test engine, the RTX-5, based on a commercially available six-cylinder RT-flex50 engine, was installed in the Trieste engine laboratory in Italy in March 2011. The resulting tests with the low pressure low speed dual-fuel engine have demonstrated that low-speed engine performance can fully comply with IMO Tier III NO_x limits when operating on gas.

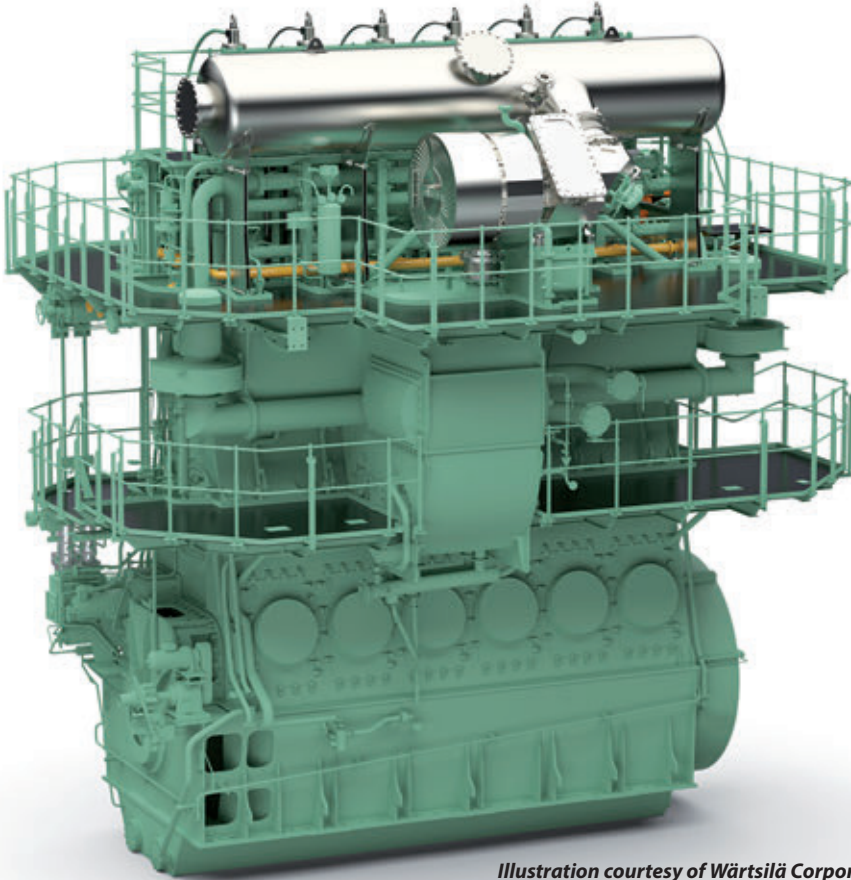

Illustration courtesy of Wärtsilä Corporation

Low-speed low-pressure dual-fuel engine RT-flex 50DF meets IMO Tier III requirements without exhaust gas after-treatment due to lean burn Otto combustion process

Two 15,000dwt tankers under construction for Terntank Rederi Sweden will be provided with 5RT-flex50DF engines with CMCR of 5750kW at 99rpm.

Dual-fuel LNG tanker CORAL ENERGY

According to HANSA International Maritime Journal – 02/2013

Delivered in 2013, the 15,600m³ capacity LNG carrier CORAL ENERGY is the first gas-fuelled ship with mechanical drive to the propeller – previous such installations have all been part of a diesel-electric plant. The ship design has been taken from the eight identical LEG tankers built by Meyer Werft between 2007 and 2010, modified to meet all ice class requirements. And of course, design and construction of the cargo tanks led to a new experience at the Neptun Werft.

The propulsion and machinery and the onboard gas plant are state of the art. The direct mechanical drive via gearbox and controllable pitch propeller is the first application of a medium-speed dual-fuel engine on board a new vessel. To date only Wärtsilä is able to offer dual-fuel engines in the power range between about 1000 and 17,500kW. Thus for both main propulsion and generator drive, Wärtsilä engines had been chosen. The eight-cylinder main

engine of the 50DF series has an output of 7800kW at a speed of 514rpm. The best specific fuel consumption in the gas mode is 7300 kJ/kWh and the amount of pilot diesel oil at MCR only 2.4 g/kWh.



There are two six-cylinder auxiliary engines of the 20DF series with an output of 1056kW each driving the generators. The pilot fuel consumption of these engines is with only 1.0 g/kWh at full load even better than that of the main engine. With the power of 7800 kW the vessel reaches a maximal service speed of 15.8 kn at maximal 4 Bft in gas and diesel mode. To avoid or at least minimize the problems of engine knocking in the Otto mode during acceleration of the vessel she is equipped with a CP propeller type Wärtsilä 4E 1415 D with a diameter of 5400 mm. The engine torque is transmitted to the propeller via a gearbox from Renk. The bow thruster installed was supplied by Verhaar type OFP 1800 with a power input of 850 kW.

Equipment and accommodation

The vessel is equipped with two hydraulically driven windlasses from Rolls-Royce and 4200kg self-balancing anchors. The mooring equipment was as well supplied by Rolls-Royce. There are seven hydraulically driven winches, all with two drums. The hose handling crane has a heeling force of 5t at an outreach of 18.5m and the provision crane of 4t at 8.3m. The lifeboat is of the free-fall type with a capacity for 30 persons. In addition, there is a rescue boat for six persons. The total of 25 cabins with 26 berths is divided in two captain class cabins, six officer class cabins, 15 crew class cabins, one double berth class cabin and one owner respectively pilot class cabin.

Cargo tanks and pumps

The total cargo capacity of CORAL ENERGY of 15,600 m³ is split into three independent type C horizontal bi-lobe tanks below deck. The maximal tank pressure is 4.20 bar and the minimal temperature -163°C. The walls of the tanks are made of a special shipbuilding nickel steel

with a nickel content of 9%. This is a steel alloy with high low-temperature toughness known as NV 9Ni. The tanks including the necessary insulation have been built at the yard in Rostock. Depending on the efficiency of insulation, the surface area as well as the outer temperature, the boil-off rate is in the range between 0.1 and 0.15% of maximal filling per day on large carriers, according to TGE Marine in Bonn. Small tankers have a »bad surface to volume ratio resulting in high boil-off rates in the order of 0.2 to 0.6% per day. This is the reason why such vessels should be equipped with Otto gas engines or dual-fuel engines for both propulsion and power generation. The gas equipment for loading and unloading as well as the handling equipment for boil-off gas and the fuel gas supply system has been developed by TGE. There are six cargo pumps type Wärtsilä Hamworthy Deepwell with a feed rate of 270 m³/h LNG with a maximal specific weight of 0.50 t/m³ at -163°C. Thus, the maximum loading rate with vapor return line is 1620 m³/h. Loading without vapor return line is impossible. The maximal discharge rate is the same. For fuel gas supply there is a vaporizer to heat up the gas. The inert gas plant is of a membrane type with a capacity of 80 Nm³/h with a composition of 97 volume % N₂ and a minimal temperature of -40 °C.

Length overall:154.95m, Length bp:146.67m Breadth moulded 22.70m, Depth moulded: 14.95m, Summer draught: 8.45m, Deadweight: 12,259dwt, Gross tonnage: 13,500, Service speed: 15.8kn.

Ductility – The ability of a material to undergo permanent change in shape without rupture or loss of strength.

Dumb panel – The non-wheeled panel in a stacking hatch cover system.

Dunnage – Timber boards which are laid under cargo parcels to keep the surface of the cargo off steel deck plate. Its purpose is to provide air space around the cargo and so prevent “cargo sweat”.

Dust – Loose particle matter present on a surface prepared for painting, arising from blast-cleaning or other surface preparation processes, or resulting from the action of the environment.

Duty engineer – The engineer responsible for machinery and equipment operation during unattended machinery space operation.

Dye penetrant – A liquid penetrant used to obtain an outline of fractures within the metal surface. To perform the test, a thin oil-like liquid containing a dye is applied by a brush, flow, or dip method; the liquid moves into small openings or cracks during a penetration time (1-30min). After the excess liquid on the surface is carefully removed and the object is dried, a developer is applied to the surface. This material is typically a fine powder, such as talc, usually in suspension in a liquid. It acts like a blotter and pulls the liquid penetrant out of surface imperfections. The liquid tends to spread in the developer, enlarging the indication.

Dye penetrant testing – A non-destructive test applied to metal items to detect surface cracks. A penetrant liquid is applied and is then detected in cracks by the use of a developer.

Dynamic load – A load that produces significant acceleration of a body.

Dynamic positioning – A seagoing vessel is subject to forces from wind, waves and currents as well as from forces generated by the propulsion system. Dynamic positioning is a capability of a vessel to maintain its position automatically using its propulsion system. In the offshore industry DP is used on diving support vessels, pipelay vessels, shuttle tankers, platform supply vessels etc. The DP system is a complete installation necessary

for dynamically positioning of a vessel, including the vessel's power system, thruster system and the DP control system.

Further reading: *ABS Guide for Dynamic Positioning Systems*

Dynamic positioning system – A hydrodynamic system which controls or maintains the position and heading of the vessel by centralized manual control or by automatic response to the variations of the environmental conditions within the specified limits.

DP system comprises the sub-systems:

- **power system,**
- **thruster system,** and
- DP-control system.

DP systems are divided into three classes:

DP1 has no redundancy. Loss of position may occur in the event of a single fault.

DP2 has redundancy so that no single fault in an active system will cause the system to fail. Loss of position should not occur from a single fault of an active component or system such as generators, thruster, switchboards, remote controlled valves etc., but may occur after failure of a static component such as cables, pipes, manual valves etc.

DP 3 also has to withstand fire or flood in any single compartment without affecting the system. Loss of position should not occur from any single failure including a completely burnt fire sub division or flooded watertight compartment.

Further reading: *IMCA Guidelines for The Design and Operation of Dynamically Positioned Vessels, ABS Guide for Dynamic Positioning Systems*

Dynamical stability – The dynamical stability of a ship at any inclination is defined as the work done in heeling the vessel to that inclination.

Dynamically-positioned vessel – A vessel which automatically maintains its position (fixed location or predetermine track) exclusively by the action of its **thrusters**.

Dynamically-supported craft (DSC) – A craft that is operable on or above water and which has characteristics different from those of conventional displacement ships.

A craft, which complies with either of the following characteristics would be considered a DSC:

1. if weight, or a significant part thereof, is balanced in one mode of operation by other than hydrostatic forces;
2. if the craft is able to operate at speeds such that the **Froude number** is equal to or greater than 0.9.

Earthing – The electric connection of equipment to the main body of the earth to ensure that it is at earth potential. On board the ship, the connection is made to the main metallic structure of the ship, which is at earth potential because of the conductivity of the sea.

EC directive on marine equipment (European Union Marine Equipment Directive) – The directive of European Commission about marine equipment for which international conventions require the approval of the national administrations as well as mandatory carriage on board. That means items like life-saving appliances, evacuation systems, fire fighting and prevention, navigation equipment, communications, but also some pollution prevention equipment like oily-water systems, sewage and incinerators. Only equipment proven to comply with the requirements of relevant international instruments is allowed on board of an EU ship.

ECDIS – see **electronic chart display and information system**.

Edge grinding – The treatment of the edge before secondary surface preparation.

Edge preparation – The shaping of a plate edge for welding. This may take the form of a V, X, Y, or K edge profile.

Edible oil tanker – A tanker designed for the carriage of **edible oils** for food industry.

The STAR BONAIRE is a sea/river tanker suitable for the carriage of all kind of edible oils. The cargo tank section features a total number of 14 stainless cylindrical cargo tanks, all vertically mounted. To use the hold volume optimally the tanks are of three different diameters, viz. 9.60m, 4.65m and 3.80m. All tanks have a height of 7m and are supported by flexible elements. When all tanks are filled up to 95%, 2500t of edible oils can be carried.

Edible oils – Cocoa butter, coconut oil, palm oil, peanut oil, rape oil, soya bean oil, sunflower oil. Most of edible oils have a specific gravity of 0.89t/m³.

Effective clearing of the ship – The ability of the **free-fall lifeboat** to move away from the ship after free-fall launching without using its engine.

Efficiency – The ratio of output to input for a system or operation. It is usually expressed as a percentage.

Efficiency Rudder – A patented semi-balanced **rudder** developed by Wärtsilä Corporation. The Efficiency Rudder is characterised by a streamlined “torpedo”-shaped bulb on the **rudder horn** immediately abaft and coaxial with the **propeller hub**. The bulb ensures a more homogeneous water **flow** both in front of the **propeller** and in the propeller slipstream. The bulb increases propulsion efficiency by the “wake gain” effect, which means that it reduces the water speed into the propeller so that less power is needed to produce the same propeller thrust. The bulb also reduces propeller-induced hull noise and vibration by eliminating hub vortices and separation, and **cavitation** behind the propeller hub collapsing on the propeller. Single-screw vessels equipped with the Efficiency Rudder have 5-7% improved propulsive efficiency, pressure impulses are reduced by 30-45%. See also **Energopac**.

EIAPP statement of compliance – When testing the engine for **NOx** emissions, the reference fuel is Marine Diesel Oil (Distillate) and the test is performed according to

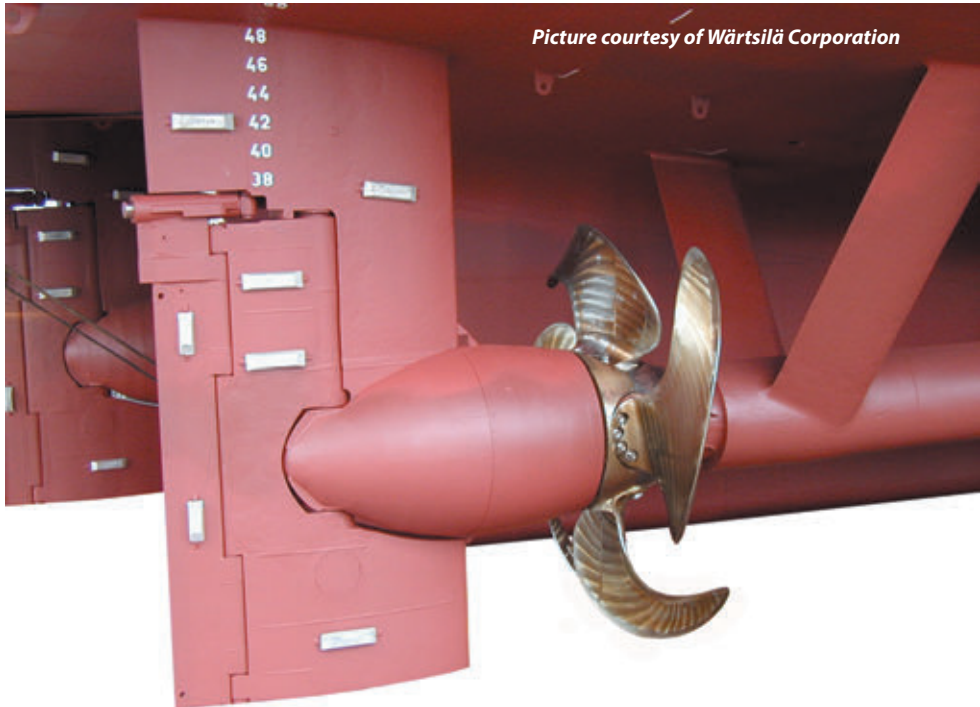

Wärtsilä Efficiency Rudder

ISO 8178 cycles. The NO_x value has to be calculated using different weight factors for different loads that have been corrected to ISO 8178 conditions. An Engine International Air Pollution Prevention (EIAPP) certificate is issued for each engine showing that the NO_x level complies with the Annex VI to **Marpol 73/78**.

Ejector – A pump that has no moving parts or a mechanical driver. The pumping action is created as a pressurized fluid, referred to as the motive or operating fluid supplied from an external source, passes through the ejector. Ejectors are used to remove gases or liquids from various locations on the vessel.

Ekranoplans, also wing-in-ground (WIG) effect crafts – Flying ships pioneered for military purposes in the 1930s by Russian aeronautical engineers. WIG craft flies just above sea level. Their lift is generated by an air cushion created by the ground effect, described as “an increase of lift-to-drag ratio of a lifting system at small relative distances from an underlying surface”

A WIG craft uses the same surface cushion effect as a hovercraft, but instead of an engine and fan to give lift, forward speed and large wings are used to force air under the craft. This creates a dynamic cushion, which lifts the craft clear of the surface.

Elastic limit, yield point – The maximum stress that can be applied to a metal without plastic deformation.

Elasticity – The structural member capability of sustaining stress without permanent deformation, i.e. to recover its original size and shape after the stress has been removed.

Electric motors – The electric motor converts electrical energy to mechanical energy. The most frequently used type of electric motor is the motor powered by an alternating current supply: the AC-motor. AC motors are not limited in the power they can produce and can

be considered as two main types; asynchronous and synchronous. The synchronous AC-motor is less popular, however it has higher efficiency and is frequently used as the propulsion motor in an electric drive. DC-electric motors are powered by a direct current power supply and are not frequently used. They require commutator brushes (this limits their power output), they also require more maintenance than AC-motors.

Asynchronous motor, induction motor – The asynchronous motor has the simplest design of all electric motors. It is brushless by nature and the cage rotor is very rigid, which makes relatively high speeds possible. These qualities are the reason, that the PWM frequency **converter** is designed for this type of motor. Although high-speed motors make a gearbox necessary, the weight (and price-) reduction of a high-speed motor, compared to a low-speed one is generally worthwhile. Asynchronous motors can be manufactured with power levels beyond 10MW.

Synchronous motor – The disadvantage of the synchronous motor is that it uses sliprings to power the rotor windings with DC-supply. Its rotational speed matches the frequency of the AC-supply and it runs synchronously. In case the load torque exceeds the maximum allowable torque, synchronisation will be lost and no torque will be transferred at all.

Electric network – All equipment and installations connected at the same rated voltage.

Isolated electric network – A system in which a conductor or the neutral is not connected to the ship hull in normal operation.

Electric network with earthed neutral – A system in which the neutral is connected to the ship hull in normal operation.



Photo courtesy of Wärtsilä Corporation

Podded propulsor DOLPHIN developed by Wärtsilä Lips and German electronic company STN ATLAS

Electric podded propulsor – Azimuthing electric propulsion unit with the motor located inside the underwater housing (pod) attached to the hull. Electric podded propulsors relocate more space in the hull by eliminating the inboard motors, shaftlines, steering gear and stern thrusters as in traditional propulsion systems. The concept was pioneered by Kvaerner Masa yard that developed the first **Azipod** units.

Although all the systems share a common configuration – an electric motor housed in a fully rotatable pod and coupled to a propeller – the designers have adopted different

detail solutions, selecting either: synchronous or asynchronous motors; brushless or permanent excitation; Cyclo, Synchro or PWM converters; and cooling system based on air, seawater/convection or a combination of these modes. The propulsor today is an integration of the propulsion motor, shaftline and propeller; the next step will be an integration of the supply transformer, converter and filtering.

Since the motor is the central element of the propulsion chain, a simple and reliable component is desirable, requirements that promote the permanently excited motor and the AC induction motor. Both these motor types along with PWM **converters** capable of increased voltage and power ratings create an excellent electric drive system. The cyclo-converter can perhaps maintain its market share in larger drives but it seems that the podded propulsor does not favour the synchroconverter.

Direct seawater cooling releases the top of the propulsor from air ducts, fans and heat exchangers for other auxiliaries. The work executed by the propulsor supplier can thus be extended and the work required at the yard is reduced. Cooling is an area calling for further development to find solutions for a non-air cooled rotor for an AC induction motor and to improve convection from the stator to the seawater.

Electric propulsion systems, electric drive systems – The concept of electric propulsion is over 100 years old with battery-powered vessels recorded in Russia and Germany around 1870. In 1893, one of the first electric boats ELECTRICITY carried passengers on the River Thames in England. The most famous was the 1936 built trans-Atlantic liner NORMANDIE which used electric propulsion via four 29MW synchronous motors, each powered by a dedicated turbo-generator and driving one of the four propellers.

This type of propulsion system consists of prime movers (diesels, gas turbines or steam turbines), AC generators, power conditioners (cyclo-converters, pulse-width-modulated inverters, load-commutated inverters), DC or AC propulsion motors. The term “DC propulsion system” implies that a propulsion system includes a power conditioner to convert AC to DC, such that a DC motor can be used. An “AC propulsion system” consists of a different type of power conditioner and an AC motor.

The electrical connection between a generator and the propulsion motor provides a freedom of arrangement not offered by a mechanical system.

The ability to separate the engine and the propeller, flexibility of multi-power operation and the ability to combine auxiliary propulsion are the performance and economic factors that have made electric drive a popular choice for modern cruise ships.

Electric propulsion systems are used for the following applications:

- Vessels requiring a high degree of manoeuvrability (ferries, icebreakers, tugs, cable-layers),
- Vessels requiring large amounts of special-purpose power (self-unloaders, dredges, drill ships),
- Vessels with large hotel loads,
- Vessels using non-reversing, high-speed, and multiple prime movers.

Benefits of the electric propulsion include:

- Better space utilisation permitting to carry more cargo.
- Less machinery space required.
- More efficient use of fuel resulting in reduced fuel consumption at variable operational speeds.
- Improved manoeuvrability with azimuth or podded propulsors installed.

Electrogas welding – An arc welding process that uses an arc between a continuous filler metal electrode and the weld pool, employing approximately vertical welding progression with backing to confine the molten weld metal. The process is used with or without an externally supplied **shielding gas** and without application of pressure.

Electrolytic descaling – The method of **surface preparation** which can be used for ballast tanks before drydocking. It bases on a breakdown of the rust using very strong electrical current. The current is produced by galvanic reaction between steel and large amount of magnesium anodes fitted for this purpose in the ballast tank, which is completely filled with seawater (electrolyte). This process requires one to two weeks and is accompanied by heavy hydrogen gas emission, so appropriate ventilation must be fitted. After descaling, an efficient washing of the ballast tank must be carried out, for the removal of rust and calcareous deposits formed on the tank surfaces. See also **BLASTOMATIC system**.

Electronic chart display and information system (ECDIS) – The newly developed navigational tool using digital charts (vectorised and **raster charts**) for navigational tasks normally carried out with paper charts. The equipment must be type-approved and uses up-to-date official charts. As long as the area covered by vector charts (ENC) is small, the **ecdis** should be able to cover both vector and raster (RNC) charts. When operating in raster mode, an ecdis must be used together with an appropriate folio of up-to-date paper charts.

North up/heads capability of ecdis: In the normal north up mode the ship moves across the static chart until it approaches the edge of the screen when a new section of the chart is automatically displayed. In heads up the vessel remains in the center of the display while the chart moves underneath. The vessel always appears up on the display with the image automatically rotated to the correct orientation, thereby matching the scene outside the window.

Radar overlay – A navigation system which superimposes live radar video output over ecdis. It provides a scan-converted output for display, automatically scaled to suit the displayed chart. The transparency can be adjusted so that the chart can be seen through the radar image. The overlay and its controls conform to ecdis standard for combining radar with ecdis chart display.

Electronic navigational chart (ENC), also vectorised chart – Vector charts made up of layers which can be displayed selectively. Each point on the chart is digitally mapped, allowing information to be used in a more detailed way, such as clicking on a feature to display its information. Vector charts have the advantage of being “interactive”. For instance, the operator can pre-set the vessel draught and a ½ mile exclusion zone. At any time when the vessel is within ½ mile of an area of shallow water, an alarm activates. Chart data can be shared with other equipment such as arpa and radar. There are various chart formats. Hydrographic offices are responsible for the production and accuracy of the ENC material.

Electroslag welding (ESW) – A welding process that produces coalescence of metals with molten slag that melts the filler metal and the surface of the workpieces. The weld pool is shielded by this slag which moves along the full cross section of the joints as welding progresses. The process is initiated by an arc that heats up the slag. The arc is then extinguished by the conductive slag which is kept molten by its resistance to electric current passing between the electrode and the workpieces.

Elevators – Vertical transportation facilities, passenger lifts, service/crew elevators.

Embark – Refers to any time that crew boards the ship, like initial boarding or boarding in a port of call.

Embarkation ladder – The ladder provided at survival craft **embarkation stations** to permit access to **survival craft** after launching.

Traditional means for descending to pre-launched boats using ropes and embarkation ladders are inherently unsafe. Handholds shall be provided to ensure a safe passage from the deck to the head of the ladder and vice versa.

Emergency Cable Brake, stonker – A safety mechanism to arrest the cable in the event of a catastrophic failure or danger to personnel, when the cable must be stopped immediately. The braking action is effected by clamping two parallel faces directly onto the cable using hydraulic cylinders. The design of the operating linkage ensures that the clamping motion has a self-locking action.

Emergency condition – A condition under which any services needed for normal operational and habitable conditions are not in working order due to failure of the **main source of electrical power**, (acc. to SOLAS, Chapter II-1, Part A).

Emergency consumers – Mandatory consumers, which after breakdown of the main energy supply, must be fed by the emergency energy supply.

Emergency drive systems – Emergency drive systems are typically installed in ships with geared medium-speed engines by connecting an electric motor to a pinion shaft in the gearbox (PTI) via a clutch. In normal use the motor serves as a power take-off (PTO) shaft generator.

Emergency equipment lockers – GRP cabinets weathertight to IP55 with a range of equipment to aid escape from enclosed spaces in the vessel under unusual circumstances, for instance, when there is a large angle of heel. Emergency equipment lockers are required for Ro-Ro passenger ships.

Emergency escape breathing device (EEBD) – A self-contained compressed air apparatus for escape from a contaminated environment. It consists of a compressed air cylinder with air capacity of 600 litres (15 minutes duration). Within accommodation areas all ships are to carry at least two EEBD. The quantity of EEBD within machinery spaces is dependant on the layout of the space and the number of persons normally working there.

Emergency fire pump – A seawater pump which supply the ship fire main when the machinery space pump is not available.

According to SOLAS (Chapter II-2: Construction, Part A, Reg. 4) in cargo ships of 2,000 gross tonnage and upwards, the space containing an emergency fire pump shall not be contiguous to the engine room. There are ships where meeting this requirement is not practical and SOLAS allows using such solution in special cases. Unfortunately, shipyards often use this possibility, even if arrangement of ship enables the correct solution. As the result, there are many new ships with the fire pump located just abaft the aft engine room bulkhead. In addition, the emergency fire pump sea suction and all suction piping are located in the machinery space. SOLAS allows only in exceptional cases short length of the emergency fire pump suction piping can penetrate the machinery space if enclosed in substantial steel casing. Unfortunately, such situation is tolerated by Classification Societies, which accept insulation of suction pipe to A-60 standard in lieu of steel casing. The philosophy of Classification Societies regarding the seawater inlet valve operation differs: one requires valve to be remote operated, other requires valve to be locked in open position.

The arrangement of a container ship enables the correct solution without any compromises to safety: location of the emergency fire pump and its sea suction in the bow thruster room fully complies with SOLAS requirements. In addition such solution

eliminates troublesome external piping. Much easier connections to the fire mains in underdeck passageways can be arranged with better protection against corrosion and frost.

Emergency Position Indicating Radio Beacon (EPIRB) – The 406 MHz satellite EPIRB is a small battery-powered transmitting device designed to provide rapid alerting, identification and accurate location information to search and rescue crews. As the name implies, it is used only in case of emergency and usually only as a last resort when your marine radio is inoperable or out of range.

There are several types of EPIRBs. If disaster strikes, some float free and automatically activate – others must be activated manually. All EPIRBs float and will send out a continual signal for 48 hours. Since EPIRB signals are primarily detected by satellites that pass overhead, occasionally there may be a delay in detection (perhaps an hour) if there is no satellite currently in the area to pick up the signal. Once activated, the EPIRB should be left on to make sure the signal is available for detection by the satellite and for purposes of homing in on your location.

Emergency response – All actions through alarm, escape, muster, communications and control, evacuation and rescue.

Emergency Response and Rescue Vessel (ERRV) – A purpose-built rescue vessel attending offshore installations. An ERRV should combine good manoeuvrability, enhanced survivor reception and medical after-care facilities, state of art navigational/communications equipment and rescue craft capable of operating in severe weather.

Many ERRVs are fitted with both daughter craft (DC) and fast rescue craft (FRC). In many respects the launch/recovery phases of both FRC and DC are limiting factors in respect of their use and especially the recovery operation requires a high degree of professionalism and teamwork between the craft's crew and those operating the davit on board of the ERRV.

In some cases the weather conditions are too severe to launch rescue craft, hence in such circumstances ERRVs with a mechanical recovery device are provided to recover survivors directly from the sea. The most common equipment is Dacon Scoop: a crane-operated rescue net for recovery of casualties directly from the water on board of a rescue vessel.

Further reading: UKOOA – ERRVA Emergency Response & Rescue Vessel Survey Guidelines.

Emergency services – Fire and gas detection, fire fighting equipment, emergency generator, etc. that needs to be used in an emergency.

Emergency source of electrical power – A source of electrical power, intended to supply the emergency **switchboard** in the event of failure of the supply from the **main source of electrical power**, (SOLAS). The emergency source of electrical power may be either a diesel-driven generator or an accumulator battery of sufficient capacity to provide essential circuits such as steering, navigation lights and communications when the main power supply fails.

According to SOLAS, the emergency source of the electrical power, associated transforming equipment, transitional source of emergency power, emergency switchboard and emergency lighting switchboard shall be located above the uppermost continuous deck and shall be readily accessible from the open deck. They shall not be located forward of the collision bulkhead, except in exceptional circumstances. As far as practical the space containing the

Emergency towing procedure

emergency source of electrical power and the emergency switchboard shall not be contiguous to the boundaries of machinery spaces of category A or those spaces containing the main source of the electrical power, associated transforming equipment and the main switchboard. Where is not practicable, the contiguous boundaries are to be Class A60.

Emergency engine shall be cooled by air. Cooling by water could be accepted only if pipes don't pass through machinery spaces of category A.

Air inlet and outlet openings must not be fitted with weathertight closures.

While designing an Emergency Genset Room it is necessary to foresee a way for transport of damaged generator.

Further reading: SOLAS CONVENTION.

Emergency towing procedure – Ships shall be provided with a ship-specific emergency towing procedure based on equipment available on board. The procedure shall include:

1. Drawing of fore and aft deck showing emergency towing arrangements
2. Inventory of equipment on board that can be used for emergency towing
3. Description of means and method of communication
4. Sample procedures to facilitate the preparation for and conducting of emergency towing operations.

Emergency towing system (ETS), also emergency towing gear – Equipment used to tow a ship out of danger in emergencies such as complete mechanical breakdowns, loss of power or loss of steering capability. Typical emergency towing arrangements consist of strongpoints and fairleads fitted forward and aft of the ship, on the ship centreline. Other components are pick-up gear, towing pennant, and chafing gear. To reduce the risk of pollution, tankers of 20,000 dwt and upwards should be fitted with a stern ETS (to be ready for operation under harbour conditions within 15 minutes) and an ETS on the foredeck. Similar arrangement could be required soon for all other ships greater than 20,000 tons deadweight.

Emergency towing system of 138,000m³ capacity gas carriers

In case the vessels need an emergency tow, they are fitted with two sets of equipment for the purpose. They comprise two 204t SWL **Smith brackets** fitted forward, two 200t SWL Panama fairleads, and a 7m long and 76mm of diameter Grade 3 **chafe chain**.

At the stern, there is pick up gear, a 200t SWL towing bracket, and 100m of 77mm-diameter towing wire on a storage drum.

Emergency towing vessel (ETV) – Advanced pollution prevention and control ship designed to deal with a wide range of potential maritime incidents. Among her principal roles are, towage and salvage assistance to casualties at sea, deep sea towing, fire fighting and anti-pollution duties. An adapted offshore anchor-handling supply vessel configuration is proving to be the most popular and Rolls Royce Marine has been quick to offer suitable variants of their UT design for the purpose.

Emission – Any release of substances subject to control by Annex VI of **MARPOL 73/78** from ships into the atmosphere or sea. See also **exhaust gas emissions**.

Emulsion – A homogeneous dispersion of two immiscible liquids. Oil-in-water emulsion consists of small oil droplets dispersed in a continuous water phase.

Emulsion paints – Paints in which the **binder** is dispersed in water. The paints dry as soon as the water evaporates and the emulsified droplets of resin join together to form a solid **film**.

Enclosed space – Space bounded by floors, bulkheads and/or decks that may have doors, windows or other similar openings.

Energopac - Wärtsilä and Becker Marine Systems jointly developed the Energopac system. With both the propeller and rudder design integrated, each Energopac is entirely optimized for propulsive efficiency whilst not giving in on either manoeuvrability or comfort level. It consists of several components which vary in design and dimensions, adapted to the vessel: there is a propeller installation, a streamlined fairing cap and a rudder system with an efficiency bulb.

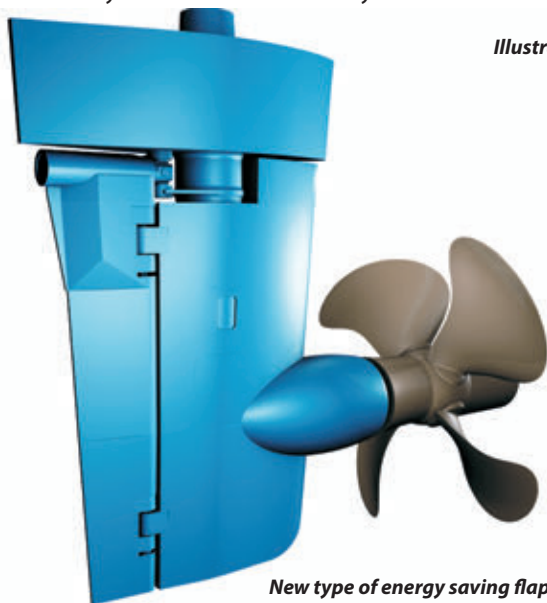

Illustration courtesy of Wärtsilä Corporation

New type of energy saving flap rudder integrated with the propeller

The **rudder** of the Energopac comes with a full spade blade and a flap mechanism. This provides excellent rudder balance and manoeuvring capabilities in the first place; secondly this allows for a smaller rudder area, resulting in lower rudder drag. The patented support system is used to design very slim rudder blades, also meaning low rudder drag; it also enables delivering any size of Energopac system to any size of vessel. The leading edge of the rudder is twisted and subsequently more aligned with the propeller slipstream, resulting in better inflow angles and improved cavitation behaviour of the rudder.

The propeller is designed by Wärtsilä for high efficiency and is part of the Energopac solution. The fairing cap and efficiency bulb are specifically shaped to reduce the separation losses behind the propeller hub and increase total efficiency. The bulb has another effect; its bulbous shape reduces the water velocity through the propeller plane. Consequently the average wake fraction of the vessel is increased and thus also the hull efficiency goes up. The fairing cap is attached to the propeller hub; the efficiency bulb is fixed to the rudder blade.

Reduction on fuel consumption depends on the type of vessel and its operational profile. The performance improvements determined through computational fluid dynamics (CFD) calculations and/or model tests indicate power reduction values ranging from a minimum of 2% to a maximum of 9%. Recent trials of 17,700dwt vessels carried out in cooperation with the Spliethoff Group has shown that the Energopac saves nearly 4% power in design condition.

ENERGY BRIDGE concept – In 2001 Belgian shipowner Exmar and US charterer Excelerate Energy worked together with Korean shipbuilder Daewoo Shipbuilding & Marine Engineering (DSME) to develop a flexible solution for the discharge of LNG. The Energy Bridge concept involves fitting **LNG tanker** with an onboard regasification plant and a swivel mooring **turret** and manifold, and providing a suitable offshore buoy and pipeline system through which to discharge the LNG into gas grid ashore, without the need for a full LNG terminal on land. The concept also allows the vessels to discharge LNG direct ashore at any terminal with a gas receiving line, without the need for a special LNG single buoy mooring. See also **LNG RV**.

Energy Efficiency Design Index (EEDI) – The CO₂ emission index used to evaluate the vessel design. The index compares theoretical CO₂ emissions and transport work of a vessel (gCO₂/tnm). The goal is to design future ships with a design index to be stepwise reduced in the period from 2012 to 2018 to a maximum level of possibly 70% compared with the 100% design index valid for average currently designed ships. In August 2009, IMO has published guidelines on the calculation and verification of the EEDI.

Further reading: MEPC.1/Cir.681 and 682

ENGARD control unit – A computer system developed by Alfa Laval. The system optimizes the central cooling operations on board a ship. It monitors the seawater temperature and heat load conditions in order to adjust the pump output to the actual operating conditions.

Without a system to regulate seawater pumps, central cooling systems waste energy as their pumps operate at full speed even when the heat load is reduced. ENGARD automatically regulates the motor in seawater pumps to meet the need for seawater.

Engine – A machine for converting heat energy into useful mechanical work. It may be further described with regard to its operating cycle, speed or the source of energy.

Four-stroke engine – An engine in which the pistons complete their working strokes every second engine revolution.

Two-stroke engine – An engine in which the pistons complete their working strokes every engine revolution.

Engine margin – An engine margin, normally 10-15% of its **maximum continuous rating** (MCR), is recommended in order to lower fuel and maintenance costs and to have reserve power for increased speed. This means that specified service speed is to be achieved with 85-90% of the MCR.

Engine room – The compartment on board a ship that includes the main propulsion machinery as well as the control room, the auxiliary machinery and other equipment.

Engine room arrangement – To obtain good working conditions in the **engine room**, it is necessary to investigate its layout from a very beginning of any design. Attention shall be paid to the ventilation, transport ways, escapes, maintenance hatch and space for maintenance etc. The accommodation block is usually arranged above the engine room and both of them must be very well coordinated to create one logical solution. Detailed Engine Room Arrangement with the Index of Machinery and Equipment shall be the part of the Contract Design.

Engine room safety station – An easily accessible room outside the machinery space with means of closing engine room ventilation, boiler blowers, fuel transfer pumps and fuel valves, as well as means of releasing of fire extinguishing system.

ENGINE ROOM ARRANGEMENT

Designed by BNC
www.betterships.com

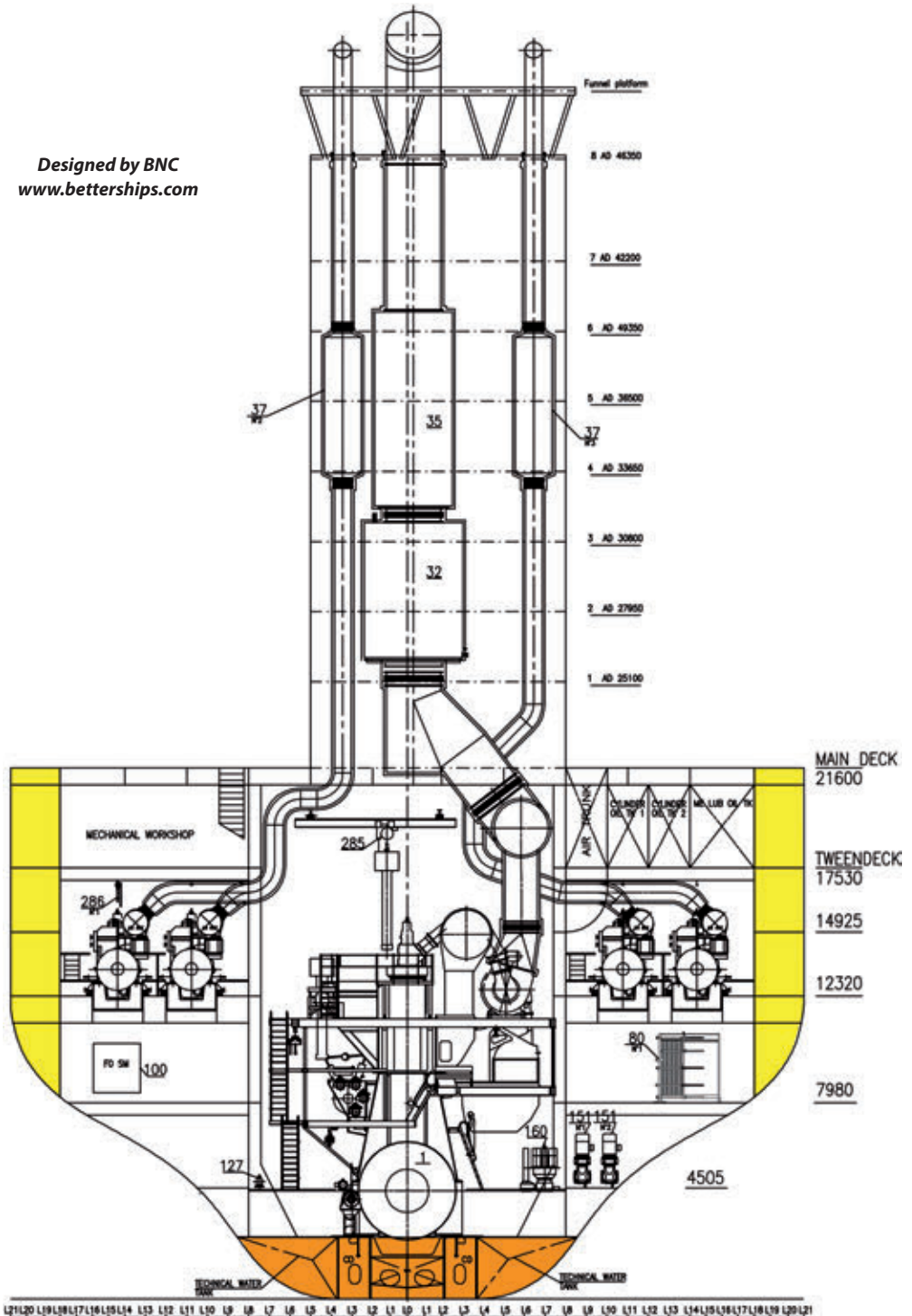

ENGINE ROOM ARRANGEMENT

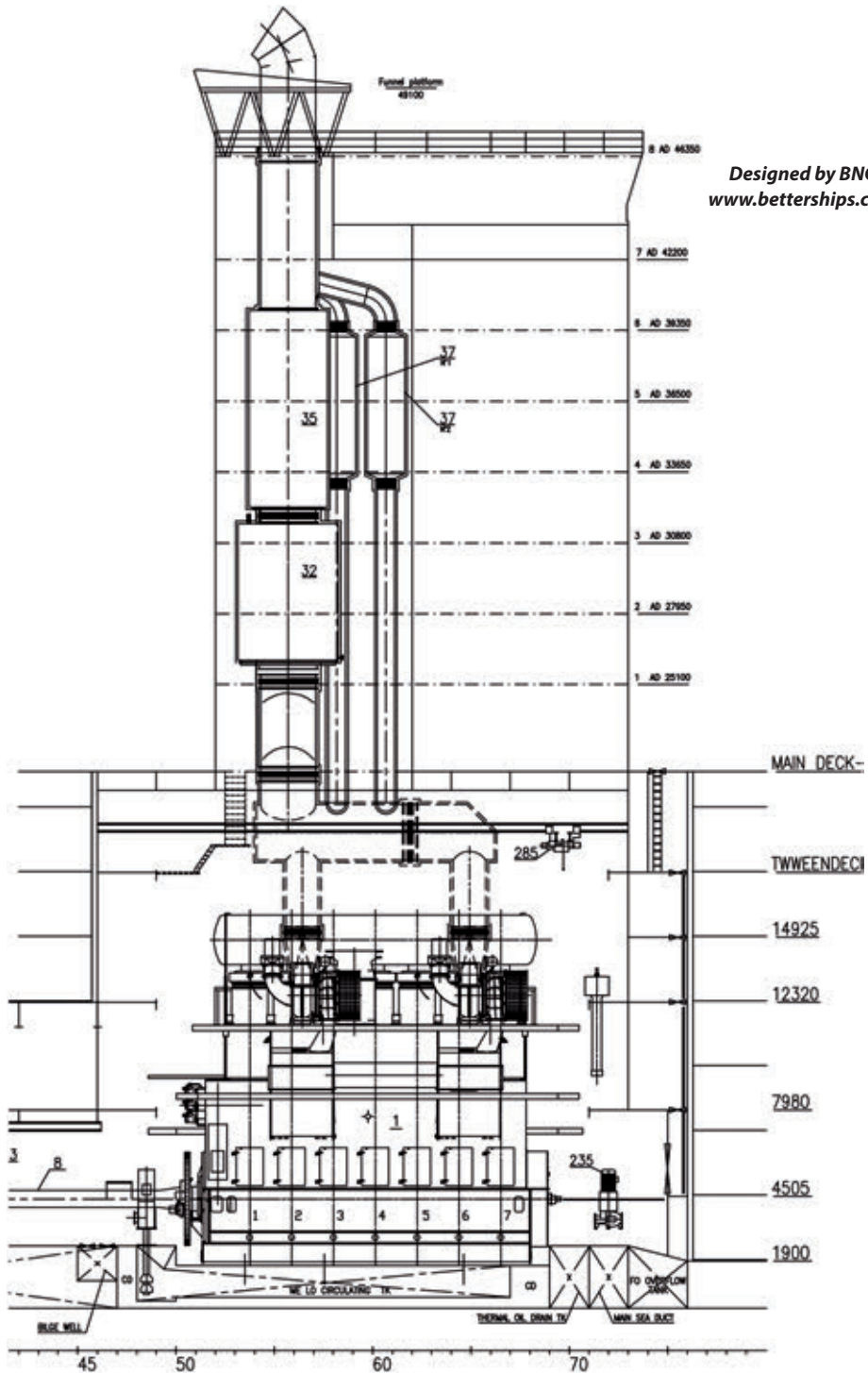

ENGINE ROOM ARRANGEMENT



ENGINE ROOM ARRANGEMENT



Engine room ventilation – Special attention should be paid to the engine room ventilation in order to ensure trouble free operation of all equipment. The air intake shall be located 4500mm above the freeboard deck or 2300mm above the superstructure deck as required by Load Line Convention for non-weathertight openings. Water spray, rainwater, dust and exhaust gases must not enter the ventilation trunks. Location of air intakes should be investigated from the stage of the conceptual design of the vessel to avoid problems later. The arrangement of main air trunks should be co-ordinated with hull structure to avoid cutting large openings in primary members.

The amount of air required for ventilation should be calculated from the total heat emission to evacuate. All heat sources shall be considered: main and auxiliary engines, exhaust gas piping, alternators, boilers with steam and condensate piping, electric appliances, lighting, and tanks.

The combustion air for main and auxiliary engines should be delivered through dedicated ducts close to the turbochargers.

Careful calculations are normally done to find the exact total amount of supply air, but as a quick estimate is often used. The following figures are for a diesel ship:

- Main engines: BHP X $6\text{ m}^3/\text{h}$
- Auxiliary engines: BHP X $4.75\text{ m}^3/\text{h}$
- Boiler : kg steam/h X $1.25\text{ m}^3/\text{h}$

The total fan capacity will be the sum of the above consumption plus 50%. The ventilation air is to be equally distributed considering airflows from points of delivery towards the exits.

Engine trials – Various tests undertaken on main propulsion and auxiliary machinery during sea trials.

Engineer – An officer who is qualified by training and examination to operate and maintain machinery.

Entry – A custom form used for the clearance of ships or merchandise.

Environmental control – A number of chemical substances react with oxygen or other gases. This reaction may affect the quality of the cargo or can generate a hazardous situation. The atmosphere within cargo tanks containing such substances is, therefore, required to be environmentally-controlled. Four types of environmental control are used, namely **inerting, drying, padding and ventilation**.

Environmental load – A load that acts on a structure that is the result of environmental conditions (e.g. thermal loads arising from temperature variations etc).

Epoxy resins – Liquids that can be poured and cured at room temperatures. The cured material is tough, solid, durable and unaffected by oils and seawater. It may be used as a chocking material for engines, for adhesives or as a surface coating e.g. paint, because of its good adhesion property.

High-build epoxy – An epoxy resin with additives in order to improve its strength and resistance to abrasion (e.g. calcium carbonate, metal fibers and powders, and glass fibers).

Equipment number – A dimensionless parameter used to determine the size and number of anchors and chain cables for a new ship.

However, it is important to remember that the anchoring equipment determined in accordance with the “Equipment Number” is intended for temporary mooring of a vessel within a harbour or sheltered area, when the vessel is awaiting berth, tide, etc. The equipment is, therefore, not designed to hold a ship off fully exposed coasts in

Erecting

rough weather or to stop a ship which is moving or drifting. Furthermore, this anchoring equipment is designed to hold a ship in good holding ground. In poor holding ground the holding power of the anchors will be significantly reduced.

Erecting, erection – The process of hoisting into place and welding together the various parts of a ship hull.

Ergonomics – Application of the human factor in the analysis and design of equipment and working environment. The aim is to improve efficiency and the health and comfort of those working.

Erosion – The destruction of metals or other material by the abrasive action of moving fluids, usually accelerated by the presence of solid particles or matter in suspension. See also **cavitation erosion**.

Erosion damage – The physical removal of material from a surface by mechanical means such as e.g. flowing liquid. It may be accelerated by **corrosion**.

Error – The difference between an actual and the ideal or desired value or condition.

Escape route – A clearly marked way in the vessel which has to be followed in case of emergency.

Escape trunk – A vertical trunk fitted with a ladder to permit personnel to escape after being trapped.

Escort – Attending a vessel, to be available in case of need, e.g. **icebreaker**, **tug**, etc.

Essential equipment – All equipment necessary to ensure propulsion and steerability of the ship, safety of passengers and crew, cargo, ship and machinery. Essential equipment is subdivided into the primary and the secondary ones.

Primary essential equipment – The equipment required to be operative at all times to maintain the propulsion and steering of the ship.

Secondary essential equipment – Equipment required for safety of the ship, passengers and crew. It can briefly be taken out of service without propulsion and steering of the ship being unacceptably impaired.

Essential services – The electricity supply to services required for navigation, propulsion and the safety of life.

Ethanol fuel – Alcohol-based fuel made by fermenting and distilling sugar cane or starch crops such as corn. It can also be made from cellulosic biomass such as trees and grasses.

Evacuation – Evacuation means leaving the ship, also an offshore unit or installation and moving away from the vicinity in an emergency in a systematic manner and without directly entering the sea. Until recently the standard methods to evacuate were by **lifeboats** or **liferrafts**. New options have evolved over the last decade and the following methods are available:

- helicopter evacuation,
- evacuation by means of rigid crafts (boats or capsules),
- davit-launched rigid or inflatable liferafts,
- **marine evacuation systems** (MES),
- inflatable through-overboard liferafts.

Evaporation – Change of any liquid into vapour at any temperature below its boiling point. For example, water, when placed in a shallow open container exposed to air, gradually disappears, evaporating at a rate that depends on the exposed area, the air humidity, and

the temperature. Evaporation occurs because among the molecules near the surface of the liquid there are always some with enough heat energy to overcome the cohesion of their neighbors and escape (see adhesion and cohesion; matter). At higher temperatures, the number of energetic molecules is higher, and evaporation is more rapid. Evaporation is also increased by increasing the surface area of the liquid or by speeding up the air circulation, thus carrying away the energetic molecules leaving the liquid before they can be slowed enough by collisions with air molecules to be reabsorbed into the liquid. If the air is humid some water molecules from the air will pass back into the liquid, thus reducing the rate of evaporation. An increase in atmospheric pressure also reduces evaporation. The process of evaporation is always accompanied by the cooling effect. For example, when a liquid evaporates from the skin, a cooling sensation results. The reason is, that only the most energetic molecules of liquid are lost by evaporation, so that the average energy of the remaining ones decreases; the surface temperature, which is a measure of this average energy, decreases also. Many refrigeration processes are based on this principle.

Examination of the hull structure – The overall examination is intended to report on the overall condition of the hull structure and determine the extent of additional close-up examinations. In the close-up examination, the details of structural components are within the close visual range of the surveyors, i.e. normally within hand reach.

Exhaust emission – Any substance which, if introduced into the sea or atmosphere, is liable to create hazards to human health, ecosystems, or marine life, to damage amenities, or to interfere with other legitimate uses of the sea, (IMO).

Exhaust emissions from marine diesel comprise nitrogen, oxygen, carbon dioxide (CO₂), carbon monoxide (CO), oxides of sulphur (SO_x), nitrogen oxides (NO_x), **particulates**, water vapour and **smoke**. Oxides of nitrogen and sulphur are of deep concern as the threat to human health, vegetation and the environment.

Annex VI of **MARPOL 73/78** defines requirements for control of emissions from ships.

Exhaust gas, flue gas – The gas which leaves a system after energy exchange or conversion process, e.g. combustion gases from a **diesel engine**, a **boiler**, a gas turbine or an **incinerator**.

The exhaust gases of diesel engines mainly consist of nitrogen, carbon dioxide (CO₂) and water vapour with smaller quantities of carbon monoxide (CO), sulphur oxides (SO_x) and nitrogen oxides (NO_x), partially reacted and non-combusted hydrocarbons and particulates.

Exhaust gas boiler MISSION™ XW from Aalborg Industries

A water tube exhaust gas boiler with forced water circulation designed for heat recovery from engine exhaust gas. The boiler is used in connection with one or more oil fired boilers which act as steam/water space. Water at saturation temperature is pumped from the oil fired boiler(s) into the exhaust gas boiler by the circulation pumps. In the MISSION™ XW boiler, heat from the engine exhaust gas is transferred to the water side by convection. The generated steam/water mixture is then discharged into the steam space of the oil fired boiler(s) where the heavier water particles separate from the steam.

The heat transfer surface is build up of vertical registers which consist of horizontal finned double steel tubes. The tube registers, including tube bends and tube supports, are placed in the exhaust gas flow. The design of the tubes gives an effective compact heating surface and

Exhaust gas cleaning system (EGCS)

prevents vibration from exhaust gas pulsations. The heating surface can be cleaned easily by means of soot-blowers. The cleaning medium is either compressed air or steam.

The boiler requires a continuous forced circulation of water through the boiler as dry running would seriously increase the danger of a fatal soot fire. The forced circulation must be provided by at least two circulating pumps. One pump must be kept in continuous operation (also in port) and the other one in automatic stand-by operation mode.

Exhaust gas cleaning system (EGCS) – Alternative compliance method at least as effective in terms of emission reductions as that required by Regulation 14 of Annex VI to MARPOL 73/78, which requires ships to use fuel oil with a limited sulphur content. Usually refers to SO_x scrubbers.

EXHAUST GAS EMISSIONS FROM SHIPS

Exhaust gas emissions increasingly become a more stringent topic of public interest in the context of merchant shipping industry. Exhaust emissions from marine diesel engines comprise nitrogen, oxygen, carbon dioxide (CO₂), carbon monoxide (CO), oxides of sulphur (SO_x), nitrogen oxides (NO_x), hydrocarbons, water vapour and smoke. Oxides of nitrogen and sulphur are of special concern as threats to vegetation, the environment and human health.

Ship	Power (kW)	Speed (kn)	HFO/24h	CO ₂ /24h	NO _x /24h	SO _x /24h	Particulates
CV8500TEU	62,000	26.5	283t	878t	26t	17t	3t
Bulker 35,000dwt	6300	14	26t	85.4t	2.7t	1.6t	0.3t

NO_x emissions

During combustion, most of the nitrogen oxides (NO_x) are generated in the high temperature spots by a reaction between the atmospheric nitrogen and oxygen. Nitrogen oxides cause eutrophication, acidification and the formation of ozone in the presence of VOC and sunlight. These NO_x emissions can be abated by using primary and/or secondary methods. Primary methods aim at reducing the formation of NO_x emissions in the engine using engine design methods, or additionally through water injection or exhaust gas recirculation. For ships requiring the lowest possible NO_x emissions, the only viable solution available today is to treat the exhaust gases after engine using **Selective Catalytic Reduction** (SCR). The SCR technology can cut emissions by well over 90%, to less than 2g/kWh. It is equally applicable to low-speed and medium speed engines. However, the lower exhaust temperatures of low-speed engines mean that the SCR unit must be located before the turbocharger.

For the SCR to operate, ammonia is required as a reducing agent to allow the chemical reaction to take place as the exhaust gases pass through the catalyst honeycomb. In practice a 40% aqueous solution of urea is used. Urea is favoured as a reducing agent because it is colourless, odourless, non-toxic, biologically harmless and can be transported and stored without problems.

The SCR system consists of a reducing agent storage tank, a reducing agent feeding and dosing unit, a reactor with catalyst elements and a control system. See also NO_x Reducer System.

IMO NO_x emission standards

The NO_x emissions limits in the IMO standards are expressed as dependent on engine speed. The IMO Tier 1 NO_x emission standard applies to ships built from year 2000 until end of year 2010.

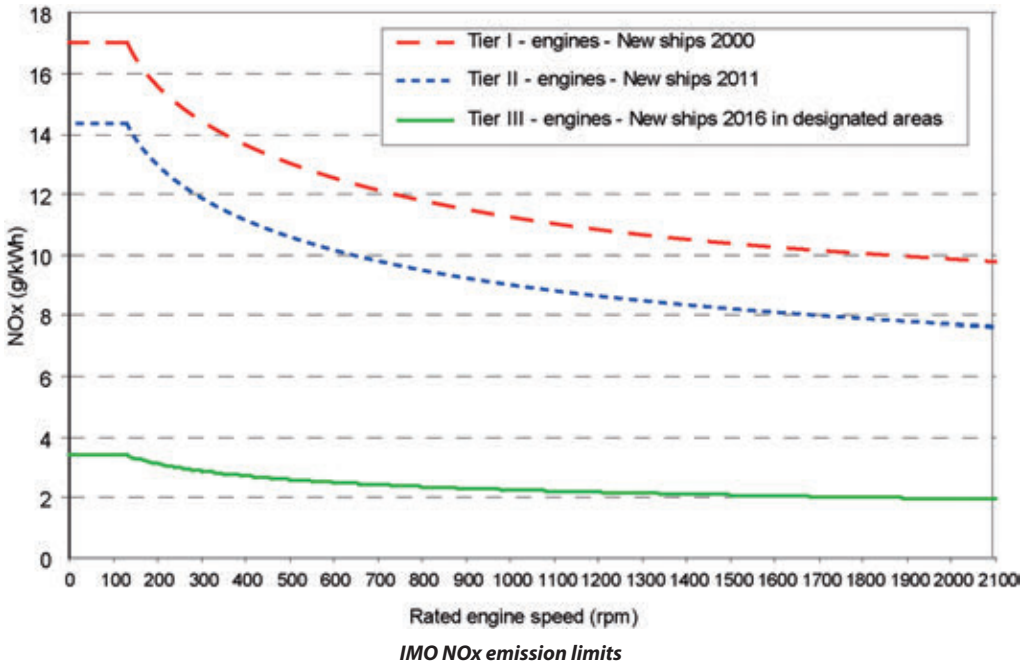

The IMO Tier 2 NO_x emission standard entered into force on 1st January 2011 and applies globally for new marine diesel engines over 130 kW installed on ships which keel laying date is 1st January 2011 or later. IMO Tier 2 NO_x emission levels correspond to about 20% reduction from the IMO Tier 1 NO_x emission standard. This reduction is reached with engine optimization.

The IMO Tier 3 NO_x emission standard will enter into force on 1st January 2016. The IMO Tier 3 NO_x standard applies only for new marine diesel engines over 130 kW installed in ships which keel laying date is 1st January 2016 or later, when operating inside designated emission control areas (ECA). The IMO Tier 3 NO_x emission level corresponds to an 80% reduction from the IMO Tier 1 NO_x emission standard. The reduction can be reached by applying a secondary exhaust gas emission control system.

SO_x emissions

SO_x as a product of fuel oil combustion can be reduced by decreasing the sulphur content in the fuel. In October 2008 the Marine Environment Protection Committee (MEPC) of the IMO agreed on the progressive reduction of the maximum sulphur content in fuels used on board ships. The revised Marpol Annex VI regulations reduce the global sulphur cap to 0.5%, effective from 1st January 2020. The limit applicable in SO_x Emission Control Areas (SECA) has been reduced to 0.1%, effective from 1st January 2015.

Exhaust gas cleaning systems that reduce the emission of sulphur oxides to the same extent are approved by IMO: see **WÄRTSILÄ SO_x SCRUBBER SYSTEMS**.

Exhaust gas recirculation (EGR)

Exhaust gas recirculation (EGR) – Nitrogen oxides (NO_x) emission reduction technique used in a reciprocating internal combustion engine, which involves diluting the intake air with recirculated exhaust gases.

Exhaust gas turbocharger – A turbine wheel driven by exhaust gases from the engine rigidly coupled to a centrifugal air compressor.

Exhaust valve – The valve through which exhaust gases leave the engine. The exhaust valve consists of a valve housing and a spindle.

Expansion trunk – A trunk extending above a space which is used for stowage of liquid cargo. The surface of the liquid cargo is kept sufficiently high in the trunk to permit expansion without risk of excessive strain on the hull or of overflowing, and to allow contraction of the liquid without increase of free surface.

Explosion-proof, also flame-proof – Electrical equipment is defined and certified as explosion-proof when it is enclosed in a case, which is capable of withstanding within it the explosion of a hydrocarbon gas/air mixture, or other specified flammable gas mixture. It must also prevent the ignition of such mixture outside the case either by spark or flame from the internal explosion or as a result of the temperature rise of the case following the internal explosion. The equipment must operate at such an external temperature that a surrounding flammable atmosphere will not be ignited.

Explosion relief valve – A relief valve fitted to the engine **crankcase** doors as a safeguard against explosions. It relieves excess pressure, stop flames being emitted and prevent from the entry of air into the crankcase.

Explosive mixture – A vapour-air or gas-air mixture that is capable of being ignited by a source that is at or above the ignition temperature of the vapour-air or gas-air mixture.

External cylinders – Hydraulic cylinders mounted outside the hatch covers used for opening and closing them.



Photo: J. Babicz

External cylinders

Fabrication – Various processes of producing the structural ship parts.

Fabrication shop – A shipyard facility where plates and profiles are cut and welded together.

The assembly systems begin with plates and profiles being moved into a fabrication shop. The first step is usually the cutting of plates. Gas-oxygen flame or underwater plasma arc processes are used for cutting. Flame cut sections may need straightening. This can be done through multiple rolls. Panel line system provides welding flat plate panels, attaching stiffeners with automatic welding, and moving the panels along a line where webs and other steel members may be attached.

Fabrication tolerance – A permissible deviation from a specified value, expressed in actual values or more often as a percentage of the nominal value.

Face plate – Generally, a narrow stiffening along the inner edge of web frames, stringers, etc, to form the flange of the member.

Fail-safe – A system or a machine is fail-safe when, upon the failure of a component or subsystem or its functions, the system or the machine automatically reverts to a designed state of least critical consequence.

Failure mode and effect analysis (FMEA) – A failure analysis methodology used during design to postulate every failure mode and the corresponding effect or consequences. The analysis begins by selecting the lowest level of interest (part, circuit, or module level). Various failure modes that can occur for each item at this level are identified and enumerated. The effect for each failure mode, considered singly and in turn, is to be interpreted as a failure mode for the next higher function level. Successive interpretations will result in the identification of the effect at the highest function level, or the final consequence. A tabular format is normally used to record the results of such a study.

Fairlead – A guide for a mooring line which enables the line to be passed through a ship bulwark or other barrier, or to change direction through a congested area without snagging or fouling.

Panama-type fairlead, Panama chock – A non-roller type fairlead mounted at the ship side and enclosed so that mooring lines may be led to shore with equal facility either above or below the horizontal. Strictly refers to fairleads complying with Panama Canal Regulations, but often applied to any closed fairlead or chock.

Pedestal roller fairlead, pedestal roller guide – Part of mooring equipment used to change the direction of a rope or wire in order to provide a straight lead to a winch drum.

Universal roller fairlead – Universal roller fairlead consists of several cylindrical rollers, or a combination of rollers and curved surfaces.

Fairway – Navigable part of a waterway.

Fairway speed – Mandatory speed in a fairway.

Fall – The rope with blocks making up a **tackle**. The end secured to the block is called the standing part; the opposite end, the hauling part.

Fall preventer devices (FPD) – Arrangements that provide a physical barrier to inadvertent on load hook release. These can be strops attached to a strong point other than the hook on the boat and to the fall block during launching and recovery procedures or an approved metal pin inserted in the hooks to prevent release. Nylon loop strops of

sufficient safe working load are recommended as they can absorb shock loads and can be easily cut in an emergency. See also **On-load release hooks**.

Fallpipe rockdumping vessel – A very specialized ship consisting of a hold in which graded rock is stocked. The rock material is placed at an exact location on pipelines or the sea bottom through a fallpipe. At the lower end of the fallpipe a **Remote Operated Vehicle** (ROV) is fixed. This ROV is operated from the deck and controls the rock placement in three dimensions.

Offshore rock placement is applied mostly to stabilise and protect pipelines, flowlines and power cables.

Falls – Wires or ropes used to hoist or lower a boat or cargo.

Fan – Generally applied to radial- and axial-flow blowers that increase the density of the air passing through them by a maximum value of 5%. Various types are in use, e.g. centrifugal, axial flow and propeller fans.

Fathom – A measure of length, equal to 6 linear feet, used for depths of water and lengths of **anchor chain**.

Fatigue – It refers to the failure of materials exposed to repeated actions of stress fluctuation. It is responsible for a large proportion of cracks occurring in welded ship structural details.

The loads responsible for fatigue are generally not large enough to cause material yielding. Instead, failure occurs after a certain number of load or stress fluctuations. The fatigue strength of welded structural details does not depend on the tensile strength of the steel.

Fatigue crack, fatigue fracture – A crack that results from the continued application of a cyclic load.

Fatigue endurance – The ability of a metal component or structure to perform without suffering any consequences of fatigue loadings.

Fatigue life – The period during which a structural member may operate without suffering reductions in strength due to the action of repetitive loads.

Fatigue limit – The maximum number of cycles in load application to a structure that can be applied before the appearance of any effects of fatigue (cracks).

Fatigue strength – The strength against crack initiation under dynamic loads during operation.

Feed check valve – A boiler feed water supply valve which is non-return but can be also regulated.

Feed heater – A **heat exchanger** which increases the temperature of boiler feed water, usually by using some form of waste, or exhaust steam that is condensed.

Feed water – Distilled water supplied to a **boiler**, usually by high-pressure pump (feed pump), to compensate for water lost by vapourisation. It is usually treated to remove air and impurities.

Feed water treatment – The process of adding various chemicals to the feed water system and then testing samples of boiler water with a test kit.

Feeder service – Cargo to/from regional ports is transferred to/from a central hub port for a long-haul ocean voyage.

Feeler gauge – A thin metal strip of a particular thickness, with the value marked upon it. It is used for the precise measurement of gaps.

Fender – A resilient device built into (permanent fender) or hung over the sides to prevent the shell plating from rubbing or chafing against other ships or piers.

Foam filled fender – In this type of a fender, the core consists of closed-cell, resilient, energy absorbing foam covered with protective, seamless polyurethane elastomer skin.

FERRIES



Photo courtesy of STX Europe

COTENTIN

The term “ferry” originally described a vessel carrying passengers or cargo on short trips across rivers or harbours or coastwise to inland. The USCG defines a ferry as a vessel, “having provisions only for deck passengers and/or vehicles operating on a short run on a frequent schedule between two points with the most direct water route offering a public service of the type normally attributed through a bridge or tunnel”. Ferries nowadays are primarily used to carry passengers and their cars, as well as large numbers of heavy-freight vehicles. The car and cargo capacity of the ferries has grown significantly during the 90’s. The number of ro-ro decks has increased from initially only one to two or even three full height trailer decks. In addition, many ferries have a lower hold to increase the cargo capacity further on. *BIRKA PARADISE* is fitted with four Wärtsilä 6L46 main engines, each developing 5860kW at 500rpm splitted between two engine rooms. Electrical power comes from four Wärtsilä/Leroy-Somer 3312kVa alternators.



Photo courtesy of STX Europe

Cruise ferry BIRKA PARADISE

Cruise ferry – A ferry with cabin space for all passengers and large public spaces with restaurants, lounges, bars, etc. Cruise ferries operate on overnight routes and some passengers are on a “cruise” and travel back with ferry on the return trip. The ro-ro decks are small and the passenger cars occupy a large part of the ro-ro space.

Double-ended ferry – A shuttle ferry with **propellers** at both ends, featuring an identical fore and aft body. Double-ended ferries are commonly used on short commuter runs where the time lost while turning around a single-ended ferry at each end of the crossing makes a considerable percentage of the time required for the trip, and, thus, the double-ended ferry can transport more units per hour than a single-ended ferry of the same size. See also **Double-ended ferry COASTAL RENAISSANCE** and **Double-ended ferry BASTØ III**.



Photo courtesy of STX Europe

Fast monohull ferry HSC GOTLAND

Fast ferries – Various vessels in the 600 – 1000dwt capacity range, with a service speed well above 30 knots. Weight minimizing is a major consideration in the design of fast ferries. Most designs favour aluminium wavepiercing **catamarans** or steel monohulls. Propulsion is provided either by diesel engines or by gas turbines. Fast ferries are designed to carry passengers and a variable mix of cars and freight on shortsea routes (15-250 nautical miles). They operate between dedicated docking systems, including berths, linkspans and terminals. Introducing fast ferries created new reasons for travel and provided a good growth in business for operators. See also **Catamaran fast ferry FRANCISCO**.



Photos: P-H. Sjöström

PaxCar ferry STENA BRITANICA 3500 lane metres, 900 passengers

PaxCar ferries – Ferries with passenger facilities suitable for longer routes. They have a full-length **superstructure** to accommodate the passenger cabins and public spaces. Hoistable car platforms are often installed to increase the deck area for private cars.

Main propulsion is provided by four 10,395kW/500rpm, Wärtsilä 9-cylinder L46D engines, connected in pairs to two twin-input/single-output reduction gearboxes, and then to a CP propeller running at 150rpm. The combined MCR output is 41,580kW and the recorded trial speed 25 knots.



The Italian built giant RoPax ferry FINNSTAR for Helsinki/Travemuende link, 4200 lane metres, amenities provided for up to 500 passengers

RoPax ferries – Ferries with large ro-ro decks and limited passenger facilities. This type often has a lower hold, the main deck and upper deck for ro-ro cargo. The deckhouse is lengthened to accommodate space for passengers. The upper ro-ro deck is then partly covered. Most RoPax ferries have both stern and bow ramps to speed up the loading and unloading.

Field development ship SAIBOS

According to **The Motor Ship March** 2001.

Mutli-purpose crane and pipe laying ship SAIBOS is a dynamically positioned vessel designed to meet the requirements of deepwater field development work. The J-lay tower onboard is capable of installing 457 mm diameter rigid pipes (measuring up to 559mm with insulation), at water depths of 2000m. The unique hull and J-lay tower arrangement is further intended to facilitate the laying of flexible and umbilical gear.

For sub-sea operations, there are two elevator decks on the stern, each of which can accommodate a remote operated vehicle (ROV). These ROVs can work at depths of between 2000m and 3000m. It is also possible to install a transferable diving system enabling operations with a submerged bell connected to the vessel via rope and/or umbilical connection.

High manoeuvrability has been achieved through the installation of a total of six Wärtsilä Lips **thrusters**. At the fore end, there are two azimuthing, retractable thrusters, each rated at 2200kW, while two 4400kW rated azimuth stern thrusters are suitable for both dynamic positioning and propulsion. The bow thrusters are of a tunnel type design and are rated at 2000kW.

Field of vision

To meet the heavy lift requirements when operating in offshore fields, the vessel is equipped with a huge crane. This has a safe working load under the main hook of 600t at a working radius of 30m, and 300t at 55m outreach. Using the whip hook, the crane can lift up to 70t at a working radius of 62m. The main crane is supported by a total of four auxiliary cranes onboard.

The pipe laying system onboard SAIBOS is arranged around a single-laying axis, which is suitable for both rigid and flexible pipes. When rigid pipes are laid, the 400t SWL J-lay tower, which has an adjustable angle of between 45° and 95°, is used.

The pipe handling is undertaken by a radial "hang-off" clamp and an elevator fitted with an adjustable radial clamp driven by a regenerative tower winch. The assembly station within the J-lay tower has an opening to allow access to large items up to 4m high, 2m wide and 6m long. Flexible piping is laid through the gutter and three retractable four-track tensioners of a total SWL of 270t. This system can accommodate pipes of an internal diameter of 432mm.

Length b.p.: 152m, Breadth: 30m, Depth: 12.4m, Scantling draught: 8m, Lighthship weight: 16,749t, Cruising speed: 12.5 knots, Main engines: 4x Wärtsilä 16V26, 2x Wärtsilä 8L26.

Field of vision – Angular size of the scene that can be observed from a position on the ship's bridge.

Filler metal – The metal or alloy added in making a welded, brazed, or soldered joint.

Fillet – A rounded corner created at an inside angle of a structure or casting.

Film – Continuous coating made by the application of one or more coats onto the surface.

A "wet film" is the one that has just been applied, before solvent evaporates. After drying process, the film is called "dry film".

Film thickness – The thickness of the paint or paint system.

Dry film thickness – The thickness of a protective coating following drying.

Wet film thickness – The thickness of a protective coating immediately after its application.

Filter – A device used for mechanical separation of solid contaminants from a liquid or a gas.

Fine mesh filters are used to remove the smallest particles of dirt from oil before the oil enters the finely machined engine parts. The filtering substance may be a natural or synthetic fibrous woolen felt or paper.

By-pass filter – A filter, which provides an alternative unfiltered flow path around the filter element when a preset differential pressure is reached.

Duplex filters – Duplex filters are similar to **simplex filters** except for the number of elements and provision for switching the flow through either element. A duplex filter may consist of a number of single element filters arranged for parallel operation, or it may consist of two or more filters arranged within a single housing. The full flow can be diverted, by operation of valves, through any single element.

Full-flow filter – The term full-flow applied to a filter means that all the flow into the filter inlet port by-pass through the filtering element. In most full-flow filters, however, there is a bypass valve preset to open at a given pressure drop and divert the flow past the filter element. This prevents a dirty element from restricting flow excessively.

Simplex filter – The simplex filter has one or more cylindrically-shaped fine mesh screens or perforated metal sheets. The size of the opening in the screens or the perforated metal sheets determines the size of particles filtered out of the fluid. The design of this type of filter is such that total flow must pass through a simplex filter.



Photo: C. Spigarski

Main Engine fuel oil duplex indicator filter



Photo: J. Babicz

BOLL&KIRCH automatic lub. oil filter with flushing liquid treatment unit

Filter with back flushing – A filter with an automatic cleaning function. Back flushing is carried out by reversing the fuel flow to remove contaminants from the surface of the filter.

Filtration – Filtration can be defined as the process of collecting solid particles from a fluid by passing the fluid through a filter medium where the particles are retained.

Finite element – A small part of a large continuous structure which is investigated with regards to its loading. Displacements, stresses and strains can be determined at the nodes where the various elements meet and the whole structure is thus analysed.

Finite element method (FEM) – The method of analysis of ship structures developed in 1960s. This allows to apply loads in the most realistic way and to analyse stresses with sufficient accuracy even in very complex structures.

For the past 25 years, the finite element method has increasingly been applied as a rational tool for ship structural analysis and dimensioning. The development of advanced containerships and gas carriers was only possible on the basis of detailed FEM calculations.

Fire – Fire is the result of a combination of three factors; a substance that burns, an ignition source, and a supply of oxygen. Fires are divided into three categories, according to the material involved:

Class A – solid materials extinguished by cooling below their flash point,

Class B – oils and inflammable liquids extinguished by smothering to exclude oxygen,

Class C – electrical equipment extinguished by non-conductive agents such as dry powder.

Fire Control Plan – A plan providing crucial information for rapid and efficient action of the vessel's crew during a fire. A Fire Control Plan must show the following details:

- Control stations
- Various fire sections enclosed by "A" class divisions
- Sections enclosed by "B" class divisions
- Particulars of the fire detection and alarm systems
- Particulars of sprinkler installation
- Particulars of the fire-extinguishing appliances
- Means of access to different compartments, decks, etc.
- Ventilating system including particulars of the fan control positions, the position of dampers and identification numbers of the ventilating fans serving each section.

IMO resolution A.654(16) provides a standardized set of symbols to be used. A copy of the Fire Control Plan is to be permanently stored in a prominently marked weathertight enclosure outside the deckhouse for the assistance of shore-side fire-fighting personnel.

Further reading: *ABS Guidance Notes on Fire-Fighting Systems*, can be downloaded from www.eagle.org

Fire detector – A device which can detect a fire, and provide a signal to an alarm circuit.

Fire detectors can be operated by smoke, flames, and heat, or any combination of these factors. Flame detectors are rarely used on board ships these days. Heat detectors are used in places such as the galley and laundry. Smoke detectors are used in machinery spaces, accommodation areas and cargo holds.

Fire divisions –

"H" class divisions – **Bulkheads** and **decks** that are constructed of steel or other equivalent material, suitably stiffened, and are designed to withstand and prevent the passage of smoke and flame for the 120-minute duration of a **hydrocarbon fire test**.

“A” class divisions – Bulkheads and decks constructed of steel or other equivalent material, suitably stiffened, and designed to withstand and prevent the passage of smoke and flame for the duration of the one-hour standard fire test.

“B” class divisions – Bulkheads, decks, ceilings or linings that are designed to withstand and prevent the passage of flame for at least the first half hour of the standard fire test.

“C” class divisions – Divisions constructed of approved non-combustible materials.

Fire-fighting equipment of the general cargo vessel SPAVALDA

The fire-fighting systems onboard include:

- A CO₂ extinguishing plant for the cargo holds and engine room,
- A locally operated CO₂ bottle for the separator room,
- A fog hotspot fire-fighting system.

The CO₂ flooding system for the engine room is operated with a pneumatic control system. The main control valve is located in the CO₂ room. The required number of cylinders and the main control valve are operated by a pneumatic control system. An audible alarm will sound in the engine room when the door to the CO₂ cabinet opens. A switch on this door will at the same time stop the engine room ventilation. The CO₂ system for the cargo holds is operated mechanically, inside the CO₂ room. The main control valve and the closing valves on top of the cylinders are opened manually.

The vessel's fire alarm system further consists of:

- one fire alarm centre on the bridge,
- sixteen smoke detectors placed in the engine room, steering gear room and emergency generator room,
- twelve smoke detectors in the accommodation corridors and bridge,
- nine smoke detectors in deck stores, provision stores, switchboard room, workshop and change room,
- fourteen manual fire alarms at exits,
- six temperature sensors fitted in the messrooms, galley and bridge,
- an alarm on the engine room panel, in the messrooms and in the chief engineer's cabin,
- audible alarm in the engine room.

According to **HBS International** January 2007

Fire-fighting equipment of the passenger/freight ferry ISLE OF INISHMORE

The ship is provided with an addressable fire detection system. Apart from a detail display function on the main unit, the fire is also displayed in mimic format on the SMCS. The status information (open/close) of the fire doors and ventilation fire flaps is integrated in this system. A hard wired repeater panel is provided in the ECR and both harbour control stations. More than 700 detection units are provided.

The vehicle decks are equipped with heat detection cable instead of smoke or heat detection heads. A water sprinkler system is provided for the accommodation area, public spaces, staircases and some stores, ECR and workshop. Except of the ECR, all areas have an automatic release system.

The **CO₂ extinguishing system** protects the machinery spaces, the emergency alternator room and the galley ventilation uptakes. The drencher system protects the car deck spaces. The drencher system is divided in a number of sections, each controlled by a quick-opening manually-operated valve. Complementing fire-fighting equipment includes hoses and hose

Fire-fighting extinguishers

boxes, portable fire extinguishers, fire-fighting outfits, and three fixed **shore connections** for connecting **fire main** to shore.

According to **HSB International**, February 1997

Fire-fighting extinguishers – There are four principal types of portable extinguishers usually found on board a ship. They are soda-acid, foam, dry powder and CO₂ extinguishers.

Soda-acid extinguisher is used for extinguishing solid material fire (Class A fire) and is found in accommodation areas. Foam extinguisher is used for oil fire (Class B fire) and is located in the vicinity of inflammable liquids. Dry powder extinguisher can be used for all types of fire but it has no cooling effect. CO₂ extinguishers are mainly used for Class B and C fires and are found in the machinery space, particularly next to electrical equipment.

Fire main – A sea water supply system for fire hydrants. It consists of sea inlets, suction piping, fire pumps and a distributed piping system supplying fire hydrants, hoses and nozzles located throughout the vessel. Each vessel is to be provided with at least two main **fire pumps**. If the arrangements for the two main fire pumps are such that a fire in one space can put both main fire pumps out of service, an **emergency fire pump** is required to be provided.

Further reading: ABS Guidance Notes on Fire-Fighting Systems,
can be downloaded from www.eagle.org

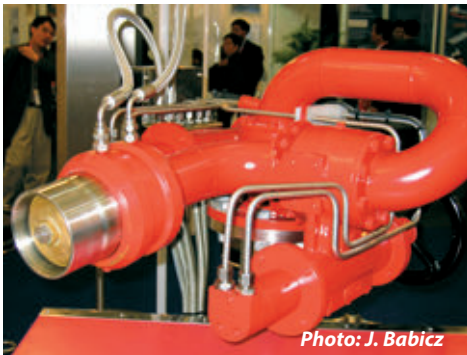

Fire monitor – Fixed foam/powder/water cannon shooting fire-extinguishing agents on the tank deck, manifold etc.

Fire patrol – An inspection through the vessel carried out by a crewmember on the watch at certain intervals so that an outbreak of fire may be promptly detected; mandatory in vessels carrying more than 36 passengers.

Fire pumps – Usually centrifugal pumps with flat or very shallow head/capacity curves. Such pumps are capable of supplying minimal flow rates without creating excessive and dangerous pressures, yet are also capable of providing large flow rates while maintaining the required pressures at the most remote nozzles.

Further reading: ABS Guidance Notes on Fire-Fighting System,
can be downloaded from www.eagle.org

Fire Safety Systems Code – The International Code for Fire Safety Systems as adopted by the Maritime Safety Committee of the IMO by resolution MSC.98(73).

Fire suit – Protective clothing of a fireman.

The Flamequard Mk2 firesuit consists of jacket, trousers, gloves, helmet with visor and neck-protector.

Fire Test Procedures Code – The International Code for Application of Fire Test Procedures as adopted by the Maritime Safety Committee of the IMO, by resolution MSC.61(67).

Fire wall – A wall designed and constructed to remain structurally intact under the effects of fire and insulated so that the temperature on the unexposed side will remain below a specified temperature for a determined amount of time, (ABS).

Fire wire – A wire rigged to the waterline over the off-berth side of a ship to facilitate towing away in emergency.

Fire wires enable tugs to pull the ship away from the pier without the assistance of any crew in case of a serious fire or explosion.

First-ashore line – Usually a fibre line put ashore first to help in hauling the ship into berth.

First Assistant Engineer – The licensed member of the engine department in charge of the four to eight watch. He usually works from eight to four handling engine maintenance. He assigns duties to unlicensed personnel and monitors and records overtime. He consults with Chief Engineer regarding work to be done.

First Mate, Chief Mate – The licensed member of the deck department in charge of the four to eight watch. The Chief Mate is directly responsible for all deck operations: cargo storage and handling, deck maintenance and deck supplies. He assigns and checks deck department overtime. He is also ship medical officer.

Fischer-Tropsch fuel – Synthetic fuel derived from coal, natural gas or biomass.

Fish processing plant of the trawler KAPITAN NAZIN

Fish is vacuum-pumped from the refrigerated sea water tanks (capacity 475m³), where temperature is kept between 2°C and -6°C, to the factory room which is equipped with machines for heading, gutting, skinning and filleting. Two production lines are arranged for the treatment of livers and roe, as they move from the processing area to be prepared, sterilised and packed in the canning factory. A Hetland fishmeal plant handles 150 tonnes of raw fish material daily to produce fishmeal and oil.

Fishery research vessel G.O. SARS

The Norwegian highly-sophisticated research vessel, the G.O. SARS, was delivered on 25 April 2004 from the shipyard Flekkefjord Slipp AS to the Institute of Marine Research. The hull was built in Poland at NAUTA shipyard.

The G.O. SARS is arranged and equipped with state-of-the-art technology in order to carry out a wide variety of research work. Examples of the research work the vessel is capable of carrying out include: pelagic and bottom trawling, plankton sampling, CTD/rosette operations, towed body operations, hydrographic operations, water sampling, miscellaneous kinds of environmental sampling, grabbing and coring, hydro-acoustic research work, and seismic operations.

With its vibration- and noise-damped diesel generators and the propellers driven by direct current motors, "G.O. SARS" is an extremely quiet vessel when under way. It emits 99 percent less noise under water than conventional research vessels. When performing stock-measurements the distance where fish avoid the ship is only 15 m versus the above 200 m previously. In addition the vessel is equipped with two drop keels enabling the sensitive instruments to be lowered 3-4 m below the bottom of the vessel, and thus will have optimal working conditions.

The vessel has more than 20 laboratories and special rooms for scientific work. Since the vessel also shall operate in northern cold waters, the solutions onboard are designed for this

FISHERY & OCEANOGRAPHIC VESSEL R/V G.O. SARS

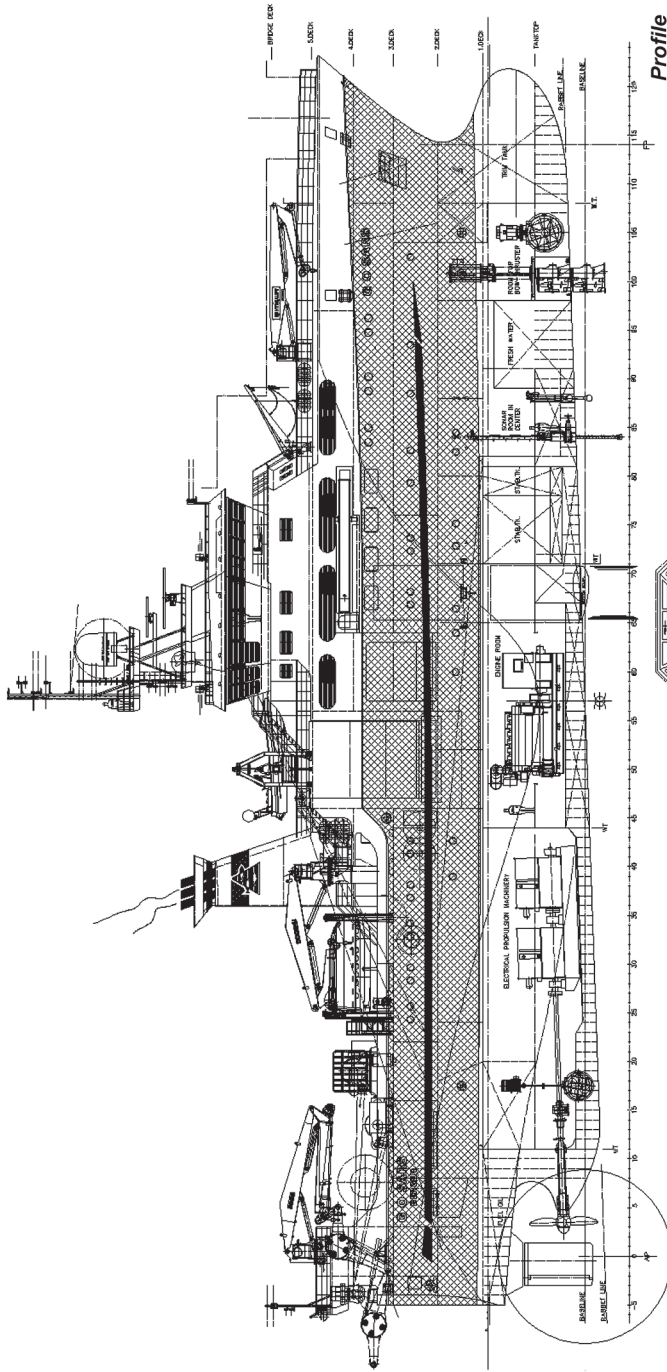

Profile

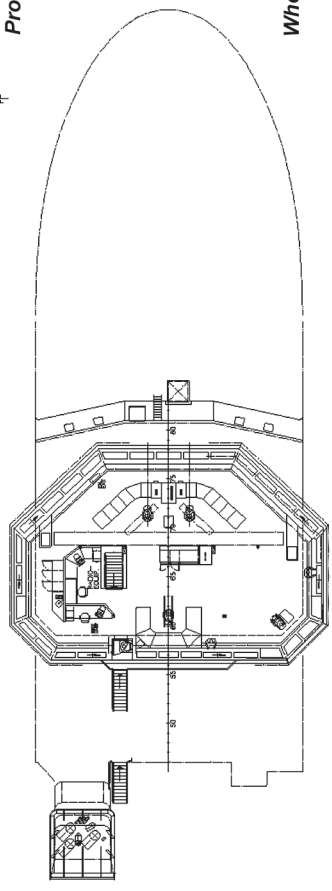

Plans courtesy of Skipsteknisk
www.skipsteknisk.no

Wheelhouse

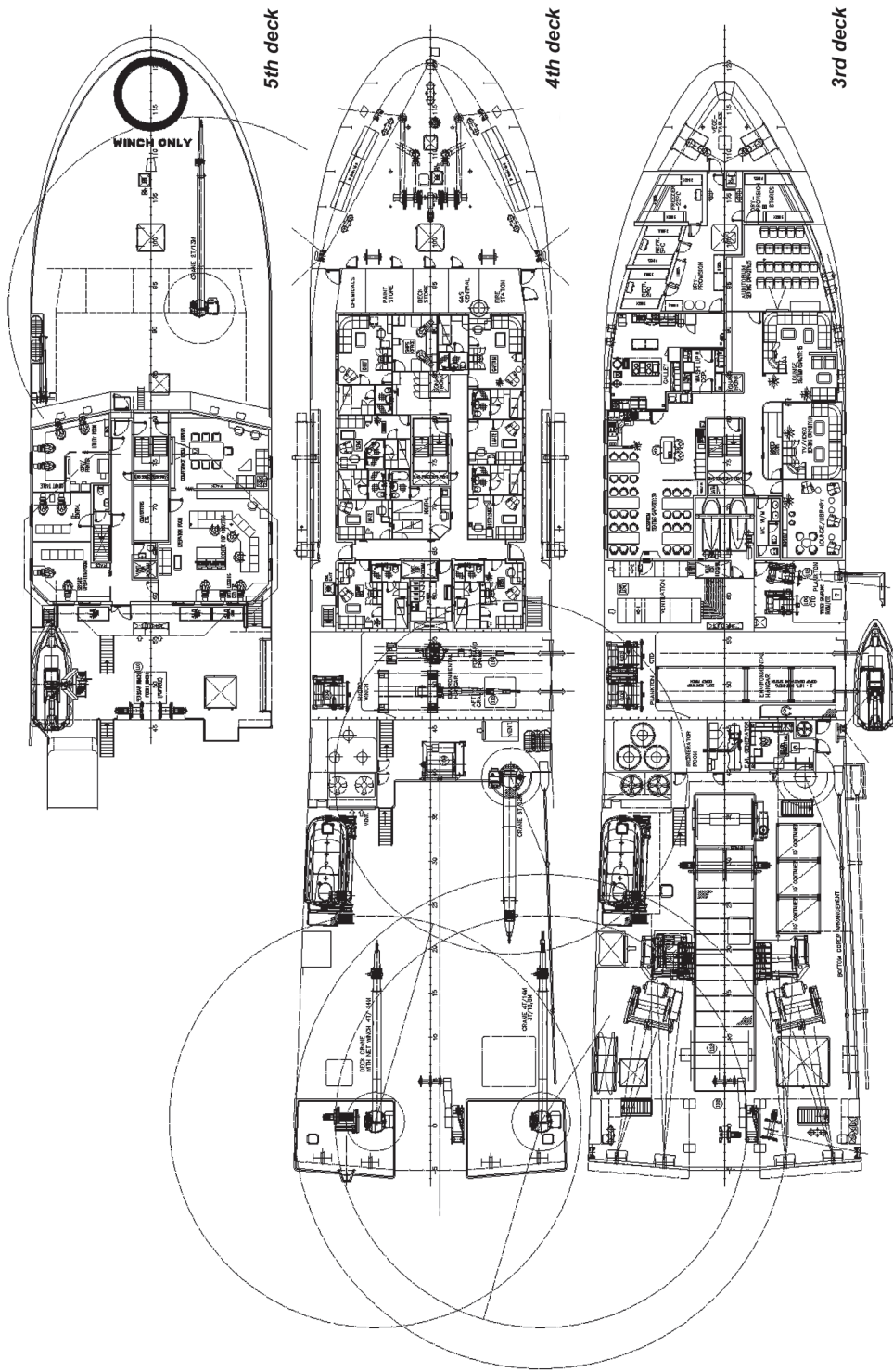

$L_{OA} = 77.5\text{m}$, $L_{BP} = 68.40\text{m}$, $B_{MLD} = 16.40\text{m}$, $DRAUGHT = 6.20\text{m}$

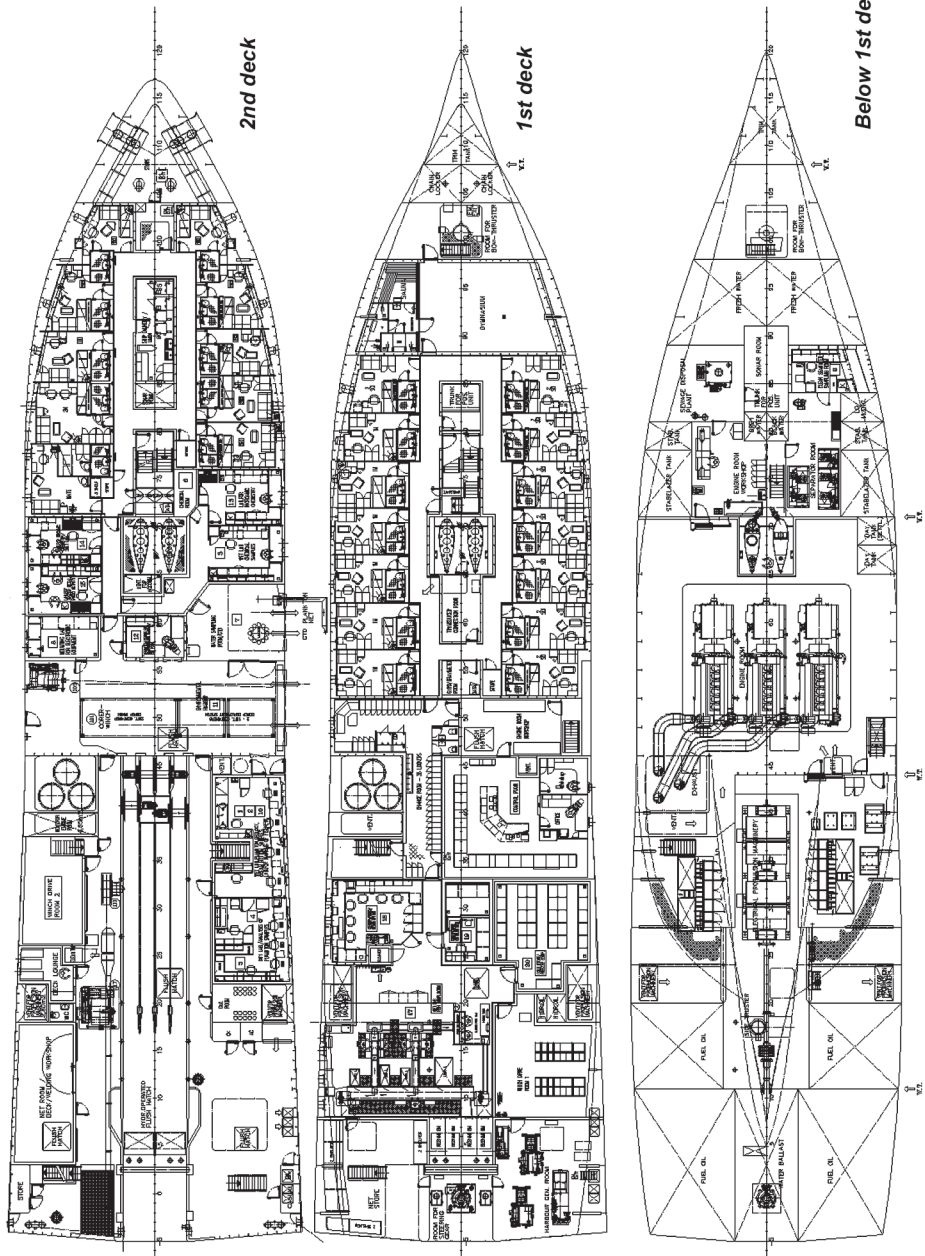

Photo courtesy of Wärtsilä Corporation



operation. Most research operations, except for the fishery part, will be performed from the environment hangar and the CTD hangar amidships. They are closed heated hangars with side gates. Here all preparation and complementary work may be executed comfortably and under shelter, and the crew is only exposed to weather during the sampling itself.

The vessel is equipped with dynamic positioning system, and this system simplifies to a great extent the challenge of keeping the vessel in the set position during sampling, which in turn improves the accuracy and quality of the samples.

The G.O. SARS is built with a diesel-electric propulsion system not only because of better operation economy, but also because of the noise requirements. The propulsion engines are based on D.C. as frequency converters are likely to make too much noise. For the same reason, the ship is not equipped with a gearbox, but has direct running of propeller from the motors. The propulsion system has a capacity of 6000 kW. The power supply is generated from three diesel generators, type Wärtsilä 6L32, each with an output of 2700 kW.

Moreover the vessel is equipped with electric winches. This solution is supposed to offer the best operating result in course of time. In addition, this solution implies that hydraulic pipes are replaced by electric cables, and the risk for leakage in the hydraulic system is eliminated. Thus a very tidy and clean solution onboard is achieved.

The G.O. SARS will have a crew of 45 persons – 30 scientists and 15 crewmembers. In accommodation, the crew well being and environment are emphasized with large common areas including a well-equipped gymnasium with sauna. It is used by researchers from the University of Bergen and IMR working both independently and together.

Before the delivery of the "G.O. SARS" SKIPSTERNISK AS has designed two super silent research vessels and all two fulfill ICEC noise requirements. The first of them is the Scottish research vessel "Scotia" delivered in 1998. The second is the Irish research vessel, the "CELTIC EXPLORER".

Fishery research vessel CELTIC EXPLORER

According to **Significant Small Ships** of 2003

The multi-purpose research vessel CELTIC EXPLORER was designed by SKIPSTENKISK AS and delivered in December 2002 by Damen Shipyards Gorinchem for the Irish Marine Institute. Ireland has one of the largest offshore areas in Europe. Its unique strategic position in Europe, at the edge of the Atlantic, means that the new vessel will facilitate both national and international research and exploration.

The vessel is outfitted and prepared for such duties as fishery, acoustic, and environmental research operations as well as seabed mapping. Silent operation is crucial for vessels engaged in fishery research. The currently accepted standards are set out in Report 209 of the International Council for Exploration of the Sea (ICES). CELTIC EXPLORER is claimed to be the first vessel in the world to comply with ICES 209 in the required sound frequency range between 10Hz and 63kHz.

A sophisticated low noise diesel-electric propulsion system has been specially developed with the assistance of Dutch specialist Bakker Sliedrecht Electro Industries An extremely low-noise FP propeller of 3200mm-diameter is directly driven (without gearbox) by two direct current, low- speed electric motors coupled in tandem. Each of the low-noise DC motors has a maximum power rating of 1500kW at 180rev/min. The motors are fed and controlled by two Bakker custom built digital drives in a semi 24-pulse configuration together with two double winding transformers with an extra low-noise mode. The vessel can achieve a maximum speed of 15.5 knots at 100%MCR.

Power generation for the propulsion system and the main electrical supply is provided by three Wärtsilä diesel engines coupled to Indar generators. Two Wärtsilä 9L20 powered generators produce 1620kW each and a Wärtsilä 6L20 drives a 1080kW generator, all at 690V. Two thrusters are also important part of the propulsion system. An Elliot Gill pump-jet powered by a 720kW electric motor is installed in the bow and delivers a maximum omnidirectional thrust of 6.2t. A transverse tunnel thruster in the stern has a CP propeller and is powered by a 400kW motor.

The ship is fitted with a comprehensive array of winches and deck equipment enabling the vessel to handle a wide range of fisheries research equipment and nets, towed hydrographic sensors, and also to carry out other marine tasks over the stern. Eleven winches of Rapp Hydema AS make are installed on the vessel. Fishing operations are controlled by a sophisticated trawl winch and handling system with autotrawl displays and controls on the bridge. Two 30t split trawl winches located on the main work deck are each fitted with 3500m of wire and have a maximum line pull of 30t at 78m/min. A pair of 12t Gilson winches is located at the bridge level. Three net drum winches are provided, two rated at 35t line pull and one at 45t is fitted for towing purposes and incorporates a constant tensioning system. The trawl gantry operates in conjunction with a 5.6t net-sounding winch accommodating 3200m of 11mm diameter wire.

Three hydraulically operated deck cranes are provided: one elbow derrick crane 6t/15m, one 8t/15m and one telescopic derrick crane 2t/8m. The stern-mounted A-frame has lifting capacity of 25t, and a lifting frame with "T" configuration can lift 10t and is located on the starboard side of the main work deck.

In order to assist the deployment of scientific transducers, a retractable fin keel is provided just forward of amidships. The keel is located in an enclosed vertical steel trunk and can be raised or lowered by means of an electrically powered winch controlled from the bridge.

The facilities for scientific staff onboard include four well-equipped chemical laboratories, wet fish research, water sampling and dry procedures. A purpose-designed IT room is included and a dedicated scientist office and meeting room. A provision is made to accommodate additional scientific equipment in laboratory containers on deck.

RESEARCH VESSELS

Ship	CELTIC EXPLORER	G.O.SARS	MARIA S. MERIAN	JAMES COOK
Shipyard	Damen Gorinchem	Flekkefjord Slip & Maskinfabrik Nauta Shipyard Gdynia	Kroeger Werft Maritim Gdańsk Naval Shipyard Gdynia	Flekkefjord Slipp & Maskinfabrik AS. Crist Gdańsk
LOA	65.50m	77.50m	94.80m	89.20m
LBP	58.20	68.40m	88.20m	78.00m
B (Beam)	15.00m	16.40m	19.20m	18.60m
D (Depth)	8.40m	9.10m		9.50m
Draught design	5.65m	6.20m	6.50m	5.60m
Deadweight	957tonnes	1308tonnes		
Gross tonnage	2425	4067		5365
Net tonnage	727	1220		1610
Service speed	15.5 knots	17.50 at 5.8m	15 knots	16 knots
Propulsion system	Diesel-electric	Diesel-electric	Diesel-electric	
Engines	2x Wärtsilä 9L20 1x Wärtsilä 6L20	3x Wärtsilä 6L32	MAN B&W 2x1600kW 2x1200kW	4x Wärtsilä 9L20
Range	45 days		35 days	
Personnel	31	45	40	

Further information can be found on www.skipsteknisk.no

Fishery patrol vessel, also fishery inspection vessel – A vessel that carries out control duties in the fishery zone outside coastal waters.

Fishing gear, fishing equipment – Any physical device or item that may be placed on or in water with the purpose of capturing, or controlling for subsequent capture, living marine or freshwater organisms.

Fishing methods – There are three main ways of catching fish:

- by towing trawls or dredges,
- by surrounding fish by nets,
- by static means.

Accordingly different types of fishing equipment are used:

- towed or dragged gear: bottom trawling, mid-water trawling, dredging, seine netting,
- encircling gear: purse seining, encircling gill nets,
- static gear: set gill nets, drift gill nets, long lines, lift nets, pots and fish traps.

Bottom fishing (demersal) is carried out by towing a large, conical net (trawl) near the sea bottom. Three typical net configurations are used: side trawling, beam trawling and stern trawling. The following methods are used for surface fishing (pelagic); purse seining, pair seining, gill netting, long lining, hand lining, rod lining and midwater trawling.

Fishing vessels – Vessels specially equipped for catching and storing fish, whales, seals, walrus or other living resources of the sea. See also **Purse seiner/trawler LIBAS**.

Fixed fire fighting systems, also fixed fire-extinguishing installations – Carbon dioxide systems, **foam systems**, halon systems, inert gas systems, water-spraying systems.

Fixed installation – A bottom-founded offshore facility permanently secured to the sea floor. The term includes, but is not limited to, fixed platforms, guyed towers, jack-ups, etc.

Fixed-chain drive – A fixed chain along which a hydraulic motor and sprocket can crawl, driving the hatch cover along the coaming.

Fixed Water-Based Local Application Fire Fighting System (FWBLAFFS) – A water-based fire-fighting system required by SOLAS 2000-Amendments Regulation 10.5.6 and MSC/Cir. 913 in order to provide early suppression of a fire in machinery space Category “A”. The main idea behind local protection is the immediate application without having to evacuate space, stop ventilation, close openings, etc. Once the system has been started all these measures required before the release of the main fire fighting system can be taken.

In principle, fire-fighting systems such as high/low-expansion foam systems, water spray, high/low-pressure water mist system may be used. The use of seawater, though not prohibited, is not desirable due to increased corrosive potential.

Flag of convenience – The registration of ships in a country whose profit tax for trading ships is low or whose requirements concerning manning or maintenance are not stringent.

Flaking – Lifting the paint from the underlying surface in the form of flakes or scales.

Flame arrester, also flame arresting device – A permeable matrix of metal, ceramic or other heat resistant material which can cool a deflagration flame, and any products of combustion, below the temperature required for the ignition of the flammable gas on the other side of the arrester.

Flame detector – A device, which can detect the ultra-violet or infrared rays given off by a flame. It is used as **fire detector** near to fuel handling equipment and at boiler fronts.

Flame inhibitors – Materials, which interfere chemically with the combustion process, and thereby extinguish the flames. Cooling and removal of fuel is necessary to prevent re-ignition.

Flame screen – A portable or fixed device incorporating one or more corrosion resistant wire woven fabrics of very small mesh which is used for preventing sparks from entering a tank or vent opening or, for a short time, preventing the passage of flames.

Flame speed – The speed at which a flame propagates along a pipe or other system.

Flame trap – A gauze or perforated metal cover over an opening or vent to prevent the passage of flame.

Flameproof – An enclosure for electrical equipment which must withstand an explosion of any gas or vapour that enters. No damage must occur and no flammable matter must escape. This type of enclosure is used in dangerous spaces.

Flammability limits – The conditions defining the state of fuel-oxidant mixture at which application of an adequately strong external ignition source is only just capable of producing flammability in a given test apparatus (IBC Code).

Flammable, also combustible – Capable of being ignited and burnt.

Flammable fluid – Any fluid, regardless of its **flash point**, capable of feeding a fire. Aviation fuel, diesel fuel, hydraulic oil (oil based), lubricating oil and hydrocarbon, are considered flammable fluids.

Flammable range – A mixture of hydrocarbon gas and air cannot ignite unless its composition lies within a range of gas in air concentration known as the “flammable range”. The lower limit of this range, known as the “lower flammable limit” is any hydrocarbon concentration below, with insufficient hydrocarbon gas to support combustion. The upper limit of the range, known as “the upper flammable limit” is any hydrocarbon concentration above, with insufficient air to support combustion.

Flange -

1. The part of a plate or shape bent at right angles to the main part.
2. A circular metal plate with holes formed or fitted on the ends of pipes in order to couple them together.

Flare -

1. An outward curvature of the side shell at the forward end (**bow flare**) above the waterline.
2. A night distress signal, (rocket parachute flare, hand flare).
3. A device which disposes unwanted oil or gas by burning.

Flashpoint – The lowest temperature at which a liquid gives off sufficient vapour to form a mixture with the air near its surface which, if ignited, will make a small flash, but will not catch fire. It is measured under standardized conditions.

Flat – A minor section of internal deck often without sheer or camber, also known as a platform.

Flat welding position – The welding position used to weld from the upper side of the joint at a point where the weld axis is approximately horizontal, and the weld face lies in an approximately horizontal plane.

Fleet angle – The angle between the **mooring line** and a plane perpendicular to the axis of the winch drum.

Flettner rotor – Unconventional ship propulsor based on the Magnus effect. Flettner rotor is a vertical cylinder rotated around its axis by a motor. As wind blows past the rotating cylinder, high pressure on one side is formed with a corresponding low pressure area on the opposite side. This pressure difference generates a lift force perpendicular to the wind’s direction. There is also a drag force. The forward components of these forces result in thrust driving the ship forward. A Flettner rotor has about 10 times more lift with the same “sail” area than normal soft sails.

Flexible coupling – To reduce vibration in a geared drive, the flexible coupling needs to be fitted between the engine and gearbox. It allows for some misalignment and controls the torque variations within the system.

Flexible pipelaying vessel SEVEN SEAS

SEVEN SEAS has been designed by Merwede Shipyard in close co-operation with Subsea 7 and the Huisman-Itrec. The vessel is intended primarily for flexible pipelaying operations with an additional J-lay capability. The multipurpose lay-tower is situated aft of the ROV hangar and accommodation block. It consists of two aligner chutes, one on port and one on starboard and an enclosed welding station for J-lay operations. The tower is equipped with an electrically driven upper 170t flex tensioner and electrically driven main tensioner with a 200t flex-rating and 400t rigid-rating. In both flex and J-lay mode up to 24» diameter pipe can be deployed. A 450t and a 125t A+R winch are provided.

Photo courtesy IHC Merwede



SEVEN SEAS

The midbody of the SEVEN SEAS incorporates a large **moonpool** (7x7.5m). It is closed by sliding hatches at deck level; the hatches have a hang off capacity of 600t SWL. The moonpool's hinged bottom door is constructed in such a manner that it streamlines the flow under the vessel whilst sailing. In open position, the door forms part of a damping cofferdam structure that prevents surge in the moonpool during operations.

Aft of the moonpool, a hold has been arranged to accommodate two carousels, each with an external diameter of 16m and capacity of 1250t. On the main deck there is an open deck area of 1750m², with a deck load capacity of 10t/m² or a deck carousel up to 24m diameter and 3000t capacity, where reel drive system can be located.

The diesel-electric power plant features six Wärtsilä gensets of 3360kW/3600kVA each. The emergency/harbour genset consists of a 1500 kWe (440V, 60Hz) Volvo Penta D65 A MS engine and AvK type DSG 86 M1-4 generator. Propulsion and dynamic positioning DP2 is established by means of three 2950kW azimuth stern thrusters, two 2400kW retractable azimuth bow thrusters, a 2200kW bow thruster – all Wärtsilä – and a Kongsberg Simrad SDP 22 DP system.

Length, oa: 153.24, Length, bp: 138.22m, Beam, mld: 28.4m, Depth, mld to the main deck: 12.5m, De-sign draught: 7.5m, Deadweight, design: 11,130dwt, Output: 6x3360kW, Main propulsors: 3x2950kW azimuthing thrusters + 2x2400kW retractable bow thrusters, Service speed: 13.0knots, Accommodation for 120 persons.

Floatability – The ability of the vessel to support any weight by means of the hydrostatic pressure acting on the underwater surfaces, giving rise to the **buoyancy** force.

Float-free launching – A method of launching a **survival craft** whereby the craft is automatically released from a sinking ship and is ready for use, (**SOLAS**, Chapter III).

Floating booms – Equipment employed in spill recovery. Floating booms are used not only for containment of oil but also for deflecting oil away from sensitive areas.

Floating Installation – An offshore facility designed to provide hydrocarbon processing and/or hydrocarbon storage and offloading hydrocarbons. The term includes **Tension Leg Platforms, Spar Buoy**, Permanently Moored Shipshape Hulls and **Semisubmersibles**. A Floating Installation consists of the following major elements: **Floating Installation Vessel, Position Mooring System**, and Production Facilities, Import/export system.

Floating Installation Vessel – A floating structure and the machinery, equipment, and systems necessary for safety, propulsion (if fitted), and auxiliary services. The structural configurations of these vessels may be ship-shaped, column stabilized, or any other configuration of a purpose-built floating vessel.

Floating oil storage – Oil stored on floating vessels. It has been the practice for oil to be stored in large laid-up oil tankers in order to set off the loss while the tankers are inactive.

Floating production, drilling, storage and offloading (FPDSO) offshore unit – A novel FPSO that incorporates a drilling facility. The drilling takes place through the turret moonpool from a rig supported directly by the vessel.

Floating production, storage and offloading units (FPSOs) – Semi-submersibles or ship-type offshore mobile units used for exploitation of marginal fields. FPSO provides hydrocarbon processing, storage, and offloading hydrocarbons. The unit can be relocated, but is generally located at the same place for long time. It normally consists of a hull with turret, production equipment on deck, crude oil storage facilities and offloading arrangement. Tanker-type FPSOs, including multipurpose models able to operate as **shuttle tankers** and perhaps even drilling if required, are proving a popular class for operators seeking cost-effective hulls for either deep-water or small oil and gas fields.

The main aim in the FPSO design is to optimise sea-keeping and stability in severe weather, in order to guarantee uninterrupted operation in extreme weather conditions.

Floating production, storage and offloading unit VARG

According to **The Motor Ship** November 1998

Turret-moored FPSO vessel built by Keppel Fels Singapore for the Varg Field in Norwegian sector of the North Sea. The 16 m-diameter **turret** is located forward of the midships area in order to provide a passive weathervaning capability. The turret bearing system has roller bearings above the main deck level to accommodate both vertical and horizontal forces. The turret is turned via a rack and pinion system driven by electric motors. As the wellstreams are manifolded at the nearby wellhead platform at the field, there is no manifold in the turret. Fluid and utility transfer between the turret and the ship is accomplished via a drag chain system based on tiers of armoured flexible hoses and cables arranged within a structure atop the turret. Hard piping connects each fixed end of the flexible to turret and to post on the vessel. This system allows the drag chain to wind and unwind around "0" mounted trolleys.

The process plant is capable of processing 13,000 m³/day of liquids, and the production of 9000 m³/day of oil and 9000 m³/day of water respectively. The gas production and reinjection systems have a capacity of 1.5 million m³/day at 350 bar, while the capacity of the water injection system is 16,000 m³/day at 230 bar. The process plant also comprises major systems such as the chemical injection equipment, a heating medium, cooling medium, sand removal equipment, and the fuel gas and flare gas system.

Floating production system (FPS)

VARG has total storage capacity of 75,000m³ and two slop tanks. Crude is offloaded from VARG to tandem-moored shuttle tankers using deep-well pumps, at a rate of 4000 m³/h, via the offloading arrangement.

Length, oa: 214.00m, Length, bp: 200.00m, Breadth, mld: 38.00m, Design draught; 16.00m, Deadweight approx. 100,000dwt.

Floating production system (FPS) – Semi-submersible or ship-based system used to exploit the oil fields. The system has three main components: the Floating Production Vessel (FPV); Mooring System and Subsea System, which include the risers and well system. FPS processes and offloads hydrocarbons without storing them.

Floating Production Vessel – The FPV consists of a large deck connected to submerged pontoons by widely-spaced surface-piercing columns. The pontoons provide buoyancy to support platform weight. The columns provide floating stability and structural strength, and the deck supports the drilling, production, accommodation and marine facilities.

Mooring system – To drill and produce, the FPV requires a robust and highly-reliable station keeping system which is generally a chain or wire/chain catenary-spread mooring system.

Subsea System – This system conducts well fluids (oil, gas and water) from the reservoir to the FPV. Fluids are separated and stabilised by the process facilities on the FPV and exported, generally by a separate riser system and subsea pipelines.

***Further reading:** ABS Guide for “Floating Production Installations”, can be downloaded from www.eagle.org*

Floating storage and offloading unit (FSO) – An offshore unit equipped for crude storage and offloading to a **shuttle tanker**. Oil from a floating production unit is transferred by a flexible **riser** and a swivel through the **turret**. The main electrical power is also supplied through the turret from cables and slip-ring unit (the FSO is normally unmanned, with operation carried out by telemetry). Offloading from FSO to **shuttle tanker** is done through a flexible hose in the stern. When offloading operations are in progress, an azimuthing stern thruster ensures that the hull remains in the correct heading. The rise of the monohull **floating production, storage and offloading unit** with its onboard storage capacity has reduced the scope for separate FSOs.

An FSO stores and offloads hydrocarbons without hydrocarbon processing facilities.

Flocculation – A process by which two or more particles aggregate without losing their individual identities.

Flood control doors, also flood prevention doors – **Watertight** doors provided to increase the damage stability of the **ro-ro** ship by restricting the movement of any water along the deck and therefore reducing the free water surface area. Flood control doors divide a vehicle deck into separate sections to limit the extent of flooding. Different types are in use, each adapted to specific needs: side-stowed jalousie doors; top-stowed jalousie doors; side-rolling doors; and hemicyclic doors.

Sliding link doors – The sliding link doors comprise three panels. In the stowed position, the door is placed along the side or along the centre line casing. When the door is closed, the sections run on a track, which is radius, shaped at the ship side and then transversely across the ship. The panels are powered by a hydraulic motor with rack and pinion or by jigger winches with wire. The joints between sections are hydraulically-locked when the door is in the closed position to allow it to take horizontal load.

Concertina door – A vertical curtain door. It consists of a number of aluminium profiles shaped and dimensioned to be connected along the edges in a zigzag configuration. In use, the door's storage cassette is lowered from its stowed position under the deck to the floor and the profiles are drawn out to form a "**corrugated**" bulkhead.

Floodable length – The floodable length at any point in the length of the ship is the maximum portion of the length, having its centre at the point in question, which can be symmetrically flooded at the prescribed permeability, without immersing the **margin line**. The floodable length of a vessel varies from point to point throughout her length and is usually the greatest amidships and the smallest near the quarter length.

Flooding – The uncontrolled entry of seawater into a tank or compartment as a result of damage.

Flooding of the car decks has been acknowledged as the most dangerous problem for a ro-ro vessel.

Progressive flooding – Ingress of water to compartments assumed to be intact. Such additional flooding may occur through internal openings or through non-watertight external openings and pipes if they are located below the **waterline** after damage. The possibility of progressive flooding through ballast piping passing through the assumed extent of damage, where positive action valves are not fitted to the ballast system at the open ends of the pipes in the tanks served, is to be considered.

Floor – A bottom transverse member mounted in the double bottom to support the inner bottom plating, can be watertight, solid or a bracket construction.

Plate floor, solid floor – Transverse, vertical plate extending from the bottom shell to the inner bottom, usually with large holes for access and weight saving.

Flue gas economizer – A preheater arranged in the flue gas duct of boiler used for preheating of feedwater with no steam produced.

Flue gas system – If available, flue gas from ship boilers can be used for inerting. The flue gas system washes and cools the boiler flue gas, and delivers it to the cargo tanks during cargo unloading and tank washing. As the flue gas already contains less than 5% oxygen no further treatment is necessary. This system is primarily used on crude oil tankers. The main components are: the scrubber unit, inert gas blowers, the deck water seal, the pressure/vacuum breaker, valves, instrumentation and the control system. Surplus gas is automatically re-circulated to the scrubber unit. The system can also be preset to deliver fresh air for gas-freeing purposes.

Flue gas system with topping up generator – It consists of a flue gas system supplemented by a separate small (500 Nm³/h) inert gas generator. The flue gas system covers the bulk of the inerting during cargo unloading, and the topping up generator tops up tank pressures during the sea voyage.

Fluid – A liquid, a gas or combination thereof.

Corrosive fluids – Corrosive fluids, excluding seawater, are those possessing in their original state the property of being able through chemical action to cause damage by coming into contact with the ship or its cargo, when escaped from their containment.

Toxic fluids – The fluids that are liable to cause death or severe injury to human health if swallowed or inhaled or by skin contact.

Flume – A **roll stabilisation** system using an **athwartships** tunnel or tank connecting two wing tanks. The water movement is out of phase with the rolling motion and creates a moment which counteracts the roll.

Flush deck ship – A ship that has no **superstructure** on the **freeboard** deck.

Flux-cored arc welding (FCAW) – An arc welding process that uses an arc between a continuous filler metal electrode and the weld pool. The process is used with shielding gas from a flux contained within the tubular electrode, with or without additional shielding from an externally supplied gas, and without the application of pressure.

Flywheel – A large disc or wheel fitted to the crankshaft of an **internal combustion engine**. It acts as a store of kinetic energy to reduce speed variations when the engine is running.

Foam, also froth – An aerated solution that is used for fire prevention and fire-fighting. Foam is an efficient agent for extinguishing most liquid petroleum fires. Foams are divided into low, medium and high ranges of expansion.

Low-expansion foam – Expansion in volume of up to 20 times of the quantity of water used.

Medium-expansion foam – Expansion 20-200 times.

High-expansion foam – Expansion 200-1000 times.

Foam concentrate – The full strength liquid received from the supplier, which is diluted and processed to produce foam. When using portable foam making equipment the concentrate is usually introduced to the system directly from the 25 litre storage drums.

Foam extinguishing systems – Fixed, low- and high-expansion foam systems are permitted in the machinery spaces and fixed, low-expansion systems are required on cargo tank decks of tankers.

Foam solution – The mixture produced by diluting **foam concentrate** with water before processing to make foam.

Foam system – A foam system has a storage tanks containing **foam concentrate**. The water from the fire pumps picks up the correct proportion of foam concentrate from the tank through a proportioner and the **foam solution** is then carried through permanent supply lines to off take points.

Folding cover – Any variety of hatch cover, which hinges and folds during opening. See also **hatch covers**.

FORAN – CAD/CAM/CIM system from Spanish consulting and engineering house Sener.

Force – Acceleration or retardation of the mass results from an applied force. When unit mass is given unit acceleration then a unit force has been applied. A unit force is the **Newton** (N).

Force Majeure – The title of a standard clause in marine contracts exempting the parties (shipyards, charterers, shippers and receivers of cargo) from nonfulfillment of their obligations as a result of conditions beyond their control, such as earthquakes, floods, or war.

Fore peak – The watertight compartment situated forward of the collision **bulkhead**.

Fore-and-aft – In line with the length of the ship; longitudinal.

Forecastle – A **superstructure** which extends from the **forward perpendicular** aft to a point which is forward of the **after perpendicular**. The forecastle may originate from a point forward of the forward perpendicular, (ICLL). Usually the forecastle is a short superstructure situated at the bow.

Forecastle deck – A deck forming the upper boundary of a forecastle.

Forefoot – The lower end of a ship's stem which curves to meet the keel.

Forest products – Packaged timber, pulp, board, newsprint, lightweight coated (LWC) paper, baled waste paper.

Forging – Steel worked to a desired shape by hammering while extremely hot.

Forklift track – A machine used to pick up and move goods loaded on pallets or skids.

Formal safety assessment (FSA) – FSA is a rational and systematic process for assessing the risks associated with shipping activity and for evaluating the costs and benefits of options for reducing these risks. Application of FSA may be particularly relevant for proposals for rules and regulatory measures which have far-reaching implications in terms of costs to the maritime industry or the administrative or legislative possible burdens. This is achieved by providing a clear justification for proposed measures and allowing the comparison of different options of such measures to be made. This is in line with the basic philosophy of FSA as it can be used as a tool to facilitate a clear decision-making process. In addition, it provides a means of proactivity, enabling potential hazards to be considered before a serious accident occurs.

Forward – At or in the direction of the bow. Also the fore part of the ship.

Forward perpendicular – A vertical line through the intersection of the foreside of the stem with the **waterline** on which the length is measured.

Forward shoulder – The part of a ship where entrance region meets the parallel middle body.

Foul of anchor – Anchor cable is twisted around or it has been fouled.

Foul of propeller – A line, wire, net, etc., is wound round the propeller.

Fouling – A term used to describe the growth of marine plants and animals on man-made structures in the sea.

Fouling roughens the hull, resulting in increased friction of water, which leads to a loss of speed.

Fossil fuel – Any naturally occurring organic fuel formed in the earth's crust.

Fracture – The propagation of a **crack** through the thickness of a material. It may be further described by nature of the surface at the break, e.g. brittle fracture.

Brittle fracture – A break in a brittle piece of metal which failed because stress has exceeded cohesion. Brittle materials crack without significant deformations of the crack surfaces that retain a shiny and smooth appearance.

Ductile fracture – A crack in a material that behaves in a ductile manner. This is characterized by significant deformations of the fractured surface.

Frame – A term used to define one of the **transverse** members that constitute the riblike part of the skeleton of a ship. The frames act as stiffeners, holding the outside plating in shape and maintaining the transverse form of the ship.

Frame spacing – The fore-and aft distance, heel to heel, of adjacent transverse frames.

Framing system – Arrangements of stiffeners used to support hull plating. Two different types of framing are in general use or may be combined. They are longitudinal, transverse and combined framing.

Free surface effect – When a tank is partially filled, the liquid's centre of gravity position will change as the ship is inclined. Liquid in partially filled tank always decreases the initial **metacentric height** GM, righting lever GZ, and angle of vanishing stability.

A partially filled tank is known as a "slack tank". The reduction of stability caused by the liquids in slack tanks is known as free-surface effect. This adverse effect on the stability is referred to as a "loss in GM" or as a "virtual rise in vertical centre of gravity KG" and is calculated as follows:

Loss in GM due to free surface effects (in metres) = Free surface moment (tonnes metres) x Specific gravity of liquid in tank/Displacement of vessel in tonnes

The free-surface effect can endanger the ship or even lead to a negative metacentric height. Therefore the number of partially filled tanks should be kept to a minimum. When ballasting the vessel, only one transverse pair or a single centerline ballast tank should be filled up. At sea, as far as possible, ballast tanks shall be 100% full or empty. When ballasted, wide double bottom tanks must be always 100% full.

Freeboard – Freeboard is the distance measured from the **waterline** to the upper edge of the deck plating at side of the freeboard deck amidships.

Ships must have a **load line mark** located **amidships** on both sides to indicate the maximum allowable draught under specified conditions (geographical and seasonal).

The **International Convention on Load Lines** 1966 (ICLL 1966) with its Protocol of 1988 is a comprehensive set of regulations to determine the minimum allowable freeboard and defines the conditions of load line assignment. The minimum geometric summer freeboard is computed by taking a freeboard for a standard ship of the same length (provided in tabular form) and correcting it for those geometric properties of the ship which differ from those of the standard one. There are corrections for block coefficient, depth, superstructure, trunks and sheer. The result of this calculation – the load line mark – is permanently marked on the ship hull.

The calculation of the minimum freeboard must be approved by a **classification society** which defines the eventual location of the load line marks based on the measurement of built vessel. Marks cannot be welded to the sides of the hull during construction, even if certain shipyards would be eager to do that.

The assignment of the computed freeboard is conditional upon the prescribed means of protection and closure of openings such as hatchways, doorways, ventilation, air pipes, scuppers and discharges being complied with. Regulations are also included for freeing ports in bulwark to prevent water accumulating on deck, as well as guard rails and walkways to provide safe passage.

Freeboard deck – Normally, the uppermost complete deck exposed to weather and sea, which has permanent means of closing all openings in the weather part thereof, and below which all openings in the sides of the ship are fitted with permanent means of **watertight** closing, (LL).

Freeboard mark – see **Load line mark**.

Freeboard Plan – A set of drawings showing external openings (cargo hatchways, small hatches, ventilators, air pipes, side scuttles and windows, **weathertight doors**, scuppers and sanitary discharges, sea inlets and outlets) and details of their closing appliances.

Free-fall acceleration – The rate of change of velocity experienced by the occupants during launching of a **free-fall lifeboat**.

Free-fall certification height – The greatest launching height for which the **lifeboat** is to be approved, measured from the still water surface to the lowest point on the lifeboat when the lifeboat is in the launch configuration.

Free-fall launching – A method of launching a **survival craft** whereby the craft with its complement of persons and equipment on board is released and allowed to fall into the sea without any restraining apparatus, (SOLAS, Chapter III).

Free-fall lifeboat – A lifeboat constructed for **free-fall launching**. The certificate of approval for a free-fall lifeboat shall state **free-fall certification height**, required **launching ramp length**, and **launching ramp angle** for the free-fall certification height.

The free-fall lifeboat concept first came to light in 1897 when Swedish designer A.E. Falk patented a blueprint of an enclosed lifeboat capable of sliding off a ship stern. Thirty years later, the Bay and River Navigation Company's Capt White proposed a "unsinkable submarine lifeboat". It wasn't until 1977 that the maritime world witnessed the first manned-launch of free-fall lifeboat from the stern of the m/s TARCOOLA at Oresundsavarvet Shipyard.

The benefits of free-fall lifeboat are clear: during rapid evacuation in emergencies, the boat slides out from a ramp onboard the ship/installation and hits the water well away from the ship or installation with a high positive forward motion. Passengers are safe and secure in an enclosed cabin, safely strapped to anatomically-shaped seats. The lifeboat system is robust and can withstand high winds, powerful waves and extreme weather conditions. Makers state that testing boats in free fall do not affect the structural condition and claim that some boats have been dropped over 2000 times without significant damage.

To recover the free-fall lifeboat two solutions can be adopted: an integral recovery system or a simple ramp and a combined lifesaving and provision crane. Integral recovery system consists of a pivoting A-frame that sits above the sliding ramp and is moved by two hydraulic cylinders. A wire rope engages the boat and lifts it to the required height before the A-frame is pivoted inboard to drop the boat into the correct position. However, a free-fall craft cannot be used as rescue boat, so a six-man rescue boat is required in addition to the lifeboat.

Note: For safety reasons it is not acceptable to carry inherently buoyant lifejackets during free-fall launching so all occupants of free-fall lifeboats are to be provided with approved inflatable lifejackets, which can be worn when launching.

Free-fall of liquid – The unrestricted fall of liquid into a tank.

Freeing port – An opening in the lower portion of a **bulwark** which allows water shipped on deck to run freely overboard.

Freezing point – A temperature at which a liquid solidifies under controlled conditions.

Freight – A sum of money paid for the hire of a ship or for carrying goods by sea.

Freight ferry CONTENTIN

CONTENTIN has been built at the Aker, Helsinki shipyard for UK/France service. The large superstructure at the fore end of the upper deck contains 121 two-berth cabins with en-suite facilities for drivers, together with dining and leisure services. The vessel can accommodate 120 articulated trucks or similar vehicles on three decks, utilising 2200 lane metres. Clear deck heights of 5.2m are offered on the main and upper decks and 4.6m on the tanktop. Vehicle access is over stern and bow door/ramps supplied by MacGregor with internal transfer between decks by means of tiltable ramps.

The single-section main stern ramp/door has a short length of 6.0m (plus 1.5m flaps) and offers a 19.8m-wide driveway into the main vehicle deck. A side-hinged ramp cover accesses the lower hold. This two-section cover is 42m-long and provides a clear opening width of 4.5m to the tanktop. The cover is watertight in the closed position.

A hoistable ramp (48m-long plus 5m flaps with a 6.1m driveway) links the main deck and the partly-open upper deck, closing weathertight in the upper deck when not transferring vehicles. Dangerous goods are carried aft of the gas-tight garage door on the weatherdeck.

FREE-FALL LIFEBOAT



Photos: C. Spigarski

Free-fall lifeboat and launching ramp with integral recovery system onboard car carrier



Photo courtesy of MacGREGOR

Wrong location of lifeboat far-away from accommodation



Photos: J. Babicz

*Free-fall lifeboat and simple launching ramp.
Recovery by a combined life-saving/provisions crane*

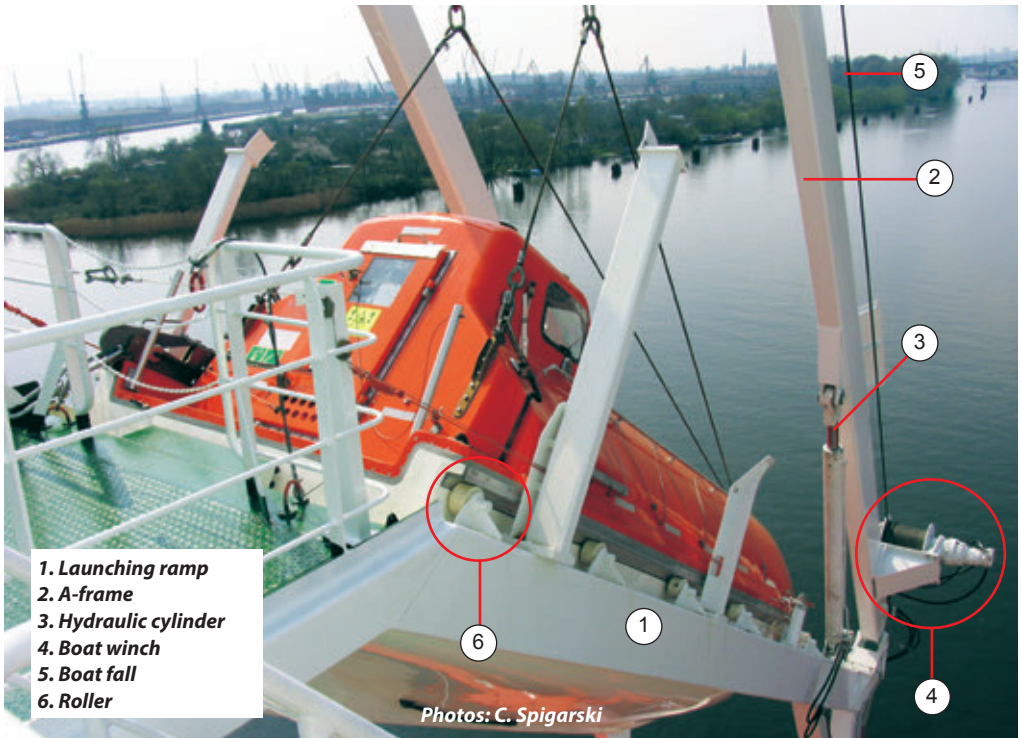

Launching ramp with the integral recovery system



Freon

Forward access into the main vehicle deck is arranged over a three-section bow ramp with an overall length of 17.0m (including 2m flaps) and a driveway of 6.0m. Above, a top-hinged door in the superstructure front allows access at this level to a shoreside linkspan.

The machinery space is located in a “three-quarter aft” position and is fitted out with a power system based on two main engines. With each unit developing a maximum 12MW, the service speed at 85% of this output is 23 knots. Each engine drives a 4.80m Wärtsilä CP propeller turning at 150rpm, through a Flender Navilus reduction gearbox.

Two Leroy Somer 1400kW/1500 rpm alternators, driven from the main engine gearboxes are fitted, along with a pair of Wärtsilä 8L20C/Leroy Somer 1723kVA diesel alternator sets. Two Aalborg 2350kg/h boilers satisfy steam demands, and two Wärtsilä 1200kW bow thrusters are installed. A Frank Monh pump system controls heel and two Blohm + Voss Industries fin stabilisers control roll.

Length, oa: 168.00m, Length, bp: 155.00m, Breadth, mld: 26.80m, Depth to main deck: 9.30m, Draught design/maximum: 6.30/6.50m, Deadweight design: 6200dwt, Gross tonnage: 22,532, Propulsion power: 2x12MW, Service speed at 85% MCR: 23.00 knots.

Freon – A halogenated hydrocarbon usually given a number which is related to its chemical formula. It is used as a refrigerant.

Frequency – The number of complete cycles of a periodic process occurring per unit time. The frequency is expressed in Hertz (Hz), which corresponds to one cycle per second.

Natural frequency – The frequency at which free oscillation occurs.

Freshwater generator, freshwater distiller – A unit used for conversion of seawater into fresh water by vacuum distillation based on evaporation and condensation. Single-stage freshwater generator consists of a chamber with two titanium plate packs acting as an evaporator and a condenser respectively. A vacuum of 85-95% is maintained in the system by a brine/air ejector. Seawater evaporates at a temperature of approximately



Wärtsilä Serck Como freshwater generator

- *The seawater pump is enabled through a control panel.*
- *After passing the condenser section the seawater will flow through the air-brine ejector.*
- *A small part of the seawater flow is used as feed water to the evaporation section, where it is then divided into each second channels.*
- *Through a suction process the air-brine ejector removes the air from inside the casing and the excessive feed water.*
- *After maximum of 5 minutes a vacuum of approx 90% is reached.*
- *Open the valves on the hot water inlet and outlet piping line.*
- *The evaporation of the feed water will start immediately.*
- *The vapour will flow through the demister and will be condensed in the condenser section.*
- *Please start the freshwater pump after a maximum of 2 minutes after opening for the hot water line.*

40°C due to the vacuum condition as it passes between the plates of evaporator heated by hot fresh water from the engine jacket cooling system, or by steam.

Generators can be equipped with disinfection units (Chlorination, UV-radiation and Silver ionization), pH-adjustment and rehardening filters.

Fretting contact – The contact between two surfaces under pressure and subject to a slight relative motion.

Fretting failure – Keyed-taper connections, splines, bolted connections and clamped flanges give rise to fretting failure. The basis is two surfaces which are able to move relatively to each other, even by a small amount, leading to contact scars. These areas can be subjected to very high stresses which can give rise to micro cracking, and it can grow if left uncorrected.

One example was a failed shaft connected to a flange by a key and taper. After the failure the drive side of the keyway was found to have had a number of small cracks occurring at the larger end. An identical piece of equipment showed identical signs of cracking which would have to fail in due course.

Froude number (F_n) – A non-dimensional number indicating the relation between a vessel's length and its speed, expressed as $F_n = V / \sqrt{gL}$; where V = speed, g = acceleration due to gravity, L = length of the vessel,

Fuel cell power pack – A fuel cell power pack consists of a fuel and gas processing system (the balance of plant), and a stack of fuel cells that convert the chemical energy of the fuel to electric power through electrochemical reactions. The process can be described similar to that of a battery, with electrochemical reactions occurring at the interface between the anode or cathode and the electrolyte membrane but with continuous fuel and air supplies.

The main drivers for developing maritime fuel cell technology are reduction in fuel consumption and lower impact (both local and global) on environment of ships' emissions to air. Additional benefits include insignificant noise and vibration levels, as well as lower maintenance requirements compared to traditional combustion engines. Key challenges include the demand for clean, low carbon fuel and the need to decrease investment costs, improve service lifetime, and reduce the current size and weight of fuel cell installations.

Different fuel cell types are available and can be characterized by the materials used in the membrane. Molten Carbonate Fuel Cell (MCFC) and Solid Oxide Fuel Cell (SOFC) technologies are high-temperature fuel cells that are flexible as regard to choice of fuel: methanol, ethanol, natural gas, biogas, and hydrogen are most commonly used. MCFC is the more mature of these two technologies, while SOFC is considered to have the greatest potential in terms of efficiency and power density.

An electric stack efficiency of 50-55% has been obtained from both MCFC and SOFC installations, and when internal consumption is included this is lowered to 45-50%. High operating temperatures lead to high exhaust temperatures (400-800°C) that, together with a large volume flux of exhaust, yield a significant potential for heat recovery. The fuel to electric efficiency can be increased to 55-60% for MCFC plants and to above 60% for SOFC plants when heat recovery is included.

Fuel cell power pack

A complex balance of plant to handle fuel and air treatment is required for both technologies, as a result larger units are preferred. MCFC units generally have one fuel cell stack of about 200–500kW, while an SOFC unit is built from several smaller stacks of 1–20kW each.

The SOFC units can be built to be significantly more compact than MCFC units, but the complete power packs remain large in volume compared with diesel generators. High-temperature fuel cells must operate at stable temperatures, and therefore have low tolerance to rapid load changes. In general, these fuel cell types can only be justified in applications where power and heat demands are high and stable.



Photo courtesy of Wärtsilä Corporation

VIKING LADY has been designed by Wärtsilä and is equipped with a complete Wärtsilä propulsion and power electronics system

A methanol-fuelled marine SOFC plant of 20kW was tested on board the car carrier Undine in 2010. The largest marine fuel cell installation to date is the 330kW MCFC, installed on board the platform supply vessel VIKING LADY designed by Wärtsilä Ship Design. The LNG-powered ship was delivered for operation on the North Sea in April 2009, and, in September of the same year, the 330kW MCFC power pack developed by MTU in Germany was installed. The fuel cell was connected to the main switchboard for the first time in December 2009. After initial testing, VIKING LADY became the first vessel to obtain the class notation FC-Safety, as described in the DNV Rules (DNV, 2008).

The fuel cell stack, together with the required balance of plant, is located in a large, purpose-built container (13 x 5 x 4.4m). Project-specific electrical components (transformers, converters and DC bus) designed to protect the fuel cell from potentially harmful disturbances on the power grid, are situated in a standard 20-ft container. The total weight of the containers is 110t, but both weight and volume could be significantly reduced in future fully integrated systems.

During its first year in operation, the fuel cell stack showed no signs of degradation, indicating that the measures taken to protect the fuel cells were appropriate. The stack was protected against electric disturbances. In addition, ship movements, hull vibrations, and air salinity were also taken into consideration when designing the fuel cell stack and its container and support systems. In January 2012, the fuel cell was cooled down and conserved for future demonstration projects. A total of 18,500 operating hours were logged without signs of severe performance degradation. Approximately half of the time logged was in idling mode.

Fully loaded, the fuel cells produced electricity at a measured electric efficiency of 52.1 % based on the lower heating value of the LNG. Although exact measurements of gas to grid efficiency were not possible for the current system setup, this was estimated to be 48.5% including internal consumption, and 44.5% when DC/AC conversion was also accounted for. A heat exchanger that produced warm water from the fuel cell exhaust was tested, with about 80kW heat recovered. This increased the overall fuel efficiency to slightly above 55%. With optimal system integration, there is the potential for increasing the electrical efficiency to close to 50%, and the fuel efficiency up to 60%.

Although the cost, weight, and volume of the test installation were high, the feasibility of installing and operating a fuel cell power pack in a marine environment was successfully demonstrated. In future marine MCFC designs more focus should be directed towards thermal integration, utilizing the high quality exhaust heat, and on including some form of energy storage to allow for stable load conditions for the fuel cell.

Further reading: DNV paper "*Fuel cells for ships*"

Fuel Conditioning Module (FCM) – A new automated two-stage **fuel oil supply module** developed by Alfa Laval.

Fuel oil – Any oil used as a fuel in connection with the propulsion and auxiliary machinery of the ship.

Fuel oil service tank – An oil fuel tank that contains only the required quality of fuel ready for immediate use. Two oil fuel service tanks, for each type of fuel used on board, necessary for propulsion and generator systems, are to be provided. Each tank is to have a capacity for at least eight hours operation, at sea, at maximum continuous rating of the propulsion plant and/or generating plant associated with that tank. The arrangement for oil fuel service tank is to be such that one tank can continue to supply oil fuel when the other is being cleaned or opened for repair (according to Lloyd's Register).

Where main engine, auxiliary engines and boilers are operated on heavy fuel oil, the following equivalent arrangement may be accepted:

- One HFO Service Tank with a capacity of at least 8h at maximum continuous rating (MCR) of the propulsion plant and normal operating load at sea of the generator plant and the auxiliary boiler.
- One MDO Service Tank with a capacity at least 8h at MCR of the propulsion plant.

Where main engine and auxiliary boilers are operated on HFO and auxiliary engines are operated on MDO, the following equivalent arrangement may be accepted:

- One HFO Service Tank with a capacity at least 8h at MCR of the propulsion plant and normal operating load at sea of the auxiliary boiler.
- Two MDO Service Tanks, each with a capacity of at least the higher of:
 - 8h at normal load at sea of the auxiliary engines,
 - 4h at MCR of the propulsion plant and normal operating load at sea of the generator plant and the auxiliary boiler.

Fuel oil service system – see **fuel oil systems**.

Fuel oil stability – Fuel oils are produced from various crude oils and refinery processes. Due to incompatibility, such fuels can occasionally tend to be unstable when mixed. This is why the mixing on board should be avoided to the widest possible extent.

Fuel oil system – Various piping systems, provided for bunkering, storage, transfer, offloading and treatment of fuel oils. The following systems are provided for diesel engines that operate on heavy fuel oils: **Fuel oil transfer system**, **Fuel oil treatment system** and **Fuel oil supply system**.

Fuel oil transfer system – This system receives and stores fuel and delivers it to **settling tanks**. Fuel oils are loaded through deck fill connections that have sample connections provided to permit the fuel to be sampled as it is taken aboard. HFO is loaded in storage tanks fitted with heating coils. In preparation for use, HFO is transferred to the fuel oil settling tanks via FO transfer pumps which are equipped with a suction strainer. Piping is so arranged that the pumps can transfer fuel between storage tanks and then to the deck connections for offloading. Settling tanks are used to permit gross water and solids to settle on the bottom.

Fuel oil treatment system – From the **settling tanks** fuel oil is transferred to the service tanks via FO treatment system. For cleaning of heavy fuel oils (HFO) the two stage process is commonly used. The fuel is heated in a settling tank to about 50-60°C and then is drawn out by the purifier inlet pump. The inlet pump delivers the fuel to a thermostatically-controlled heater which raises the fuel temperature to about 80°C, and thence to the centrifugal **purifier**. The dry purified fuel is then transferred to a centrifugal **clarifier** by the purifier discharge pump. After clarification the clarifier discharge pump delivers the fuel to the service tank for the engine use.



Fuel oil supply module

Fuel oil supply system – This system supplies the fuel from the service tank to the diesel engine. The system consists of: a supply flow meter, supply pumps, circulating pumps, preheaters, the final filter, a viscosity controller, a FO venting box.

The pressurised system is preferable while operating the diesel engine on high viscosity fuels. It can be delivered as a modular unit (fuel oil supply module), tested and ready for service supply connections.

Fuel oil tank protection – Old vessels, but unfortunately also many new ones, have bunkers in double hull and any shell damage can result in oil spill. This common practice has been stopped by new revised **MARPOL Annex I**, Regulation 13A. This regulation applies to all ships with an aggregate oil fuel capacity of 600m³ and above for which the building contract is placed on or after 1 August 2007, or the delivery of which is on or after 1 August 2010.

According to the new regulation, individual oil fuel tanks shall not have a capacity of over 2500m³. The provisions of this regulation will apply to all oil fuel tanks except small tanks with an individual capacity not greater than 30m³, provided that the aggregate capacity of such excluded tanks is not greater than 600m³.

For ships having an aggregate oil fuel capacity of 600m³ and above, oil fuel tanks shall be located above the moulded line of the bottom shell plating nowhere less than the distance h as specified: $h = B/20m$ or $h = 2.0m$, whichever is the lesser. The minimum value of $h = 0.76m$.

For ships having an aggregate oil fuel capacity of 600m³ or more but less than 5000 m³, oil fuel tanks shall be located inboard of the moulded line of the side shell plating, nowhere less than the distance w which is measured at any cross-section at right angles to the side shell as specified: $w = 0.4 + 2.4C/20,000m$, "C" is the vessel's total volume of oil fuel, in m³, at 98% tank filling.

The minimum value of $w = 1.0m$, however for individual tanks with an oil fuel capacity of less than 500m³ the minimum value is 0.76m.

For ships having an aggregate oil fuel capacity of 5000m³ and over, oil fuel tanks shall be located inboard of the moulded line of the side shell plating, nowhere less than the distance w which is measured at any cross-section at right angles to the side shell as specified below:

$w = 0.5 + C/20,000m$, or $w = 2.0m$, whichever is the lesser. The minimum value of $w = 1.0m$.

Fuel oil treatment – Fuels supplied to a ship must be treated on board before use in order to remove solid as well as liquid contaminants. The solid contaminants in the fuel are mainly rust, sand, dust and refinery catalysts. Liquid contaminants are mainly fresh or salt water. The **settling tank** is the first step in fuel treatment process. Water and sediments can be separated by gravity and drained off at the bottom of the tank. Effective cleaning of residual fuels can only be ensured by centrifuges: a clarifier to separate particles and/or a purifier to separate water. In order to remove any solid particles not separated by centrifuging, fine filters are placed directly after the centrifuge, or in the supply line to the engine.

Fuel oil unit – The equipment used for preparation of oil fuel for delivery to an oil-fired boiler, or equipment used for preparation for delivery of heated oil to an internal combustion engine, as well as any oil pressure pumps, filters and heaters dealing with oil at a pressure of more than 0.18 N/mm² (1.8 bar).

FUEL OIL TREATMENT PLANT WITH CENTRIFUGAL SEPARATOR



1. Control and monitoring unit
2. Separator

3. Sludge transfer unit
4. Heater unit

5. Feed pump unit



Photos: J. Babicz

Fuel viscosity – A measure of resistance of the fuel to flow at a stated temperature. According to ISO, the kinematic viscosity of heavy fuels should be specified in centistokes ($cSt = 10^{-6} m^2/s$) at 100°C.

Fuel-water emulsification (FEW) – Invisible smoke technology is based on fuel-water emulsification (FEW), whereby the heavy fuel or diesel oil is homogenised with fresh water before injection into the engine. Apart from lowering smoke and soot emissions significantly, the system is claimed to reduce NOx levels to.

Full speed – Highest possible speed of a vessel.

Fumes – Harmful gas produced by fires, chemicals, fuel, etc.

Funnel – A smokestack of a vessel.



Photo: J. Babicz

Unconventional funnel connected with signal and radar masts

Furnace – Interior of **boiler** where fuel is burnt.

Fuse – A device that protects an electrical circuit from overcurrent.

Fusion – The melting of filler metal and base metal (substrate) together, or of base metal only, to produce a weld.

Galley – A kitchen on a ship. The galley and the **messroom** are usually on the same deck. It is ideal to have provision stores at the same level. If this is not possible, direct stairs should connect the galley and provision stores.

Galley arrangement should be carefully thought through, as to minimise any movement during food preparation, cooking and serving as well as washing-up. The range should be arranged with its length athwartships, as to minimise the danger of an accident – a person being thrown onto hot plate by ship rolling motion. A cook should have a separate WC arranged.



Picture courtesy of Peene-Werft and Fotostudio Wasmund, Wilhelmstrasse 54, 17438 Wolgast

Galley on the oil spill response vessel ARKONA

Galvanizing – Coating metal parts with zinc for protection against rusting.

Gangway –

1. A narrow portable platform used as a passage by persons entering or leaving a vessel moored alongside a pier or quay.
2. A raised walkway between **superstructures** such as the **forecastle** and the **bridge** or between the bridge and the **poop**.

Garbage – Garbage means all kinds of victual, domestic and operational wastes generated during the normal operation of a ship and liable to be disposed of on regular basis or periodically. It does not include fresh fish and parts thereof or sewage. It also excludes substances and emissions prohibited or controlled under other Annexes to **MARPOL**.

Under the revised MARPOL Annex V, discharge of any garbage is now prohibited, except for those under special permissions. The document changes the past presumption that garbage can be ejected directly into the sea, taking into account the type of waste and the vessel's distance from shore. Nowadays, port reception facilities are to be considered

the primary means of discharge, the only exception being food wastes, certain cargo residues, animal carcasses and certain cleaning agents deemed as non-harmful to the marine environment.

Cargo residues are remnants of any cargo material on board in cargo holds or tanks which remain after unloading procedures and cleaning operations are completed and includes excesses and spillage from loading or unloading.

Cargo-associated waste means all materials which became waste as a result of use on board a ship for cargo stowage and handling, and includes dunnage, shoring, pallets, lining and packing materials, plywood, paper, cardboard, wire and steel strapping.

Operational waste means all maintenance waste, cargo associated waste and cargo residues except residues or waste from oil or oily mixture, noxious liquid substances, non-polluting liquid substances or harmful substances in packaged form.

Plastics include synthetic ropes, synthetic fishing nets, plastic garbage bags, foam plastics and incinerator ashes from plastic products which may contain toxic or heavy metal residues.

Garbage collection craft BATELLO ECOLOGICO

According to **Significant Small Ships** of 2004

The Italian Ministry of Environment ordered 30 fast boats for removing rubbish and floating debris from protected coastal areas. The first craft was delivered in 2003. A short response time was requested leading to a minimum speed requirement of 20 knots. Therefore, the hull is Gull-shaped, as a balanced compromise between the large deck area of a catamaran and the seaworthiness of a monohull.

The craft is equipped with twin Volvo Penta stern drives, each delivering an 110kW output. It achieved a top speed of over 25 knots during sea trials.

Refuse are hauled in through different ways: using hand equipment; using a small folding crane (for loads up to 280kg); or using an electro-hydraulic stainless steel basket positioned forward. Once deployed, the basket remains about 0.20m below water line in order to collect all the floating debris which is collected into a removable 20m³ rubbish tank.

Garbage Management Plan – All ships of tonnage 100 gross or above as well as every ship which is certified to carry 15 persons or more, must have a Garbage Management Plan. This document should identify procedures for the collection, storage, processing and disposal of **garbage** on board the ship, including procedures for the use of equipment, and should identify the person responsible for carrying the plan out. It should be written in the crew's working language. The crew should be trained in garbage management procedure and should be acquainted with the content of the plan. It is the master's of the ship responsibility to ensure that the plan is effectively followed and implemented.

Further reading: ABS Publication "Garbage Management Manual" (2005), can be downloaded from www.eagle.org

Garbage processing equipment – Incinerators, compactors, comminuters or other devices for shipboard garbage processing.

Garbage Record Book – Ships with a **Garbage Management Plan** are also required to have a Garbage Record Book on board in a place where it can be easily inspected. The record

book must be filled in by the officer in charge after every discharge of garbage into the sea, every delivery of garbage to port waste reception facilities and every incineration operation. Each entry should highlight the position of the ship, the date and time of the operation, an estimate of the amount and a description of the type of garbage. The Master of the ship signs each page after it is completed. The record should be kept for two years once the book is completed.



Gas carrier, gas tanker – Gas carriers are tankers intended to carry different liquefied gases used for energy purposes (petroleum gases, natural gases), in the chemical industry (ethylene, vinyl chloride, propylene, etc.) or used as a raw material for making agricultural fertiliser (ammonia). A most notable characteristic of liquefied gas carriers is being equipped with special cargo handling installations designed to keep gas products in a liquefied state. The design and operation of liquefied gas carriers is principally governed by the **International Gas Carrier Code** (IGC Code).

See also **Gas carrier standards, Gas carrier types, LNG tanker, and LPG tanker.**

Gas carrier cargo handling – Typical operation cycle of most refrigerated type liquefied gas carriers includes drying, inerting, cooling down, preparation work prior to loading, loading, laden voyage, unloading, ballast voyage, stripping, warming up and gas freeing.

Drying – In order to prevent ice formation during cooling and to maintain the quality of products, moisture in all cargo tanks and associated piping is to be eliminated. Drying is achieved by introducing dry air into areas to be dried.

Inerting – Inerting is done by supplying an inert gas to cargo tanks and associated piping in order to produce non-explosive atmosphere in these areas. Two types of inert gas are commonly used: gas produced with an **inert gas generator** and nitrogen gas.

Cooling down – In order to avoid any damage to cargo tanks and piping due to thermal shock as well as to reduce the generation of **boil-off gases** (BOG) during loading operations, cargo tanks and piping are gradually cooled down. This procedure often consists of introducing low temperature cargo vapour into the cargo tanks and piping or of spraying the tanks with liquefied cargo.

Loading – Cargoes are loaded into cargo tanks through cargo liquid lines by means of shore side pumps. Cargo vapour present in tanks is returned to the shore terminal via cargo vapour lines using compressors on board. Since the vapour is not vented at any time during this operation, this process is often referred to as a closed cycle one.

Laden voyage – Except for pressure type gas carriers, cargo temperature and pressure control is mainly carried out at sea. Boil-off gases produced at sea are sent to re-liquefaction plant and returned to the cargo tanks after being re-liquefied. In the case of LNG carriers, BOG may either be reliquefied or sent to the main engines as fuel for propulsion.

Unloading – Cargoes are discharged using cargo pumps on board and cargo gases are supplied from the shore side terminal. This operation is carried out in a closed cycle. A sufficient portion of the cargo is retained in one of the cargo tanks in order to carry out cooling down operation during ballast voyage.

Stripping – All cargo in the tanks is completely discharged as much as possible before any warming up and gas-freeing operations are undertaken.

Warming up – It consists of raising the temperature of the cargo tanks and their piping in order to carry out gas-freeing operation. During warming up all remaining cargo is vaporized and heated by a cargo vaporizer and heater installed onboard. The heated gas then circulates through tanks and piping to raise the temperature of the entire system.

Gas carrier standards – The design standards defined by the **International Gas Carrier Code** (IGC Code). Depending upon the degree of hazard presented by the products to be carried, gas carriers should be designed according to one of the following standards: – type 1G ship, – type 2G ship or type 2GP ship, – type 3G ship. Thus, a type 1G ship is a gas carrier intended for the transportation of products of the greatest overall hazard and types 2G/2GP and type 3G for products of relatively lower hazards. Accordingly, a type 1G ship should survive the most severe damage and its cargo tanks should be located at the maximum prescribed distance inboard from the shell plating.

Gas carrier types – Gases can be liquefied by using one of the following methods:

1. Pressurization under normal temperature.
2. Refrigeration and pressurization.
3. Refrigeration under atmospheric temperature.

Ships that carry gas products under state 1 above are referred to as “fully pressurized gas carriers”, while those that carry gas product under state 2 are known as “semi-refrigerated gas carriers”. Those under state 3 above are called “refrigerated gas carriers” and this type is often used in design of large **LPG** and **LNG carriers**.

Ad 1. Pressure gas carriers, also fully-pressurized ships – These ships are the simplest of all gas carriers in terms of containment systems and cargo-handling equipment and carry their cargoes at ambient temperature. Independent pressure vessels with a typical design vapour pressure of 17.5 bar are used as cargo tanks (type C tanks). Ships with higher design vapour pressure are in service; 18 bar is quite common – a few ships can accept pressure up to 20 bar. No thermal insulation or a reliquefaction plant is necessary and cargo can be discharged by either pumps or compressors.

Because of their design pressure the tanks are extremely heavy. As a result, fully pressurised ships tend to be small with maximum cargo capacities of about 4000 m³ and they are used to carry primarily LPG and ammonia. See also **CNG concept**.

Ad 2. Semi-refrigerated gas carriers – Constructed in the size range of 1500 to 30,000 m³, this type of gas carrier evolved as the optimum means of transporting the variety of gases, from LPG and VCM to propylene and butadiene. Today, this type of ship is the most popular amongst operators of “smaller-size” gas carriers.

Semi-refrigerated gas tankers use pressure vessel tanks designed for design vapour pressure in the range of 4-8 bar. The tanks are made either from low temperature steels for carriage temperature of –48°C which is suitable for most LPG and chemical gas cargoes, or from special alloyed steels to allow the carriage of ethylene at –104°C. See also **Semi-refrigerated gas carrier NORGAS ORINDA**.

Ad 3. Fully-refrigerated gas carriers – They can carry cargoes at approximately atmospheric pressure and are generally designed to transport large quantities of LPG and ammonia. Different cargo containment systems have been used in FR ships. The most widely used arrangement is the independent tanks with single side shell. Type A prismatic freestanding tanks capable of withstanding a maximum design vapour pressure of 0.7 bar are used. A complete secondary barrier is required and the hold spaces must be inerted when carrying flammable cargoes.

Gas cylinder – Bottle of the capacity up to 150 liters, charged with gases in special filling stations.

Gas-dangerous space, gas dangerous zone – A space not arranged or equipped in an approved manner to ensure that its atmosphere is at all times kept in gas-safe condition. **IMO** Codes defines many gas-dangerous spaces on board gas carriers, chemical carriers etc.

Gas engine – A gas engine is an **internal combustion engine** which uses blast furnace gas, producer gas, natural gas and others as fuel. The first practical gas engine was built in 1860 by a Frenchman named Lenoir, but as it was largely improved by Dr. Otto, his name was given to its cycle of operations. He made his first gas engine in 1876. The Otto cycle utilizes an ignition source such as a spark or small amount of pilot fuel to start the gas fuel burn.

Gas free – A tank, compartment or container is gas free when sufficient fresh air has been introduced into it to lower the level of any flammable, **toxic**, or **inert gas** to the level required for a specific purpose, e.g. **hot work**, entry, etc. Tanks and voids are routinely checked to assure that they remain below an explosive level when work is being performed on a vessel.

Gas freeing – The procedure of removing dangerous and explosive gases from the interior of tanks (usually vapours originating in the cargo of oil tankers and chemical carriers). Gas freeing consists of a series of operations in which cargo vapour is replaced with **inert gas** which, in turn is purged with air to prevent explosion hazard.

Gas indicators – Portable instruments for measuring the concentration of **hydrocarbon gas** in inerted and non-inerted atmospheres, of other toxic gases and oxygen.

Gas processing – Separation of oil and gas involving removal of impurities and gas condensate from natural gas.

Gas tanker CLIPPER VIKING

According to **The Motor Ship** October 1998

CLIPPER VIKING is an ice-strengthened gas tanker type 2G, designed to carry ethylene, vinyl chloride monomer (VCM), ammonia, propylene oxide, propane, butane and other liquefied gases. The ship is equipped with three bi-lobe cargo tanks (independent tanks type C) with total capacity of 12,500m³.

The cargo handling plant comprises four Sulzer 2K 140-2H cargo compressors, two Sabroe SAB 202s refrigeration compressors, a pair of surge drums, two LPG economisers, a pair of ethylene condensers/refrigerant receivers, and two seawater-cooled refrigerant condensers. The ship twin cargo heaters comprise a seawater-heated device (15°C) capable of heating 100 t/h of propane from –42°C to 0°C, and a thermal oil-heated device capable of heating 60 t/h of propane from –42°C to 0°C.

The cargo handling plant is completed by six **deepwell pumps**, each of 200 m³/h, two booster pumps, each of 300 m³/h, and associated control and monitoring equipment, fire extinguish/safety equipment, and gas detection plant. Assuming that the tanks are filled to 98.5% and at maximum ambient temperature, the cargo handling plant is capable of cooling ethylene from –99°C to –103°C in 70 hours, and of cooling propylene from –3°C to –47°C in 300 hours. It also provides a loading rate (without vapour return) of 1,200 m³/h for ethylene (at –103.8°C), and 170 m³/h, 260 m³/h and 575 m³/h, for propylene at +20°C, +10°C, and 0°C, respectively.

Length, oa: 145.70m, Length, bp: 135.40m, Breadth, mld: 20.50m, Depth to main deck: 13.80m, Design draught: 9.70m, Deadweight at 9.70m: 13,500dwt, Trial speed: 17 knots, Total cargo tank volume: 12,500m³, Main engine output: 7 980kW at 148 rev/min.

Gas Reformer – Wärtsilä GasReformer is the solution for utilising gaseous fuels that either contain large amounts of heavier **hydrocarbons** or vary in their composition. Gases that were previously considered as waste can now be converted into a valuable resource of energy. Together with the Wärtsilä dual-fuel (DF) engines, this is the most efficient and flexible solution for utilising associated gas or volatile organic compounds (VOCs) recovered from oil production.

Gas treatment – Removal of impurities from natural gas such as water, sulfur compounds and carbon dioxide.

Gas turbine – An internal combustion engine of reaction type consisting of an intake duct, a compressor, a combustion chamber, a turbine and an exhaust duct. The gas turbine is used in propulsion systems, as drivers for large compressors and for electric power production.

Gasket – Flexible material used to pack joints in machinery, piping, doors, hatches, etc, to prevent any leakage.

Gasoline, petrol – A distillate of petroleum which is used in spark ignition internal combustion engines. Ignition qualities are measured with an octane number.

Gate valve – A valve which permits for uninterrupted flow when open; see **Stop valves**.

Gauge

Gauge – An instrument or device for measuring, indicating or comparing a physical characteristic.

Diaphragm gauge – A gauge in which the sensing element is relatively thin and its inner portion is free to deflect with respect to its periphery.

Pressure gauge – A gauge that indicates the pressure in the system.

Gauge glass – A glass tube or arrangement of glass plates fitted to a gauge used to give a visual indication of the level of liquid in a tank, pressure vessel, or boiler.

Gauging –

1. Tank gauging, level gauging – the process of measuring tank contents.

Every modern chemical tanker must have an accurate and reliable tank gauging system. The system must be capable of measuring the tank contents at any level of filling and must be independent of the high level and overflow control system alarms. The Code specifies three different types of gauging systems dependent upon the flammability and toxicity of the cargo, viz: open gauging, restricted gauging and closed gauging.

2. Thickness measurements which are carried out to evaluate the corrosion wastage of hull structure. Ultrasonic thickness (UT) measurement is applied in the maritime industry. The gauging of a plate or member normally starts out with two readings. If one appears to indicate a suspect condition, then more shots are taken.

Gauging devices (for measuring the tank contents)

Closed gauging device – A device which is separated from the tank atmosphere and keeps tank contents from being released. It may penetrate the tank; the examples are float-type systems, electronic probe, magnetic probe and protected sight glass. Or it does not penetrate the tank: the examples are systems using radioisotopes, ultrasonic or radar devices. Closed gauging is required for cargoes with a severe flammable or health hazard.

Indirect gauging device – A device which determines the level of a liquid by means of weighing or pipe flow meter, for instance.

Open gauging device – A device which makes use of an opening in the tanks and may expose the gauger to the liquid or its vapour. Examples are tank ullage openings.

Restricted gauging device – A device that penetrates the tank and which, when in use, permits a small quantity of vapour or liquid to be exposed to the atmosphere. When not in use the device is completely closed.

Gauging systems

Electro-pneumatic system – This system involves blowing air down the pipe to the liquid in the tank and measuring the pressure needed to force the liquid out of the pipe.

Hydrostatic pressure system – The gauge sensor indicates the level by measuring the pressure of the contents of the tank.

Radar tank gauging system – A radar transmitter is installed in each cargo tank at the upper deck level. The length of time taken for the radar wave to return to the radar transmitter from the surface of the cargo is fed into a computer located within the superstructure, which determines the contents of the tank.

TankRadar system – Radar-based monitoring system developed by Saab Marine Electronics. A radar gauge is installed outside the tank, thus making maintenance and

repair a much simpler task. The electronic box and temperature and vapour pressure sensors can easily be removed, tested or replaced by simply closing the ball valve. In 1998 the first Saab radar gauge was tested onboard an LNG carrier with success. TankRadar sends microwaves through a smooth strength cone from an electronic box where the microwaves are generated into a still pipe that stretches from top to bottom of the LNG tank. The pipe, which is penetrated with ventilation holes to equalise the level in the pipe, enables the microwaves to measure the liquid level accurately.

Gear pump – A displacement pump comprised of two interconnecting gear wheels in a closely fitting casing. The liquid is trapped between the gear teeth and the casing as one gear wheel is driven and the other meshes with it. See also **rotary pump**.

Gearred – A vessel equipped to load and discharge by its own means (derricks or cranes).

Gearless – A vessel not equipped to load and discharge by its own means (without derricks or cranes).

General cargo ship – A ship with one or more decks, having ability to carry a variety of commodities in different forms such as boxed, palletized, refrigerated, and with the possibility to accommodate bulk materials such as grain.

General emergency alarm – A sound signal of seven short blasts and one prolonged blast given with the vessel sound system.

General radio communications – Operational and public correspondence traffic, other than distress, urgency and safety messages, conducted by radio (SOLAS).

Generator – A machine which converts mechanical power into electrical power. The 3-phase AC-type generators are used nowadays on board ships. An AC generator is the same machine as a synchronous motor. It uses rotor field windings powered by a direct current which induce an AC output voltage on the stator armature windings.

Geophysical – The use of geophysical techniques – electric, gravity, magnetic, seismic or thermal – in the search for economically valuable hydrocarbons, mineral deposits or water supplies or to gather information for engineering projects.

Geotechnical ships – These vessels operate on a site to detect the presence of any subsea hydrocarbon reservoirs. Geotechnical ships carry out corings, that is the picking up of seabed samples.

Girder – A collective term for primary supporting structural members.

Deck girder – A continuous stiffening member which runs fore and aft along a ship to support the deck.

Double bottom girder – A longitudinal, vertical plate extending from the bottom shell to the inner bottom, usually with large holes for access and weight saving.

Hull girder – The components of a hull structure that contribute to its strength when subjected to longitudinal and/or transverse bending e.g. the shell plating, decks, inner bottom, **longitudinals**, **bulkheads** and girders.

Gland – A device for preventing leakage at a machine joint, as where a shaft emerges from a vessel containing a pressurized fluid (e.g. stern tube).

Glare – Glare is the sensation produced by luminance within the visual field that is sufficiently greater than the luminance to which the eyes are adapted causing annoyance, discomfort or loss of visual performance and visibility. Glare is experienced if windows or light sources, seen directly or by reflection in shiny surfaces, are too bright compared to the general brightness within the interior of the **bridge**.

Glass crushing – Crushing for recycling is the sensible procedure for two reasons: incinerated or crushed glass cannot be discharged overboard; land-based facilities will not accept ash-contaminated glass for recycling.

Glass reinforced plastic (GRP) – A combination of thin fibres of glass in various forms which, when mixed with resin cures to produce a hard, strong and chemically inert material.

Global Positioning System (GPS) – A satellite-based navigation system operated and maintained by the US Department of Defense. GPS consists of a constellation of 24 satellites providing worldwide, 24-hour, three dimensional (3D) coverage. Although originally conceived for military needs, GPS has a broad array of civilian applications including survey, marine, land, aviation, and vehicular navigation. As a satellite system, GPS is immune from the limitations of land-based systems such as Loran. By computing the distance to GPS satellites orbiting the earth, a GPS receiver can calculate an accurate position. A 2D position calculation requires three satellite ranges. A 3D position calculation, which additionally provides altitude, requires four satellite ranges. GPS receivers can also provide precise time, speed, and course data, which is beneficial for marine navigation.

See also **Differential GPS**.

Global warming potential (GWP) – The ratio of the warming caused by a certain substance to the warming caused by a similar mass of carbon dioxide (the GWP of CO₂ is defined to be 1,0). All GWP values are calculated over a 100-year time horizon.

Globe valve – A valve with a spherically-shaped body enclosing the valve seat or disc. Liquid flow is arranged from the below to the above of the valve seat so that the upper chamber is not pressurized when the valve is closed.

GMDSS (Global Maritime Distress and Safety System) – An integrated communication system which uses satellite and terrestrial radio communication to ensure that no matter the ship's position in distress, assistance can be sent. GMDSS incorporates the Inmarsat and EPIRB satellite systems to improve the reliability and effectiveness of the distress and safety system on global basis. DSC-equipped marine radios are used for routine communications and for transmitting, acknowledging and relaying distress alerts. Other elements Of the GMDSS include:

- The coastal NAVTEX broadcast system,
- High seas SafetyNet broadcast system,
- The Search and Rescue Transponder (SART) for liferafts enhancing the radar visibility of small targets.

All passenger and cargo ships over 300 grt on international voyages have to carry satellite and radio communication equipment for sending and receiving distress alerts, maritime safety information and for general communication. The requirements were published in Chapter IV of **SOLAS** on Radio communications and were adopted in 1988. Entered into force on the 1st February 1992, they were fully implemented seven years later.

Gouging – The removal of metal from a welded seam in order to make a back-run for a butt weld. Gouging is frequently employed in preference to grinding for the removal of large quantities of weld metal prior to repairs or modifications to the weld preparation. The gouging process employs a carbon electrode to create an arc against the work piece and a jet of compressed air removes the subsequent pool of molten metal.

Governor, speed governor – During normal operation, the engine speed is controlled by a governor which regulates the injected fuel quantity corresponding to the load. The governor shall prevent the engine from exceeding the rated speed by more than 15%.

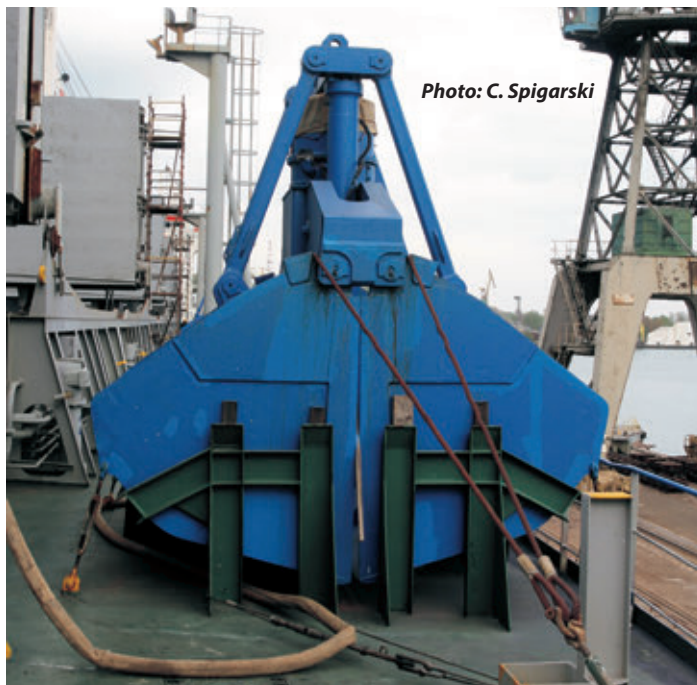

Photo: C. Spigarski

Grab – A bulk cargo-handling device consisting of a bucket which is hinged to open and close. It is open when lowered into the cargo and then closed and lifted out full. It is opened to discharge the cargo ashore, or into the ship cargo hold.

Grab handling – Certain types of bulk cargoes may be discharged by means of special grabs. Such grabs are either connected to ship derricks or to shore cranes. The inner bottom should be reinforced in order to withstand grab discharging.

Grain – Wheat, maize (corn), oats, rye, barley, rice, pulses, seeds and their processed forms. Grain stows at 1.2 – 2.0m³/t. It has a low angle of repose and shifts easily if not properly stowed. Grain can be easily damaged during shipment. It is particularly important that seawater does not leak through the hatches.

Grain capacity – The cubic capacity of a cargo hold measured to the shell plating.

Grain hatch – A small, manually-secured **hatch** fitted to the hatch cover, used during loading of grain cargoes.

Grating – Light perforated platform or walkway built up of metal bars, used for access to machinery.

Gravel – Small stones, used for making a surface for paths, roads, etc.

Gravity drain system – A piping system in which flow is accomplished solely by the difference between the height of the inlet end and the outlet end.

Gravity welder – A device consisting of a tripod, one leg of which acts as a rail for a sliding electrode holder. Once positioned and with the arc struck, the device welds automatically until the holder operates a trip at the bottom of the rail.

Grease – A thick oily substance used to reduce friction between two surfaces.

Grease separator

Grease separator – A separator designed to extract vegetable and animal oils from **galley** grey wastewater before the water is discharged overboard.

Great Lakes ports – Ports in the lakes of Canada and the USA popular for grain, iron ore and coal shipments. In Canada: Port Arthur and Fort William in Lake Superior; Hamilton, Kingston, Toronto and Prescott in Lake Ontario. In USA: Chicago, Milwaukee in Lake Michigan; Duluth and Superior in Lake Superior and Toledo in Lake Erie.

Great Lakes ship – Cargo ship developed to carry raw materials and manufactured goods on the Great Lakes. Most of them carry bulk cargoes of **grain**, iron ore or coal.

Greenhouse gases (GHGs) – Any gas that absorbs infrared radiation in the atmosphere. Greenhouse gases include, carbon dioxide, methane, nitrous oxide, ozone, chlorofluorocarbons, hydro chlorofluorocarbons, hydro fluorocarbons, perfluorocarbons, sulfur hexafluoride.

Green sea – A seawater, which travels over the weather deck of a ship without any waves breaking.

Grim vane wheel – see **POWER-SAVING DEVICES**.

Gripes – Wire ropes which secure a lifeboat against the cradle when it is up on the davits.

Grothues spoilers – Fins fitted ahead of the propeller on both sides of the sternpost to improve the **propeller efficiency**.

Grounded – Connected to earth, or an extended conducting body, e.g. the hull of a ship, which acts as an earth.

Grounding – The term used when a vessel runs aground in an area where groundings are so common that the insurer of the ship considers it should not be deemed **stranding**. In most hull insurance policies, there appears the “Customary Grounding Clause” whereby it is stipulated that grounding in the Suez Canal, Panama Canal and other specified places shall not be deemed a stranding so that **underwriters** do not pay the cost of sighting the bottom for damage. Also deliberate contact by a ship with the bottom while she is moored or anchored as a result of the water level dropping.

Gudgeon – Bosses or lugs on sternpost drilled for the pins (pintles) on which the rudder hinges.

Gunwale – The junction of deck and shell at top of **sheer strake**.

Gusset – A triangular plate, usually fitted to distribute forces at a strength connection between two structural members.

Gymnasium – A special hall or room that has equipment for doing physical exercises.

Gyroscope – A wheel that spins inside a frame and is used for keeping ships and aircrafts steady.

Habitability – The acceptability of the conditions of a vessel in terms of **vibration, noise**, indoor climate and lighting as well as physical and spatial characteristics, according to prevailing research and standards for human efficiency and comfort.

Further reading: ABS Guide for “Crew Habitability on Ships” (2001), can be downloaded from www.eagle.org

Habitat – An underwater structure installed on the ocean floor which is permanently or periodically manned. It is generally maintained at ambient pressure or at pressure of one atmosphere. See also **HERO**.

Halon – A halogenated hydrocarbon used in fire fighting which inhibits flame propagation. The use of halogenated hydrocarbons as fire-extinguishing media on new ships is prohibited.

HAM (Humid Air Motor) **method** – Humidification of combustion air used to reduce **NOx emissions**. In the HAM unit, relatively hot and dry air from the turbocharger is mixed with the water vapour from the **heat exchanger**. The HAM unit replaces the intercooler and increases the humidity of the combustion air.

Hampered vessel – A vessel restricted by its ability to manoeuvre by the nature of its work or its deep draft.

Handbook – A short book containing information or instructions.

Handing over – Delivery of the ship to its owner.

Handle, also handgrab – Bent round bar of various sizes for use above access openings, on miscellaneous access opening covers or on hatch covers.

Handrail – A long bar fixed to the side of a passage or stairs for holding onto it.

Harbour, also haven – Any place which offers good anchorage and fairly safe station for ships, or where ships can be sheltered from wind and sea.

Harbour dues – Various local charges demanded from all seagoing vessels entering a harbour to cover maintenance of channel depths, buoys, lights, etc.

Harbour master – A person usually having the experience of a master mariner and having a good knowledge of the characteristics of the port and its whole area. He administers the entire shipping movements that take place in and within reach of the port he is responsible for.

Hard coating – A coating which changes chemically during its curing process; normally used for new constructions.

Hardener – In two-component materials, the component that produces chemical reaction linking the molecular chains of the **binder** into a more rigid structure.

Hardening – A type of steel heat treatment. The steel is heated to 850-950°C and then rapidly cooled by quenching in oil or water. The hardest possible condition for the particular steel is created and the tensile strength is thus increased.

Hardness –

1. The ability of a material to resist plastic deformation.

2. A measure of the ability of a sample of water to produce lather with a soap solution.

Hardness of the dry paint film – The ability of the dry paint film to resist mechanical impacts as scratching or penetration by hard object.

Harmonics – Generally, harmonics are oscillations in the base power **frequency**. In electrical AC systems, the base frequency is typically 50 or 60 hertz (Hz) and harmonics occur in

multiples of this, for example 100 Hz, 150 Hz, 200 Hz, etc. where the base frequency is 50 Hz. Harmonics occur whenever there is a disturbance of the voltage or current, e.g. if the current is interrupted or if AC current is synthesized in a converter. The problem with harmonics is that electrical devices may react differently when exposed to a different frequency than the one they are designed for, which may result in damage. This is an increasing problem in power systems as most power electronics solutions cause harmonics. The phenomenon can be reduced by the use of power filters or system design and component matching to minimize electrical harmonics.

Hatch, hatchway – A rectangular opening in a deck through which cargo and stores are loaded or unloaded.

Hatch coaming – Vertical plating bounding a hatch in order to stiffen its edges and resist entry of water to the space below.

Hatch cover – A large steel structure fitted over a hatch opening to prevent the ingress of water into the cargo hold. It may also be the supporting structure for deck cargo. Various designs exist for particular applications. The hatch cover has to be weatherproof and has to remain so when conditions change as a result of waves, temperature and cargo.

Folding hatch covers – Folding hatch covers for weather decks can be either of the low or high stowing type. The low stowing version and single pull hatch covers are designed in a number of panel configurations. The high stowing versions are also available in a number of configurations: for example, with two to six panels and with stowing taking place at one or both ends of a hatch.

Lift-and-roll Piggy-Back covers – One panel of each pair is operated by high-lifting hydraulic cylinders for vertical movement. The horizontal movement of the other panel is achieved by traction drive via electric motor, planetary gear and hydraulic brake after it has been raised by a wheel-lifting device.

Lift-away hatch covers – Usually multi-panel units designed so that there are several panels for each hatch opening. They can be opened in an independent order and they allow partial hatch opening. Hatches are opened with a spreader using the vessel cranes or container cranes on shore. After removal, the panels can be stowed on top of adjacent covers which are placed on the quay or on the ship deck. The weight of the cover, and any cargo stowed on it, is transferred to the ship structure by **bearing pads**.

Pontoon hatch covers – Pontoon type hatch covers feature a flat top and flat bottom plate and are weathertight.

Rolling hatch covers – Rolling covers are divided into two main types considering opening direction. Side-rolling covers open sideways and end-rolling covers lengthwise. Both types are well suited to act as weatherdeck covers for dry bulk carrier and, when designed to sustain internal liquid loads, also for OBO and Ore/Oil ships.

See also **Side-rolling covers of the ore carrier PEENE ORE**.

Hatch cover panel seals

Double rubber lip seal – In case of reduced weathertightness on cellular container vessels, some classes allow to use a joint between panels fitted with a double rubber lip seal preventing rain and spray from entering the hold.

Swing-seals – Hydraulically- or manually-operated seals for weathertight non-sequential operation. The swing-seal comprises a foldable steel beam fitted with gaskets. In the sea-



Photo: J. Babicz

Rolling hatch covers



Photo: J. Babicz

Double rubber lip seal

LIFT-AWAY HATCH COVERS

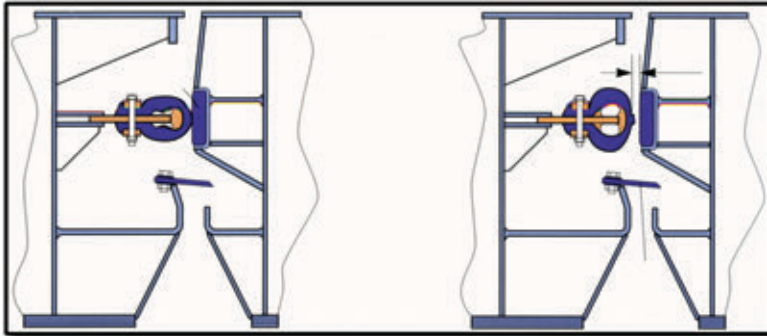

Omega seal secures weather-tightness without air pressure in the inside air hoses

Under pressure, Omega seal changes shape and the cross joint opens

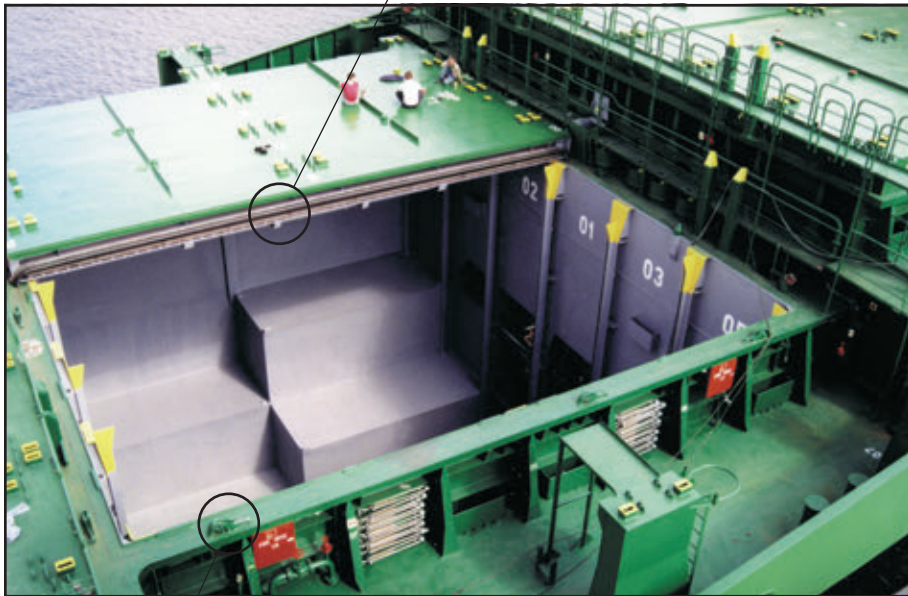

Cargo hold, container vessel 1200 TEU



Heavy cleat

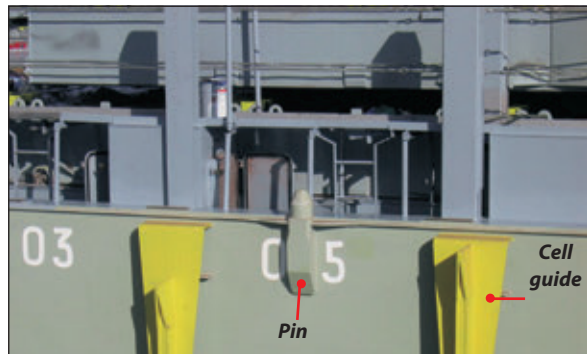

Cell guide

Pin

Panel guide and F-y stopper

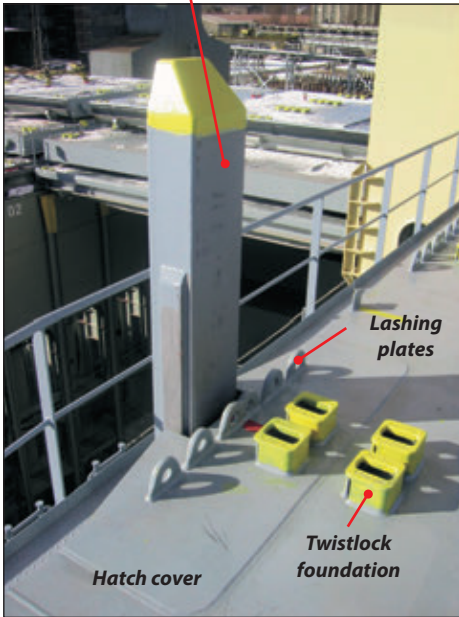

Battening fitting

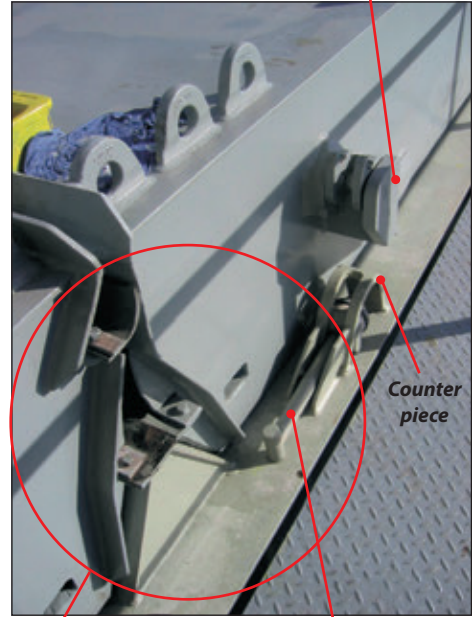

Double rubber lip sealing

Battening bolt

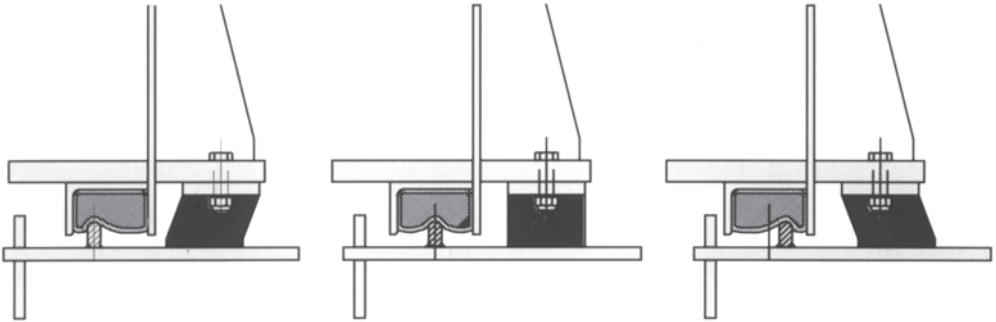

Flexipad flexes when the hatch cover and coaming move in the seaway

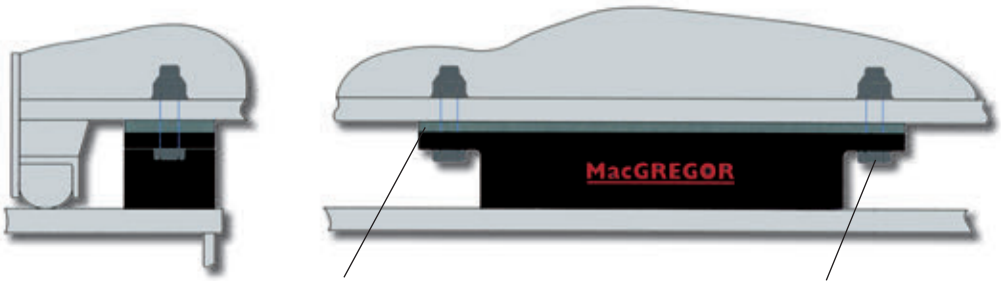

Adjusting plate

Stainless steel nut and bolt

The Flexipad installed on hatch cover

FOLDING HATCH COVERS

1. Intermediate hinge
2. Leading pair
3. Trailing pair
4. Lifting wheel for trailing pair
5. Bell crank
6. External hydraulic cylinder for bell crank
7. External hydraulic cylinder for leading pair
8. Link for end hinge
9. Longitudinal stopper

MacGREGOR

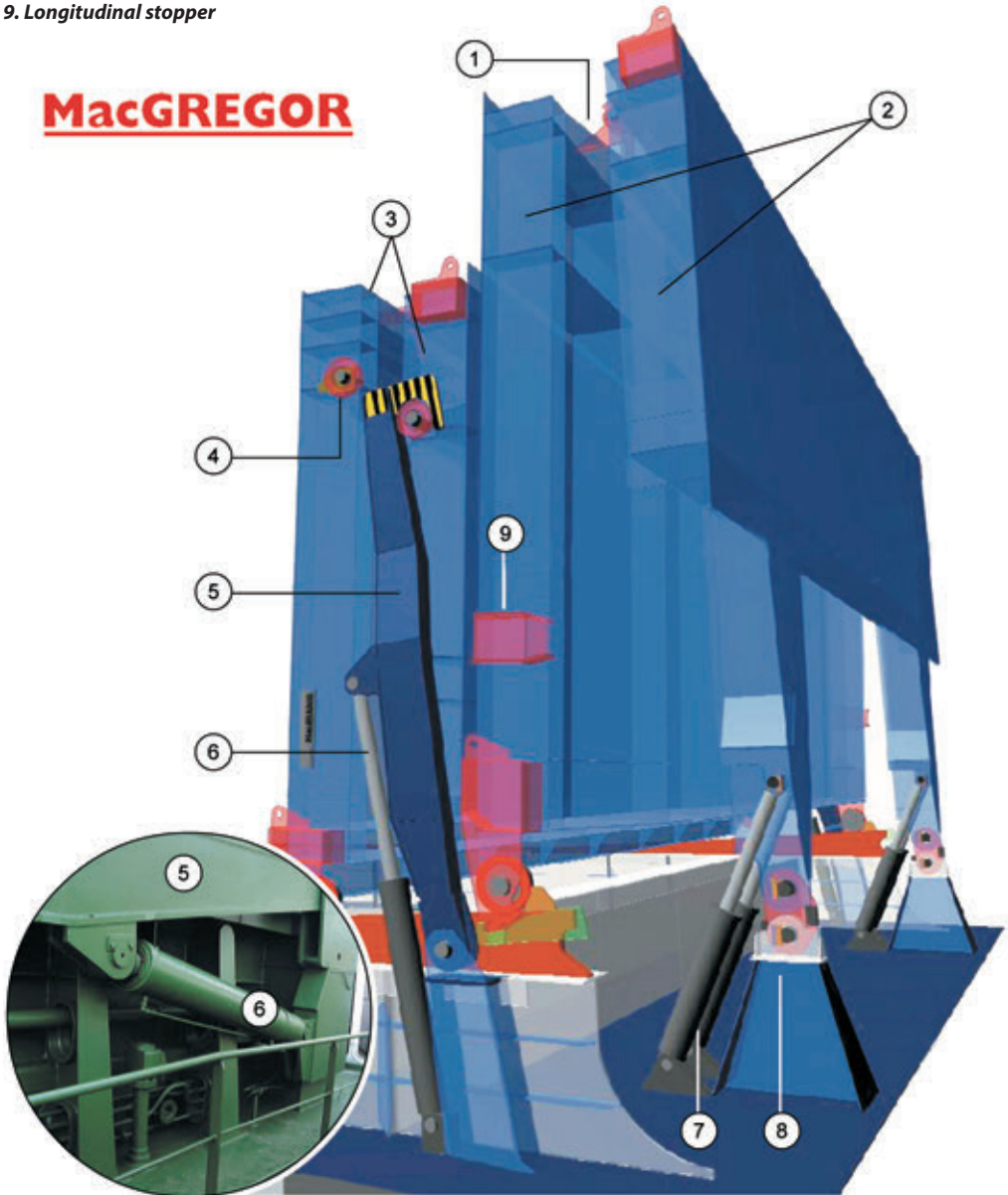

Multi-folding hatch cover

FOLDING HATCH COVERS



Photos: J. Babicz



Hatch rubber

going condition, the **beam** seals the joint, and when the hatch is open in port the panels can be handled in any order. Folding of the sealing beam can be performed by hydraulic cylinders, or manually by a ratchet or pneumatic power tool.

Hatch cover seals – The sealing between hatch covers and coaming is generally achieved by sliding rubber packing which is fitted to the panels and tightens against the top of coaming.

CAT profile – A hardwearing rubber profile developed by MacGREGOR for sealing of hatch covers.

FlexSeal – A solid rubber profile developed by MacGREGOR for sealing of hatch covers.

Hatch rubber – Alternative name for seal.

Hatch sealing tape – Any type of adhesive tape used to seal cross-joints externally.

Hatchcoverless container ship NORASIA FRIBOURG

The ship is characterised by a moulded depth greater than normal proportions, which allows eight of the 11 tiers of containers to be stowed below the deck; a “whaleback” bow shelter, acting as a **breakwater** and wind break, and a **superstructure** positioned right aft. Nos 1 and 2 holds are closed by conventional pontoons for safety reasons and enable them to carry **dangerous goods**. The special feature is the fitting of lightweight rain shelters over open holds. The shelters are secured by twistlocks and are designed to cope with ingress of water from monsoon rains. Despite their use, the drainage and bilge systems can cope with tropical rainfalls with an intensity of 150 mm/m²/h. Water is collected in gutterways and led to the bilge wells. Two pumps with a capacity of about 280 m³/h each, are installed in the engine room and an emergency bilge pump of approximately 560 m³/h is fitted in the forebody. The gutterways are able to collect up to 40 m³ of water in one cargo hold. Furthermore, the bottom container sockets are about 30cm higher than on conventional container ships. With these measures, the risk of water seeping into containers is reduced to minimum.

Length, oa: 242.00m, Length, bp: 229.50m, Breadth, mld: 32.24m, Depth moulded to main deck: 23.00m, Draught design/scantling: 11.00/12.00m, Deadweight design/scantling: 35,380/41,570dwt, Service speed at 90% MCR, 15% sea margin, design draught: 22.50 knots, Main engine MCR: 27,290kW at 102rev/min.

Hatchrails – Ropes supported by stanchions around an open hatch to prevent persons from falling into a hold.

Hawsepipe, spurling pipe – A tube through which **anchor chain** is led overboard from the **windlass** wildcat on deck through the ship side. A doubling plate is fitted around it at the **forecastle deck** and a chafing ring at the ship side.

Hawser – Synthetic or natural fibre rope or wire rope used for mooring, warping and towing.

Hazardous air pollutants (HAPs) – Also known as toxic air pollutants or air toxics, are those pollutants that cause or may cause cancer or other serious health effects, such as reproductive effects or birth defects, or adverse environmental and ecological effects. EPA is required to control 187 hazardous air pollutants.

Hazardous area – An area which, for the purpose of the installation and use of electrical equipment, is regarded as dangerous. Such hazardous areas are graded into hazardous zones depending upon the probability of the presence of a flammable gas mixture.

Hazardous substances – Chemicals that are dangerous and likely to harm people health.

Header tank – A liquid storage tank which maintains a head or gravity pressure in the system. It acts as an expansion tank and also supplies liquid to make up for system losses.

For vessels such as semi submersibles with largely differing drafts the header tanks may be pneumatically pressurized in accordance with the operating depth of the underwater equipment.

Heat balance – A statement, usually in the form of a system diagram, of the heat energy available in a system and the way it is distributed. Details of pressure, temperature and mass flow of, for example, a steam turbine cycle would be given at the various points in the system.

Heat detector – A device which can detect a fire, or a considerable change in temperature, as a result of the action of heat on a sensing element.

Heat exchanger – A device that transfers heat through a conducting wall from one fluid to another. Heat exchangers are used to transfer heat from a hotter fluid (liquid or gas) to a colder fluid. This broad definition covers a wide range of equipment, including **boilers**, **condensers**, distilling plants, and ventilation cooling coils.

Plate heat exchanger – It consists of five basic elements: the cover, the carrier rail, the heat transfer plates, the support column, and the tie bolts. The inlet and outlet for both fluids are usually located in the same cover. The fluids are separated by the heat transfer plates. Each plate contains a gasket that fits into grooves pressed in the plate and in the nozzle ports. The gasket prevents the two fluids from mixing. The gasket is vented to the atmosphere, which permits a leak to be promptly detected. The plates are sandwiched between a fixed cover and a movable cover by tie bolts. The top and bottom carrier rails align the plates to each other.

Shell-and-tube heat exchanger – Shell-and-tube heat exchanger is fabricated from round tubes that are settled in, and run parallel to a shell. Heat is transferred between the fluids by passing through the walls of tubes. This type of exchanger consists of six basic elements: the bonnet, tubsheet, shell, tubes, baffles or support plates, and the tie rods.

Heating – The process in which the ambient temperature is raised by adding heat to the air, to reach higher air temperature. Shipboard heating is carried out by different means: reheaters are used in a central-station of air-conditioning system with the cooling function turned off; reheaters and preheaters are used in supply ventilation systems; and convection or radiant heating is used in spaces not equipped with either an air-conditioning or supply air ventilation system.

Heating coils – Pipes through which steam or thermal oil passes to heat HFO or liquid cargoes in order to reduce their viscosity for pumping purposes or to maintain a required temperature.

Heaving – The up and down linear motion of a ship in the sea. See also **ship motions**.

Heaving line – A very light line that is thrown between the ship and the berth and is used to draw the **messenger line** ashore.

Heavy lift derrick – A cargo-handling device for heavy large items.

Heavy lift ships – Specialized ships capable of transporting non-standardized heavy cargoes. They can be subdivided into four main categories: project cargo ships, open deck cargo ships, dock ships, and semi-submersible ships.

As most heavy lift cargoes are unique, the management of those require very careful planning and coordination to the smallest detail. Detailed information on cargo and the location of loading and discharging are studied in the preparation phase, often before even the contract is actually booked.

PLATE TYPE HEAT EXCHANGERS

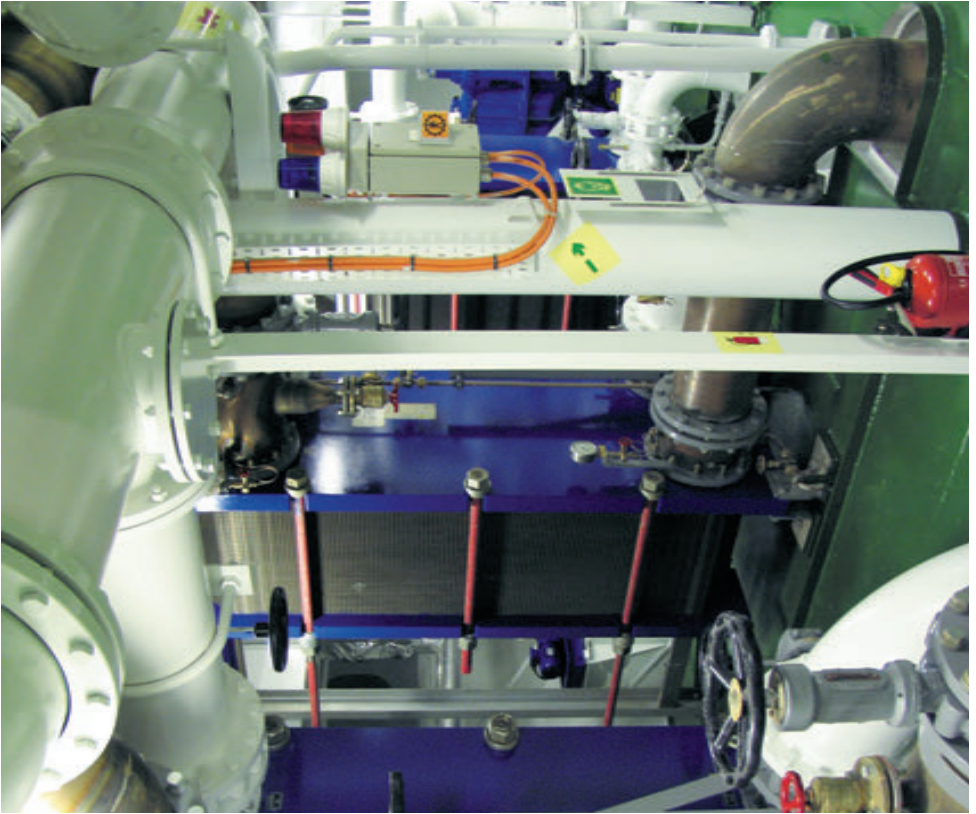

Photos: C. Spigarski

SHELL-AND-TUBE HEAT EXCHANGER

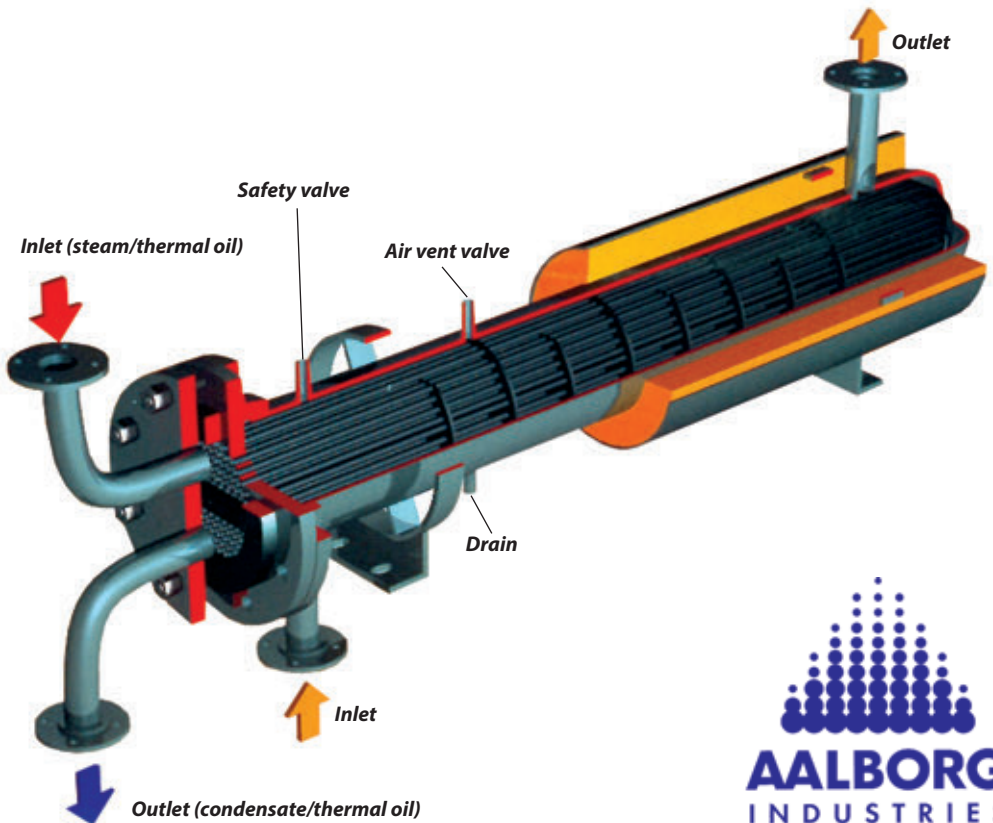
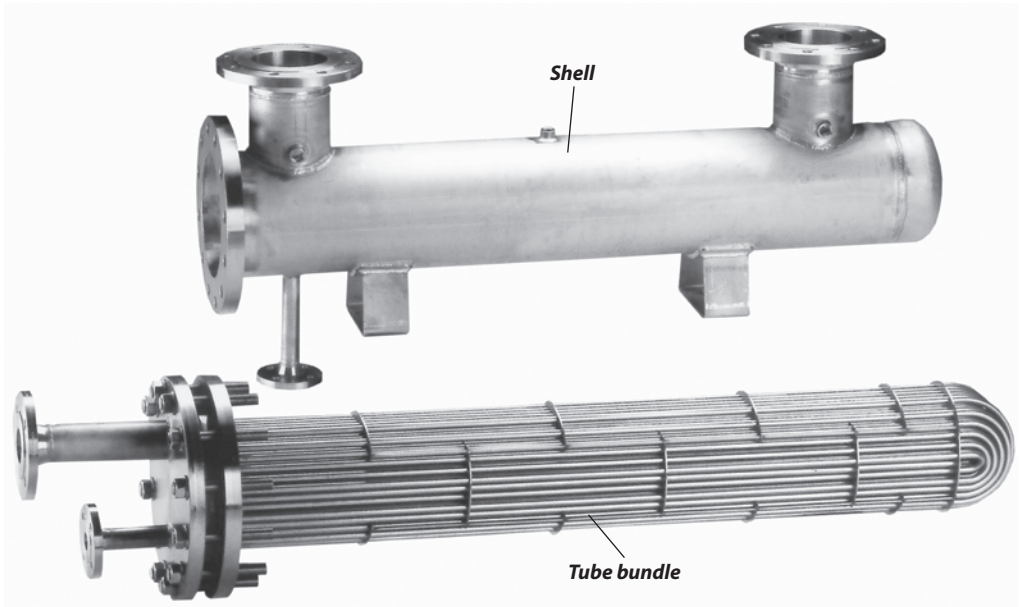

HEAVY-LIFT VESSELS



Open deck cargo ship MERI



Dock ship

HEAVY-LIFT VESSELS

Photo: T. Urbaniak



Project cargo ship

Photo courtesy of Dockwise



Semi-submersible heavy-lift vessel BLU MARLIN

Heavy lift carrier FAIRPLAYER

Many projects demand detailed operation manuals, which must be approved by a client and warranty surveyors. Stowage and lifting plans are all prepared with 2D and 3D CAD systems, whereas complicated lifting situations can be simulated step by step.

Project cargo ships – Relatively small ships, often with a large box-shaped hold, used for carrying small machinery, port equipment, locomotives, knocked down cranes, small boats and yachts.

Open deck cargo ships – **Ro-ro** type vessels with the superstructure positioned fore. They are designed for transport of large modules, fully-erected container cranes, etc, on a large open cargo deck, accessible with a full width stern ramp.

Dock ships are characterized by the full-length sidewalls protecting the cargo area. The cargo can be loaded by float-in/float-out by submersing the ship until the dock deck is under water, lift-on/lift-off, using cranes, roll-on/roll-off over the ship stern ramp.

Semi-submersible ships – Vessels that are horizontally submersible until their main deck is under water to a depth of 6 to 14m and large cargoes can be loaded using the float-on/float-off method. In this case, the load must be barge-mounted or able to float itself. The ship itself sinks similarly to a floating dock and the cargo is floated onboard. Typical cargoes are drilling rigs, floating plants, dredging equipment, offshore structures, floating drydocks, other vessels.

Heavy lift carrier FAIRPLAYER

According to HBS International November 2008

The FAIRPLAYER was built by the Damen Shipyards Galati, Romania. The ship was completed entirely in Galati, except for the fitting of the cargo cranes.

Each of the two Huisman Itrec rotating mast cranes has a safe working load of 900 tons at 27.5m. The crane booms allow a maximum reach of 35m and are equipped with three



additional hoists: a sling handling hoist (SWL10t), an auxiliary hoist (SWL37.5t) and a tugger hoist (SWL25t, 200m length). Both cranes are controlled by a small portable and wireless control panel, which allows control from anywhere on the vessel or even from the quayside. When the wireless signal from the control unit is interrupted, the crane automatically stops any activity and hold its position.

Three high-capacity ballast pumps with a capacity of 700 m³/h each can shift seawater to the relevant ballast or anti-heeling tanks in an electronically controlled process. The ballast lines are made of glassfiber reinforced plastics (GRP).

To achieve sufficient stability during twin-lifting, the vessel can place two stabilizing pontoons on either side of the hull. To maximize the leverage, the smaller pontoon can be attached on the outboard side of the larger pontoon. This pontoon is clamped onto the hull in special tracks which allow for placement at various heights. It is firmly connected with the hydraulic clamping connection.

The single cargo hold measures 102x17m in the lower part. A tweendeck can be placed at different heights between the tanktop and maindeck hatches. This can be even at different heights in different parts of the hold, to accommodate special cargoes. Usually the cargo to be shipped is so large that there is no space left on the quayside to store the hatch cover panels. Therefore, both the tweendeck and maindeck hatch cover panels are constructed as watertight pontoons and can float. This means that during cargo handling operations they can be simply placed in the water alongside the vessel until they are needed again.

The vessel is certified for sailing without hatch cover. In such case, the maximum draught allowed is reduced from 8.1m to 7.65m. Moreover, a drenching system has to be installed as the CO₂ system for the open cargo hold becomes useless.

The ship has an asymmetric accommodation deckhouse and navigation bridge, which keeps one side of the ship completely clear from stern to bow and allows for loading of extremely long cargoes.

To optimize the flow into propellers, the shaftlines are not parallel but angled 5° inboard toward the aft. Controllable pitch propellers are from Wärtsilä, with a diameter of 4350mm. Each of the main engines also drives a shaft generator through a PTO on the gearbox. These shaft generators can generate up to 3750kVA each, which is used by the bow thrusters, the azimuth thruster and the cargo cranes.

The azimuth thruster is a retractable FPP 1700kW thruster from Wärtsilä, with a propeller diameter of 2.10m. It is located on the starboard side, just forward of the aft crane. Two FPP bow thrusters, each rated at 1500kW, were also supplied by Wärtsilä.

Length, oa: 145.04m, Breadth, mld: 26.50m, Depth, mld: 14.10m, Draught design/maximum: 6.50/8.10m, Deadweight design/maximum: 8196/13,000dwt, Hold capacity: 19,800m³, Propulsion power: 9000kW, Trial speed: 17.20 knots.

Heavy load transportation system (STS) – The system used to move heavy ship modules. The first STS was installed in Bremer Vulkan Yard, Germany. It is capable of carrying completely equipped ship modules weighing up to 3800 tonnes, measuring up to 52m long, 32.5m wide and 25m high, in both the horizontal and vertical directions.

A slide system 220m long, coated to minimize friction, moves the module horizontally. It interconnects the central construction areas, such as pre-assembly, central outfitting

Heavy running of the fixed pitch propeller

hall and the building dock. After completion of the outfitting work, the ship module resting on the sledge is moved out next to the building dock on the slides and shifted transversely to a lift system installed in the building dock which lowers the module 14m to the dock floor.

Heavy running of the fixed pitch propeller – Heavy running occurs when engines reach the maximum continuous rating before they reach full rev/min. FP propellers can suffer heavy running due to propeller/hull fouling, engine ageing, too high pitch on the propeller, change in normal operating conditions or modifications to the ship. The propeller is usually designed according to the trial curve, i.e., at 100% rev/min the absorbed engine power should be from 85% to 90% MCR. Ships in service operate according to the service curve which is significantly above the trial curve.

Heavy weather damage – Damage caused to a ship as a result of sailing in heavy weather. Typically bending and buckling of forepeak, side shell and bottom structure.

Heel – The inclination of a ship to one side (see list). Also the corner of an angle, bulb angle or channel, commonly used in reference to the moulded line.

Heickel coefficient – Coefficient used to compare propulsion efficiency at the same Froude number. The higher the Heickel coefficient the better the performance (less power required to reach the same speed).

$$K = \left(\frac{\sqrt{\nabla}}{P_B} \right)^{\frac{1}{3}} \cdot V_S$$

where:

V = displacement in m³, **P_B** = engine power in kW, **V_S** = ship trial speed in m/s

Helicopter facility – A helideck including any refuelling and hangar facilities, (SOLAS).

Helideck – A purpose-built helicopter landing area located on a ship including all structure, fire-fighting appliances and other equipment necessary for the safe operation of helicopters, (SOLAS).

Helm – A tiller or a wheel generally installed on the **bridge** or in the **wheelhouse** of a ship to turn the rudder.

Helmsman – A person who steers the vessel while underway.

Helmsman's workstation (workstation for manual steering) – Workstation from which the ship can be steered by a helmsman, preferably conceived for working in seated position.

HERO (habitat environment repair option) – Underwater dry stern seal replacement system developed by the Subsea Solutions Alliance. The main element of the system is portable, flexible, dry **habitat** fitting over the entire stern seal between the **stern tube** and **propeller**. Compressed air is used to displace the seawater and provide a dry environment to carry out repairs. All work that previously was possible in drydock only can be done dockside without changes in the vessel schedule.

HiBuoy – The HiBuoy is a new mono-buoy concept developed by Hitec Marine AS for mooring and loading of tankers.

HI-FOG system – The water-mist fire-fighting system developed by Finnish company Marioff. The HI-FOG system is based on the removal of harmful smoke and gases produced by a fire, and uses specially-developed sprinkler and spray heads. Small volumes of water are sprayed at great speed in order to break through hot gases and reach the combustion source, where the system absorbs the energy of the fire and cools the surrounding hot air/gases.

High-pressure water mist can be used for both total flooding and local application in machinery spaces, as well as ducts and deep fat fryers. Contrary to CO₂, the HI-FOG system is not harmful to people and can be activated immediately to extinguish a fire. Using only water with no chemical additives for a combination of cooling and oxygen depletion, HI-FOG does not harm the environment like the banned agent **Halon** and does not create the mess and following clean up operation of foam. The system can be returned to standby without the need to visit a port and the ship is back in operation in short time.

HI-FOG MT4

“Don’t wait, activate” they are the instructions given to clients of Marioff new machinery space flooding total fire protection system, HI-FOG MT4. There is no need to evacuate personnel, seal the space or shut off the ventilation. By immediate activation, the fire is contained and extinguished in its infancy and the damage can be minimized. If the alarm turns out to be false, the system is reset and ready for use again.

HI-FOG MT4 is the most feasible alternative to “traditional” fire-fighting systems such as CO₂, foam and inert gases. The system passed successfully the latest IMO fire test requirements, as defined in MSC/Circ. 1165, adopted in May 2005. The first **classification society** type approvals have already been issued and next ones are expected shortly.

The key feature of HI-FOG MT4 is of course that it can be activated instantly a fire is detected. Furthermore, the extinguishing medium is plain, fresh water in the form of water mist, so an activation does not result in equipment corrosion. No foam or chemicals are used, so the system does not present any harm to people. The system can be tested regularly to ensure that it is always in working condition and to demonstrate its operation to the crew. Finally, there is no need to divert to a port for recharging the system, as the system uses a pump unit rather than compressed gas.

HI-FOG MT4 is a simple and robust system, using a pump unit only. No pressure cylinders are required for redundancy or other purposes. The system has been designed to provide both total flooding and local application (IMO MSC/Circ. 913), using the same pump unit, tubing and spray heads. Using one integrated system saves on component, installation, maintenance as well as training costs.

Last but not the least, HI-FOG is a highly efficient fire extinguish system. It has repeatedly proved out in real ship fires which have been extinguished in about a minute from the moment the fire started. In most cases, the ship has been able to continue without disruption to its service.

For further information visit www.hi-fog.com

High expansion foam – A foam compound, which expands during curing to fill voids.

High heat tanker BITFLOWER

According to **Significant Ships** of 2003

BITFLOWER has been designed to transport molten **bitumen**, hot pitch, and related products of transportation temperatures up to 250°C. The double-skin hull surrounds two cargo holds with a cargo tank block installed in each of them. They are constructed of semi-rigid steel and placed on composite supports on the tanktop, which allows free movement under the influence of thermal expansion, and reduces heat transmission from the tanks to the double-bottom structure. Similarly, the entire piping system is flexibly mounted so that expansion can be compensated for without the need for bellows joints. All the outside surfaces of the blocks are insulated with a two-layer system of mineral wool, partly sheeted with steel.

High heat value

Cargo is handled from a central pumproom located between the holds, using two Bornemann hydraulically-operated pumps having a maximum capacity of 500m³/h. They can draw cargo from each tank and deliver it through the cargo system to the two deck crossover lines. Filling lines link with this system, and the interconnection between suction and drop lines allow the circulation and cargo trimming between tanks. Two grades can be loaded or discharged from the tanks simultaneously. Loading/unloading systems are remotely controlled from a cargo control room, with Saab monitoring equipment measuring cargo, ballast and bunker tank temperatures, pressures and levels, and linked to a loading computer indicating stress and stability information.

Cargo heating is accomplished by two 1150kW boilers located in the engine room. They burn heavy fuel and raise, to 290°C, the temperature of the diathermic oil medium used to maintain the viscosity of the cargo at required levels. A secondary system heated by an exhaust-gas boiler, provides fluid at 180°C to serve bunker tanks, and supply auxiliary equipment and domestic users.

BITFLOWER features a **Wärtsilä Propac** machinery installation incorporating a 6L38B main engine, a reduction gearbox with Vulkan flexible couplings, and a CP propeller. The engine output is 4350kW at 600rev/min, with speed reduced by the gearbox to 155rev/min at the propeller. Electrical power is supplied from a 700kW **PTO** connected to a Stamford **alternator**, and three 700kW diesel-driven sets having Volvo prime movers. The **shaft alternator** is designed to serve as an auxiliary propulsion source, with a power-take-in (PTI) enabling the alternator to drive the propeller through the gearbox.

Length, oa: 114.60m, Length, bp: 108.90m, Breadth, mld: 16.45m, Depth, mld: 9.85m, Draught design/maximum: 6.00/6.70m, Deadweight design/maximum: 5268/6384dwt, Gross tonnage: 4890, Main engine MCR: 4530kW, Service speed at 85% MCR: 15 knots.

High heat value – Heat content of the fuel with the heat of vaporization included. The water vapor is assumed to be in a liquid state.

High-lift cylinders – Hydraulic cylinders used to lift panels of stacking **hatch covers** during operation.

High-pressure waterjet abrasive cutting – An innovative cutting process for metals, refractories, glass and many other materials. It provides a very clean cut without heat distortion, and an excellent finish.

The US Jet Edge high-pressure equipment can operate at up to well over 4000 bar on a fixed production line, or to almost 2,500 bar with a hose-dependent portable unit, producing a well-finished cut in 50-70mm plate, or at the limit cutting steel to more than 200mm.

High velocity vent, also high velocity venting valve – A device to prevent the passage of flame, consisting of a mechanical valve which adjusts the flow opening in accordance with the pressure at the inlet of the valve in such a way that the efflux velocity cannot be less than 30 m/s.

HiLoad System – A new concept for offshore loading developed by Hitec Marine AS. Off-loading is done by means of a remotely-controlled and dynamically-positioned loading terminal, capable of docking onto any standard oil tanker and keeps this at a safe distance from the exporting platform during operation.

Hogging – The tendency of a ship to arch up **amidships** as the result of improper weight distribution (too much weight put at the ends and not enough amidships).

Figure from IACS Recommendation 46: Bulk Carriers

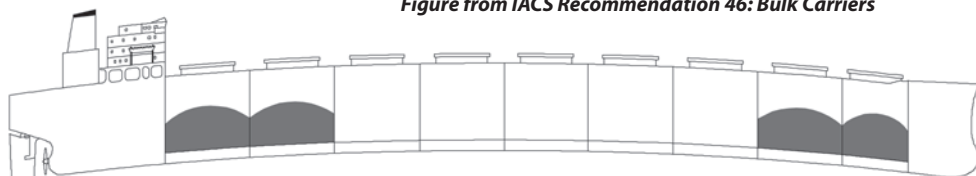
*Hogging in still water created by the wrong cargo loading*

Hoist – A cable used by helicopters for lifting or lowering persons in a pick-up operation. Also a device used for lifting or lowering a load, by means of a drum or lift-wheel around which rope or chain wraps.

Hold – A large space below deck for the stowage of cargo; the lowermost cargo compartment.

Hold space – The space enclosed by the ship structure in which an independent **cargo tank** is situated, (IBC Code).

Hold space of gas carrier – The space enclosed by the ship structure in which a **cargo containment** system is situated, (IGC Code).

Holding tank – A tank used for collection and storage of **sewage**, (MARPOL).

Holding-down bolts – The securing bolts which are usually fitted for fixing main propulsion machinery and thrust blocks.

Homogeniser – A milling machine equipped with concentric gears with conical surfaces that grind heavy fuel oil as it is pumped through the treatment system. Homogenisers are used to disperse any sludge and water remaining in the fuel after centrifuging.

Homogenisers installed before the centrifuge reduce the efficiency of the centrifuge and, thus, the cleanliness of the fuel delivered to the engine.

Hopper barge – A barge which loads material dumped into it by a **dredger** and discharges it through the bottom.

Hopper side tanks – Tanks used for ballast or for stability when carrying certain cargoes in bulk carriers. Also referred to as topside wing ballast tanks or bottom hopper tanks.

Hopper unit – A ship equipped for carrying spoils or dredged material. Split hopper unit opens longitudinally around hinges.

Horizontal fixed position (pipe welding) – The position of a pipe joint in which the axis of the pipe is approximately horizontal, and the pipe is not rotated during welding.

Horizontal rotated position (pipe welding) – The position of a pipe joint in which the axis of the pipe is approximately horizontal and welding is performed in the flat position by rotating the pipe.

Horizontal welding position (fillet weld) – The welding position in which the weld is on the upper side of an approximately horizontal surface and against an approximately vertical surface.

Hose assembly – Metallic or non-metallic hose with end fittings, ready for installation.

Hose testing – A test carried out to demonstrate the tightness of structural items not subjected to **hydrostatic** or **leak testing** and to other components which contribute to watertight or weathertight integrity of the **hull**.

Hot work – Work involving sources of ignition or temperature sufficiently high to cause the ignition of a flammable gas mixture. This includes any work requiring the use of welding, burning or soldering equipment, blow torches, some power driven tools, portable electrical equipment which is not **intrinsically safe** or contained within an approved explosion-proof housing.

HOLD

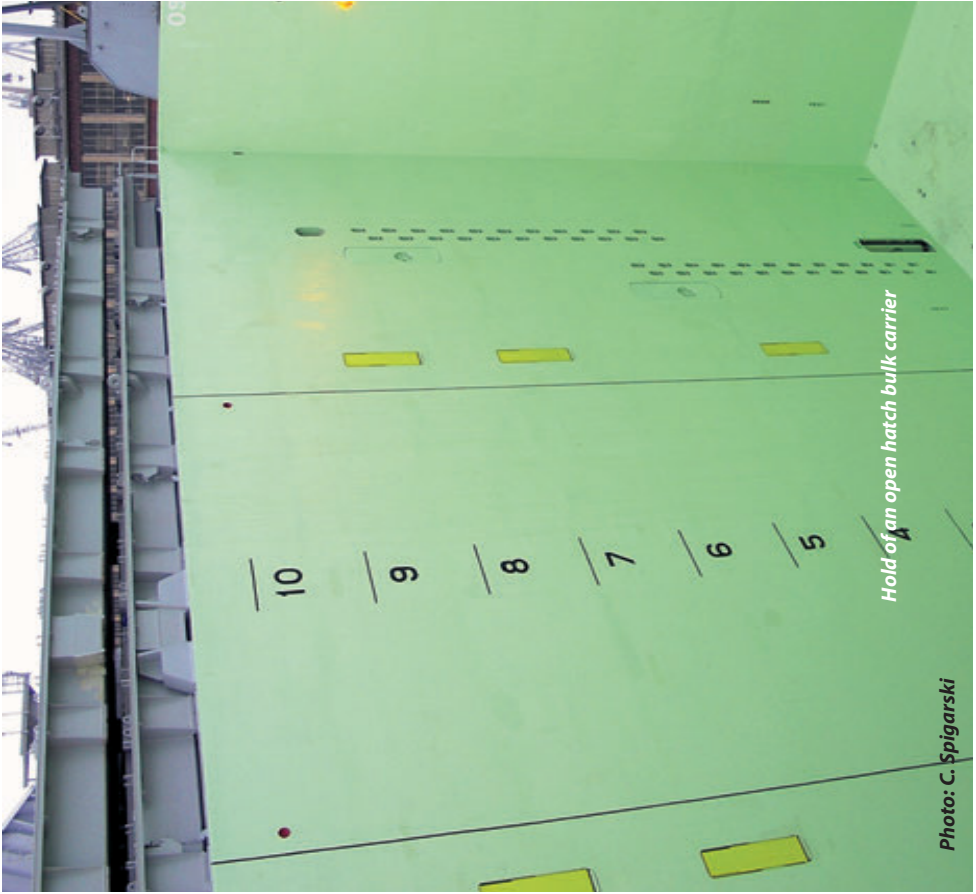

Hold of an open hatch bulk carrier

Photo: C. Spigarski



Single hold of a multi-purpose vessel

Photo: J. Babicz

Hovercraft, also air-cushion vehicle – A vessel riding on a cushion of air formed under it. It is very manoeuvrable and is also amphibious. There are two types of hovercrafts: the fully skirted and the sidewall. The most remarkable of these crafts was British Hovercraft SRN4. This large, gas turbine propelled passenger/vehicle **ferry** went into service in 1968. In its original configuration, the SRN4 could carry 30 cars on the central vehicle deck and 254 passengers in two identical side cabins. Power was provided to the four lift fans and pylon mounted propellers by four Rolls Royce Proteus gas turbines and speeds of up to 60 knots could be achieved.

HSVA Speed Trial Analysis – A speed trial evaluation method developed by the Hamburg Ship Model Basin (HSVA) in order to improve the significance of full-scale measurements. The essence of the evaluation procedure lies in the analysis of a number of interrelated and fully documented trial measurements which shall meet the following requirements:

1. At least three double runs at different engine loads, with and against the wind shall be conducted.
2. Reliable measurements of ground speed, shaft speed, shaft torque and apparent wind are to be carried out.
3. Contract conditions regarding draft, trim, hull and propeller conditions shall be met.
4. Speed trials shall be carried out in favorable environmental conditions.

For further information visit www.hsva.de

Hull – The structural body of a ship, including shell plating, framing, decks, bulkheads, etc.



*Hull of the oil spill response vessel ARKONA built by PEENE-WERFT
(note the icebreaking bow with anchor pocket)*

Hull appendages – Any protruding part of the hull structure that is below the waterline (rudder, bilge keels, thrusters, propeller brackets etc).

Hull efficiency – The ratio of thrust power to effective power, which is usually higher than one.

Hull roughness – Hull roughness is the result of fouling, corrosion, flaking of old paint, mechanical damages during service, etc.

Hull-stress monitoring system

Hull-stress monitoring system – A system of measuring stresses in selected locations of a **hull girder**. The system usually includes a database in which measurements are recorded for subsequent reference.

Humidity – A measure of the amount of water vapour in a given volume of gas. Most measurements of humidity relate to air.

Hundred-year storm – A criterion used in the design of offshore oilrigs and meant to represent most severe conditions that may occur once in a hundred years.

Hungry horse deflections – Deflections of plating in between supporting grillage.

Hydrant – The terminal point of a water main with fittings for the attachment of a hosepipe.

Hydraulic motor – A device which converts hydraulic fluid power into mechanical force and motion. It usually provides rotary motion.

Hydraulic rack and pinion – A mechanism for driving **hatch covers** to the open or closed position. It uses a **hydraulic motor** attached to the coaming to power a pinion which drives a rack fitted to the panel.

Hydro chlorofluorocarbons (HCFCs) – Compounds containing hydrogen, fluorine, chlorine, and carbon atoms. Although ozone depleting substances, they are less potent at destroying stratospheric ozone than chlorofluorocarbons (CFCs). They have been introduced as temporary replacements for CFCs and are also greenhouse gases.

Hydroblasting – The method used for cleaning of the surface to be repaired. The degree of cleaning depends on the pressure of the water jet. For achieving a complete cleaning, the removal of rust and all paint layers, a pressure greater than 1700 bar is recommended (Ultra High Pressure Hydroblasting).

Hydrocarbons – An organic compound consisting entirely of hydrogen and carbon.

Hydrodynamics – The study of the behaviour of fluids, especially incompressible ones, in motion. Hydrodynamics principles are applied to the performance of a ship in order to design the most efficient hull form which requires a minimum power for a given speed.



Hydrofoil, hydrofoil boat – A vessel with underwater wings (hydrofoils) fitted below the hull. The dynamic lift of hydrofoils keeps the hull clear of the water surface while underway. The hydrofoils provide a substantial reduction in resistance with ability to maintain speed in rough seas. The foils, attached by struts to the hull, may either pierce the water surface, or be totally submerged.

Hydrofoil Small Waterplane Area Ship (HYSWAS) – Hydrofoil craft that receives a portion of its lift from a single buoyant pod located below a traditional upper hull. The foils are

attached to the pod or “lower hull” which is connected to the upper hull by one or more low-waterplane area struts. Like a traditional hydrofoil, the HYSWAS operates on its upper hull at low speeds where the large waterplane area provides the vessel with the necessary hydrostatic stability. As speed increases, the foils generate sufficient lift to raise the upper hull out of water and stabilise it in the presence of roll and pitch moments exerted by the sea and wind.

Hydrographic survey vessel – A vessel equipped with hydrographic survey equipment to determine underwater topography in order to produce high-precision charts. This shows that, among other things, it has to be able to measure water depth (soundings), to scan the seabed in order to locate wrecks and other underwater obstacles, and verify the exact position of buoys and other markers. To enable the vessel to perform its tasks in shallow waters, it is equipped with **survey launches**, acting as “**daughter-vessel**”, collecting data needed on the mother ship.

Hydrostatic curves – A series of graphs drawn to a vertical scale of draught and a base of length, which gives values such as the centre of **buoyancy**, **displacement**, moment causing unit trim, and **centre of flotation**. In practice tables with hydrostatic parameters calculated for different draughts are used. However, only having traditional graphs it is possible to observe character of hydrostatic curves and understand ship behaviour.

Hydrostatic release unit (HRU) – A part of the **lifteraft** lashing used for automatic liferaft release. At up to 4m water pressure activates release mechanism and the liferaft is free to float clear to the surface. HRUs may be either of the disposable type, in which case they are replaced every 2-4 years, or they can be of the type that has an unlimited life provided they are serviced and tested (normally every year).

Note: A liferaft stowed forward at a distance of over 100m from other survival craft does not need be fitted with an HRU. This is because the unit may release the liferaft after becoming submerged in heavy bow seas.

Further reading: MGN 343 Hydrostatic Release Units (HRU) - Stowage and Float Free Arrangements for Inflatable Liferrafts

Hydrostatically-balanced loading (HBL) – Cargo tanks on oil **tankers** are loaded to 98% and in some cases 99% of capacity with the oil level well above the sea level. If the hull plating is breached, then due to the pressure of the oil on the ship bottom being greater than the pressure of the sea, oil will flow out causing pollution. When HBL method is used, the oil pressure on the ship bottom is equal to or less than that of the sea on the ship bottom. In this situation when the hull is breached, the sea flows in preventing pollution.

HYKAT – The large hydrodynamic and **cavitation** tunnel of the Hamburg Ship Model Basin HSVA. In HYKAT, propeller cavitation tests and propulsion optimization tests are performed with complete ship models to create a proper three-dimensional **wake field** for the **propeller**. The wake fraction and the relative rotative efficiency can be determined similarly to a self-propulsion test in a **towing tank**. The main advantages of these tests compared to towing tank tests are the higher Reynolds numbers and the ease with which the velocities and the propeller loadings can be varied.

For further information visit www.hsva.de

Hyperbaric evacuation system – A system allowing for the divers under pressure to be safely evacuated from a ship or floating structure to a position where decompression can be carried out.



Cavitation test in HYKAT

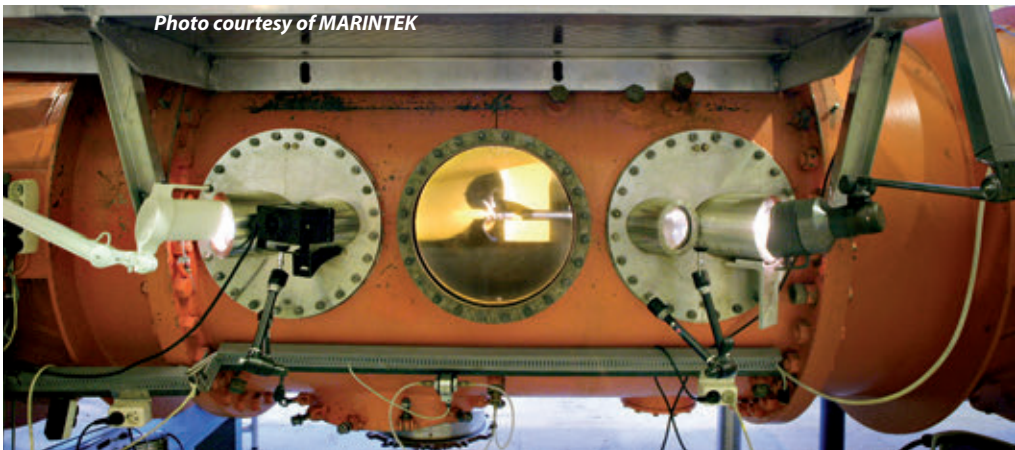

Cavitation tunnel

Hyperbaric facility – A chamber or combination of chambers, intended for manned operation at internal pressure above atmospheric.

Hyperbaric lifeboat – A self-propelled lifeboat intended for human occupancy in saturated conditions.

Hyperbaric rescue capsule – A free-floating decompression chamber for human occupancy. It can be maintained with gas mixture under a pressure. In case of emergency, it is launched from a vessel, a rig or a platform in distress and may drift free.

IBC Code – see **International Bulk Chemical Code**.

Ice belt – The ice-strengthened area of the shell plating, usually divided into the forward region, the midship region and the aft region. On the shell expansion plan, the location of maximum and minimum ice draughts, upper/lower limits of the ice belt, as well as the regions are to be indicated.

Ice class – A class notation given to vessels, which have additional strengthening to enable them to operate in ice bound regions.

Further reading: ABS Publication “Ice Class” (2005), can be downloaded from www.eagle.org

Ice class rules – For the operation in the Baltic, the Finnish-Swedish Ice Class Rules (FSICR) and the Russian Maritime Register (RMR) Ice Class Rules (Non-Arctic Sea Area Requirements) are applied. In the Arctic Ocean, it is RMR Ice Class Rules and the Canadian Arctic Shipping Pollution Prevention Rules (CASPPR); while the RMR Ice Class Rules (Non-Arctic) apply in the Okhotsk Sea.

The aim of all ice rules is to ensure safe operation in ice by focusing on the strength of the hull structure and protecting of essential propulsion machinery under ice interaction loading scenarios, and by stipulating sufficient installed propulsion power. In practice, this means heavier scantlings in the side shell structure (**ice belt**) and a bow shape optimised for ice operation; a larger diameter shaft and thicker propeller blade root; and provision of an ice knife to prevent damage to **rudder** and **steering gear** when manoeuvring in ice.

Ice strengthening – Ships intended for navigation in ice conditions are specially reinforced. Ice strengthening concerns the side shell structure, stem, stern frame steering gear, propeller and shafting.

Further reading: ABS Guide for “Non-Linear Finite Element Analysis (FEA) for Side Structures Subject to Ice Loads”

Ice thickness

Area	Thickness (cm)	Ice type
Baltic (Gulf of Finland/Gulf of Bothnia)	40/80	One year ice
Caspian Sea	70	One year ice
Azov Sea (Black Sea)	70	One year ice
White Sea	80	One year ice
Barents Sea (Arctic)	120	First and multi-year ice
Sea of Okhotsk (East Siberia/Sakhalin)	140	First and multi-year ice
Kara Sea (Arctic)	180	First and multi-year ice

Temperature in the Baltic, typically –15°C. Temperature in the Arctic, down to –40°C.

Icebreaker – A vessel used for keeping a navigable passage open through ice. Icebreakers are grouped in ice classes according to the thickness of the ice to be broken. They are heavily built to withstand the shock of ramming the ice or of running up on it at the bow and breaking it by virtue of their weight. Icebreakers are provided with several propellers, not merely at the stern, but sometimes also in the fore part of the ship. Air-bubbler system becomes a part of the standard equipment of a modern icebreaker. This process

Icebreaker/offshore vessel BOTNICA

involves the expulsion of compressed air through holes in the lower part of the hull. The ascending bubbles then loose ice pieces reducing the ship resistance through the ice. The **thrusters** can be used to create a propeller wave, which pushes the broken ice away from the hull and creates a wider channel.

The patented icebreaking solution, ARC 100 concept, which has been developed by Aker Arctic Technology, features the oblique (sideway) design with an asymmetric hull and three Steerprop pulling azimuth propulsors that allow the vessel to maneuver effectively in all directions. Oblique icebreakers are able to operate obliquely with sideways movements as well as ahead and astern.

The first oblique icebreaker, Aker Arctic's ARC 100, is due to be delivered by Arctech Helsinki Shipyard in 2014. The hull form has an unique design and can proceed in 1.0m thick ice ahead and astern. In the oblique mode the vessel will be able to forge a 50m wide ice channel in 0.6m thick ice.

Icebreaker/offshore vessel BOTNICA

Finland is entirely dependent on icebreakers to keep its trade routes open in winter. Icebreakers are normally in operation from mid November until the end of May. Traditionally, icebreakers have been unemployed outside the winter season. In the early 1990s, the Finish Marine Administration began to look at alternative configurations to see if an effective icebreaker could be combined with enough flexibility to be employable elsewhere. The first result was the combined icebreaker and offshore vessel FENNICA put into service in 1993 followed by a sister ship NORDICA in 1994. They have proved to be very successful and this experience has led to the construction of the BOTNICA.

Photo courtesy of STX Europe



The new vessel is somewhat smaller than its predecessors. FENNICA and NORDICA were 116m long with a beam of 26m and 15 megawatts of propulsion power, fed through two azimuth **thrusters**. BOTNICA is 96.7m long with a 24m-beam. The total engine output is 15MW but under normal conditions 10MW is used for propulsion. The latest technology has been incorporated and BOTNICA is notable for two **Azipod** units which provide a **bollard pull**

of 105t and a free running speed of 15 knots. The ship is capable to maintain a continuous speed of 4 knots ahead in 1.2m thick ice and the speed of 8 knots in 0.60m ice.

In winter, the ship operates as an icebreaker, in summer is used for subsea intervention. The vessel is able to carry out slim hole drilling, **ROV** support. It can also carry out towing operations and provide cargo and equipment supply. BOTNICA includes many features already seen in two earlier vessels from Finnyards. In particular, the hull form is comparable, with its raked bow, forward and aft **skeg**, angles and partial chines in the underbody and the forebody, which steps in to a narrower aft section. Together, these features give excellent icebreaking capability combined with the necessary **stability**, **seaworthiness** and low motions for the offshore work.

The two Azipod propulsors are supplemented by three Brunvoll tunnel **thrusters** in the forward skeg. Power for all units and the ship services and auxiliaries is generated by six generator sets housed into two separate engine rooms and arranged in a staggered formation to leave room for 6.5m by 6.5m **moonpool** in the middle of the ship.

BOTNICA has four level **accommodation** that provides space for the **crew** and additional staff for specialized offshore operations. Over the foredeck accommodation there is a helicopter platform. The aft deck is equipped with a 30m-high derrick over the moonpool and a 160t Hydrolift crane.

Icebreaking PSV VITUS BERING

VITUS BERING is the icebreaking platform supply and emergency rescue vessel built by Arctech shipyard at Helsinki.



Photo courtesy of Arctech Shipyard Helsinki

Covered foredeck protects the mooring equipment from icing



Photo courtesy of Arctech Shipyard Helsinki

A double acting ship, VITUS BERING is designed to be able to break ice both ahead and astern

VITUS BERING is 99.9m long overall. Her hull has a moulded breadth of 22.1m and depth of 11.00m to upper deck. When loaded to a draught of 7.90m, the deadweight of the ship is 4158dwt.

The vessel has been designed to withstand the harsh environmental conditions in freezing temperatures of around -35°C and is capable of operating independently on ice that is 1.7m thick, while maintaining a speed of 3kn. The vessel is capable of passing through ice ridges as deep as 20m.

Besides icebreaking, the vessel has also been designed to carry out rescue operations for 195 people, oil spill containment operations and fire fighting, and carry various goods. The vessel is also equipped with a Glonass satellite navigation system and a dynamic positioning system. The four Wärtsilä diesel generating sets have a combined output of 18,000kW and provide power for all shipboard consumers, including two 6.5MW ABB Azipod propulsion units.

ICEPOD – An azimuthing, pulling thruster developed by Wärtsilä and designed to 1A Super Ice Class or higher standards. The thruster structure and propeller are engineered for the high ice loadings borne when running both astern and forward in level ice, and when encountering large ice blocks and penetrating ice ridges stern-first. ICEPOD has been conceived with special consideration of shallow draught requirements and of installation space limitations. The Z-drive configuration permits a low-height, inboard thruster room, maximising hull volume utilisation or working deck area. The rigid mounting can is shaped to form an integral part of the icebreaking aftship section.

An additional design consideration was the particular challenge of dealing with technical problems when operating in remote areas, with the result that the thruster can be removed or exchanged without the use of a drydock or habitat. Given the particular environmental sensitivity of ice-laden regions, a four-lip seal has been adopted to prevent oil leakage, water ingress and oil contamination. The high-end seal system is well suited to shallow draught conditions.

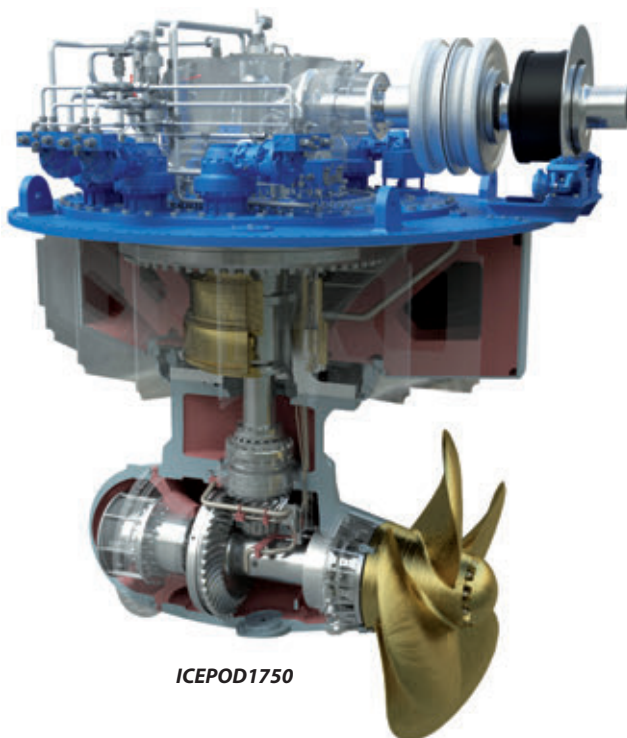

ICEPOD1750

Photo courtesy of Wärtsilä Corporation



Research vessel SIKULIAQ

Wärtsilä provided the first- ever ICEPOD for the University of Alaska Fairbanks. The two can-mounted ICEPOD2500 thrusters were delivered in the first quarter of 2012 for the research vessel SIKULIAQ. In the same year the ice-breaking multipurpose support vessel SANABORG equipped with two ICEPOD1750 thrusters was delivered by Royal Niestern Sander.

Icing

Icing – Icing caused by freezing sea spray or snow forming a layer of ice on deck and superstructure when operating in low temperatures may have major impact on the safety and general operation of a vessel.



Ice accumulation can completely disrupt the functioning of certain deck equipment. The typical icing problems to be encountered are the impairment of stability due to the lifted center of gravity, limitation of safe navigation caused by antennae and radar equipment being out of operation and icing on **wheelhouse** windows.

Note: For any ship operating in areas where ice accretion is likely to occur, icing allowances should be included in the analysis of conditions of loading. Allowance for ice accretion and guidance relating to ice accretion can be found in the 2008 IS Code.

Icon – A graphic symbol.

I-core panels – Laser-welded sandwich panels, developed by Macor Neptun and Meyer Werft, used as a deck construction material. I-core has a high stiffness-to-weight ratio and offers benefits in terms of both height and weight. A standard panel measures 3m x 10m and is 45mm thick, with a specific weight of 53kg/m².

Ignition – The setting on fire of an explosive mixture, usually within an engine cylinder.

Ignition delay – The period between the beginning of fuel injection into an engine cylinder and the beginning of combustion. See also **Retarded injection timing**.

Illuminance – The amount of light falling on an object or surface. Illuminance is measured in units of Lux (lm/m²).

Red or low-level white illuminance – Lighting provided to accommodate efficient dark adaptation in areas where seeing tasks are performed during nighttime operations and in areas where people need to move from a lit interior into a dark environment and maintain good vision.

Immersion – The change in draught resulting from the addition or removal of the particular mass. In SI system it is called tonnes per centimetre immersion, TPC.

Immersion suit, also survival suit – A protective suit that reduces the body heat-loss of a person wearing it in cold water, e.g. when rescuing someone from the sea. A dressed person in seawater at 0°C can get exhausted in minutes and die in a quarter to three-quarters of an hour. Immersion suits are designed to prevent crewmembers from death due to exposure and hypothermia. To do this, a suit must cover all the body and its extremities, except the face, with highly insulating waterproof material.

Immersion suits are intended primarily to ensure thermal protection in the cases where it is impossible to embark a fully enclosed lifeboat. Immersion suits should not be worn



when boarding fully enclosed lifeboat. The experience gained after the January 2007 abandonment of the containership MSC NAPOLI shown the potential risks resulting from wearing immersion suits in fully enclosed lifeboat. Although outside temperatures were frigid, the members of the crew who wore immersion suits suffered from overheating and dehydration.

IMO – see **International Maritime Organization**.

IMO Instruments – Conventions and other mandatory documents such as codes referred to in conventions.

Impeller – A rotating member of a turbine, blower, fan, pump, or water **propulsor**.

Impressed current cathodic protection (ICCP) – A controlled **cathodic protection** of the hull against corrosion. The system incorporates a rectifier which supplies an automatically-regulated direct current to the permanent anodes. The use of ICCP is increasing and the applications now available include: hull protection, **thruster tunnel** protection and **waterjet** protection.

For further information visit www.mme-group.com

In the impressed current method, the protective current is generated with DC power source. In this case, the anodes are most often made of more noble, inert materials, typically MMO (Mixed Metal Oxides) or titanium.

In water survey (IWS) – The survey of hull plating undertaken in the water. The ship is provided with marks placed on the shell to show borders of tanks, cofferdam etc. Hull plating should be cleaned by a diver-operated machine. A remotely-operated underwater TV camera is used to view the ship plating.

IWS can be also applied for checking that the seal assembly on oil lubricated **stern tube** bearings is intact and for verifying the clearance or wear-down of the stern bearing. For that, an opening in the top of the seal housing and a suitable gauge should be provided for checking the clearance by the divers.

Inclining test – The experiment performed to determine the ship vertical center of gravity. It consists of shifting a series of known weights transversally across the deck when the ship is

free to heel. The resulting change in the equilibrium angle of heel is measured by the shift of a plumb-bob along a batten or by a U-tube. By application of this information and basic naval architecture principles, the ship vertical center of gravity (VCG or KG) is determined.

In service inclining test system (ISITS) – A ship specific equipment consisting of a computer, a computer program and measuring devices, control devices and protocol devices. ISITS serves as an aid in determining the actual GM at the time the test is carried out.

Indent – Deformation of structural members caused by out of-plane loads like bottom **slamming** and bow impact forces, contact with other objects, etc.

Independent – “Independent” means that a piping or venting system, for example, is in no way connected to another system and that there are no provisions available for the potential connection to other systems, (**IBC Code**).

Independent tank – see **Cargo tank**.

Indicated power – The power developed in an engine cylinder. It is determined from an indicator diagram and certain basic information about the engine.

Indicator diagram – The pressure-volume diagram produced by an engine indicator.

Indirect expansion system – A refrigeration system in which a secondary coolant is cooled by the direct expansion of a primary refrigerant and is then circulated to cool the medium which absorbs heat from the space to be cooled.

Indirect injection engine – A type of engine in which the fuel is not injected into the main combustion chamber, but is injected into a prechamber instead.

Industrial vessels – Ships designed to perform specialized marine functions such as fishing, drilling, cable or pipe laying, often requiring specialized personnel.

Inert condition – A condition in which the oxygen content throughout the atmosphere of a tank has been reduced to 8 per cent or less in volume by the addition of **inert gas**.

Inert gas – Gas or a mixture of gases containing insufficient amount of oxygen to support the combustion of hydrocarbons, a gas or a mixture of gases which will not react with the cargo. Inert gas may be produced by boilers (**flue gas system**), **inert gas generators** with independent burners, **nitrogen generators** or other equipment. The inert gas is used onboard gas tankers for various purposes including the drying and inerting of the cargo tanks prior to cooling-down or after heating, the gas freeing and scavenging of the cargo piping, the topping-up of the cargo tanks to prevent the ingress of air when carrying some specific substances and to provide the environmental control of atmosphere around cargo tanks.

Further reading: IMO Guidelines for Inert Gas Systems.

Inert gas blower – Blowers are used to deliver the scrubbed flue gas to the cargo tanks. At least two blowers shall be provided.

Inert gas generator (IGG) – A device, similar to a boiler, in which fuel is burnt to create exhaust gases which contain less than 5% oxygen. Inert gas generator consists of a combined burner and **scrubber**, both seawater-cooled. Marine diesel or heavy fuel oil is burnt to produce flue gas with oxygen content of 2-4%. The gas then enters the scrubber part, where it is cooled and cleaned by sprayed seawater before being led to the deck area.

Inert gas production plants

1. Flue gas system

If available, flue gas from ship boilers can be used for inerting. The flue gas system washes and cools the boiler flue gas, and delivers it to the cargo tanks during cargo unloading

and tank washing. As the flue gas already contains less than 5% oxygen, no further treatment is therefore necessary. This system is primarily used on crude oil **tankers**. The main components are the **scrubber** unit, inert gas blowers, the deck water seal, the pressure/vacuum breaker, valves, instrumentation and the control system. Surplus gas is automatically circulated back to the scrubber unit. The system can also be preset to deliver fresh air for gas-freeing purposes.

2. Flue gas system with topping up generator

Another solution is flue gas system with topping up generator. This alternative method consists of a flue gas system supplemented by a separate small (500Nm³/h) inert gas generator. The flue gas system covers the bulk of the inerting during cargo unloading, and the generator tops up tank pressures during the sea voyage.

3. Inert gas generator systems

Inert gas generator systems are applied when no existing supply is available. These systems produce and distribute inert gas based on combustion of hydrocarbon fuels and are widely used by ships transporting **crude** oil and refined products that can tolerate water vapour and carbon dioxide.

Components of the inert gas generator systems for tankers are:

- Inert gas generator.
- Blower units which supply combustion air to the generator.
- Deck water seal which prevents the back flow of hydrocarbon gases to unsafe areas.
- Pressure/vacuum breaker that releases excessive pressure/vacuum from the cargo tanks.
- Deck distribution system.
- Control system.



Inert Gas System

Inert gas system – A system of preventing any explosion in the cargo tanks of a tanker by replacing the cargo, as it is pumped out, by an **inert gas**, sometimes by flue gas from ship

Inerting

boilers. **Gas freeing** must be carried out subsequently if workers have to enter the empty tanks.

Further reading: *IMO Guidelines for Inert Gas Systems, ABS Guide for Inert Gas System For Ballast Tanks* can be downloaded from www.eagle.org.

Inerting – Creation of an inert atmosphere in tanks or in the surrounding void spaces to prevent explosive conditions, reduce corrosion or detect leakage.

See also **Environmental control**.

Inflammable liquids – Liquids liable to spontaneous combustion giving off inflammable vapours at or below 80 degrees F. For example: ether, ethyl, benzene, gasoline, paints, enamels, carbon disulfide, etc.

Inflatable appliance – An appliance which depends upon non-rigid, gas-filled chambers for buoyancy and which is normally kept uninflated until ready for use.

Inflated appliance – An appliance which depends upon non-rigid, gas-filled chambers for buoyancy and which is kept inflated and ready for use at all times.

Inhibitors – Substances used to prevent or retard a chemical or electro-chemical reaction, often used to render corrosion products less soluble and thereby tending to restrain electro-chemical processes.

Injection – The process of spraying fuel into an engine cylinder by an injector.

Injector, fuel valve – A device which receives pressurized fuel as a liquid and sprays it into an engine cylinder as a fine mist. It consists of a nozzle and nozzle holder or a body. The nozzle has a series of small holes around its tip. The fuel is sprayed into the engine cylinder through it.

INMARSAT – The Organization established by the Convention on the International Maritime Satellite Organization adopted on 3 September 1976.

Inner bottom, also tank top – Plating forming the top of the **double bottom**.

Inner hull – The innermost plating forming a second skin of the ship hull.

In-Sea Equipment – Any equipment deployed from the **survey vessel**, towed or normally attached.

Insert plate – A steel plate of greater thickness which is fitted at a region of increased stress, e.g. hatch corner.

Instantaneous rate of discharge of oil content – The rate of discharge of oil in litres per hour at any instant divided by the speed of the ship in knots at the same instant.

Institute of Marine Engineers, since 2000 The Institute of Marine Engineering, Science and Technology (IMarEST) – A London-based organisation formed in 1899 to promote the scientific development of all aspects of marine engineering. The Institute of Marine Engineers publishes regularly technical papers relating to marine engineering and associated subjects and organises many international conferences.

Homepage: www.imare.org.uk

Instrument – A device which provides a measurement or indication of the quantity measured.

Instrument air – Compressed air which is suitable for use in pneumatic control equipment. It must be free of oil and dust and dry enough to ensure that no water condenses anywhere in the system.

Instrumentation – A system designed to measure and display the state of a monitored parameter and which may include one or more of sensors, read-outs, displays, alarms and means of signal transmission.

Insulated container – A container insulated on its walls, roof, floor, and doors, to reduce the influence of external temperatures on the cargo.

Insulated container tank – The frame of a container constructed to hold one or more thermally-insulated tanks for liquids.

Insulating flange – A flanged joint incorporating an insulating gasket, sleeves and washers to prevent electrical continuity between pipelines, hose strings or loading arms.

Insulation of ship structures – Decks, bulkheads and walls are very often covered by insulation materials in order to provide acoustic, fire or thermal insulation.

Insulation material – Rockwool, polyurethane, Styrofoam, glass fibre or other material used for insulation.

Insulation of cargo spaces – The cargo holds on board **trawlers**, reefers and deep-freeze vessels are usually insulated with **polyurethane foam** and finished with special waterproof glued plywood. Instead of polyurethane foam, mineral wool can be applied or the combination of both. The insulated floor, in most cases, is finished with glassfibre-reinforced polyester.

Insulation of hot surfaces – All exposed surfaces which personnel are likely to come in contact with are to have temperatures that do not exceed 71°C. If this cannot be achieved, the exposed surfaces are to be insulated or shielded. Insulation is to be protected from weather, oil spillage, mechanical wear, and physical damage.

Insulation space of gas carrier – The space, which may or may not be an **interbarrier space**, occupied wholly or in part by insulation.

Intact stability criteria – Analyzing the data of vessels that behaved well, and especially the data of vessels that did not survive adverse conditions, various researchers and regulatory authorities defined criteria for deciding if the stability of a vessel is satisfactory. Therefore, it is important to understand that the existing stability regulations are codes of practice that provide reasonable safety margins without giving 100% guaranty that the vessel which meets the requirements can survive all challenges.

According to the **International Code on Intact stability, 2008**, the following criteria are mandatory for passenger and cargo ships constructed on or after 1st January 2010:

1. The area under the righting lever curve (GZ curve) should not be less than 0.055 metre-radians up to 30° angle of heel.
2. The area under the righting lever curve (GZ curve) should not be less than 0.09 metre-radians up to 40° angle of heel or the angle of downflooding if this is less than 40°.
3. The area under the righting curve between the angles of heel of 30° and 40° or between 30° and the angle of downflooding if this angle is less than 40°, should not be less than 0.03 metre-radians.
4. The righting lever GZ should be at least 0.20 m at an angle of heel equal to or greater than 30°.
5. The maximum righting arm should occur at an angle of heel preferably exceeding 30° but not less than 25°.
6. The initial metacentric height GM_0 should not be less than 0.15 m.
7. **Severe wind and rolling criterion** (weather criterion)

In addition to the criteria described above, ships covered by the 2008 IS Code should meet a weather criterion that considers the effect of strong beam wind and waves applied when the vessel is in dead ship condition.

Further reading: "Ship Stability in Practice"

INTAKEMATIC – An electrolytic anti-fouling protection system designed by Wilson Taylor especially for seawater intakes. The fully-automatic system supplies a direct current to copper alloyed anodes installed in the seawater intakes or sea chests, to prevent both bio-fouling and corrosion.

Integrated bridge systems (IBS) – A series of interconnected and closely grouped screens and modules allowing centralised access to navigational, propulsion, control and monitoring information. The aim of IBS is to increase safe and efficient ship management by the qualified personnel. See also **Control and Communication Centre (3C)**

Integrated Full Electric Propulsion (IFEP) – The use of a common power system for both propulsion and ship services. Efficient operation is obtained by the use of the minimum number of prime movers which are necessary to meet the required load, all running near their optimum efficiency, selected from a relatively large number of smaller units. See also **Wärtsilä LLC System**.

Partial Integrated Electric Propulsion has been employed with considerable success in the Single Role Mine-Hunters for the British Royal Navy. The first of this class, HMS SANDOWN, entered service in 1989. Partial Integrated Electric Propulsion was also selected for the Type 23 in a CODAG configuration. The first of class, HMS NORFOLK, was commissioned in 1990. The first full IFEP ships for the Royal Navy are the Auxiliary Oiler (AO) and the Landing Platform Dock (Replacement) HMS ALBION.

Integrated monitoring system – The combining of all the individual control systems in a plant into a single computer-controlled system. This would include all aspects of navigation, cargo control, machinery control and also administrative systems on a ship.

Integrated Propulsion Package (IPP) – The IPP system consists of the CP propeller, the shaft line, the gearbox with built-in hydraulic system and the control system. See **PROPAC**.

Integrated system – A combination of computer-based systems which are interconnected in order to allow the communication between computer system and monitoring, control, and vessel management systems; and to allow centralized access to information and/or command/control.

An integrated system may consist of systems capable of performing passage execution (e.g. steering, speed control, traffic surveillance, voyage planning); machinery management and control (e.g. power management, machinery monitoring, fuel oil/lubrication oil transfer); cargo operations (e.g. cargo monitoring, inert gas generation, loading and discharging); etc.

Interbarrier space of gas carrier – The space between the **primary** and the **secondary barrier**, whether or not completely or partially occupied by insulation or other material, (IGC Code).

Intercooler – A heat exchanger fitted between the stages in an **air compressor** in order to cool the compressed air.

Intercostal – Made in separate parts; between floors, frames or beams, etc; the opposite of continuous.

Interface –

1. A boundary between oil and water.
2. A transfer point at which information is exchanged. Interfaces may be classified as: input/output interface (for interconnection with sensors and actuators); communications interface (to enable serial communication/networking with other computers or **peripherals**).

3. User interface: the aggregate of means by which people interact with a machine, device, computer program, or other complex tool.

Interface detector – An electrical instrument for detecting the boundary between oil and water.

Intering™ Anti-heeling Systems – The air- or pump-activated inclination equalising systems operating during loading and unloading, in order to keep heel as low as possible. The Intering anti-heeling system uses a constant pneumatic air purge and regulating valve system to force air into the top of one tank while venting the other one on the other side. This rapidly transfers water from one side of the vessel to the other, creating a righting moment which compensates for heeling forces. Systems up to 5000 tm/min are in operation and can be supplied as either stand alone air blower-activated, combined with tank stabilizers, pump-activated, with dedicated heeling pump or integrated into the ballast system.

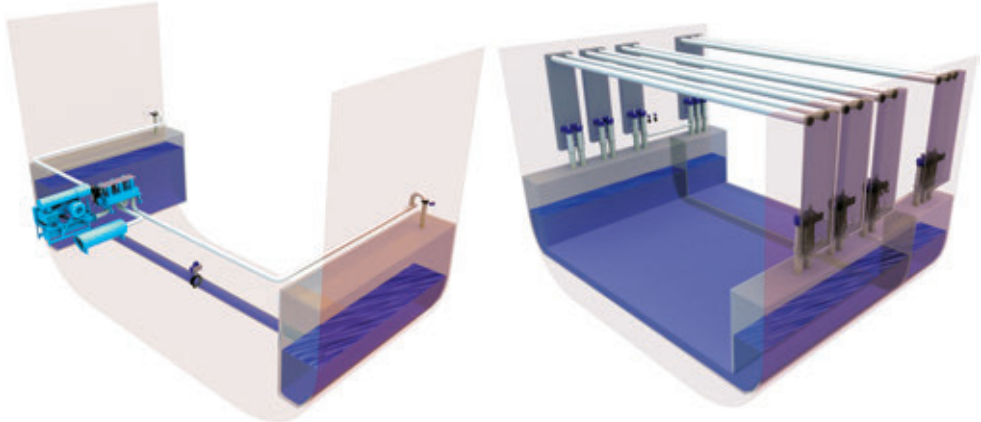

Illustrations courtesy of Rolls-Royce

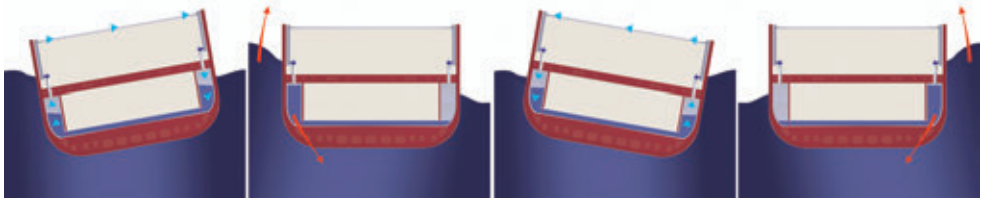

On the train ferry MECKLENBURG VORPOMMERN, three air blowers, 350kW in total, ensure that the heel is limited to less than 1deg when 600t trains are shunting at 6 km/h. This requires immediate reaction on the heel and fulfilment of a high water transfer capacity. Frequent current peaks by motor starts are avoided since the blowers are running permanently during operation. Four heeling tanks provide a total anti-heeling moment of 7780tm. The system operates with no moving parts in contact with water, which guarantees extremely high reliability and little maintenance. At sea, the system is also used for wind list compensation.

The ferry SCHLESWIG HOLSTEIN is fitted with the Intering anti-heeling system. The system is powered by two root-type air blowers, 84kW each, to compensate for a 290t train shunting within 0.7 minutes. The capacity of the tanks provides 1830tm anti-heeling moment. Four remote control panels are fitted on the bridges and near each bow visor. The Intering stability test system allows the crew to check out the actual stability of the loaded ship.

Intering™ Stability Test System (ISTS) – Automatic in-service inclining test system developed by the German company Interling in order to improve safety and payload. The system is type-approved and enables to increase of payload (up to 2% more 14t stability TEU) as it considers the real centers of gravity that are mostly lower than those prescribed by authorities for stability calculations.

Intermediate shafting – The lengths of shafting between the **propeller shaft** and the engine or the gearbox.

Intermediate bulk container (IBC) – A rigid, semi-rigid or flexible, portable bulk container packaging of a capacity of not more than 3m³, designed for mechanical handling and tested for its satisfactory resistance to handling and transport stresses.

Intermittent weld – A weld in which the continuity is broken by recurring unwelded spaces.

Intermodal transport, also multimodal transport – Carriage of goods employing various modes of transport, i.e. sea/land, rail/sea, etc., between the sender and the receiver.

INTERMODESHIP – The intermodal project for river-sea-river trailer transport which aims to develop **ro-ro** vessels to sail on various shortsea routes and which would also be capable of navigating up important inland waterways. Various routes have been identified as suitable, including Paris (France) to Southampton or Portsmouth (England), UK East Coast to Duisburg (Germany), and Lake Vanern (Sweden) to Duisburg. A prototype study has centred on the difficult Lake Vanern route, where hull dimensions are limited to 88.00m length and 13.40m breadth by the Trollhattan lock flight. Into such a hull, the design team is proposing to load 48 trailers. The access arrangement for three cargo levels have been developed by TTS; this will use straight-line kerbs and trestles, both developed under the EU sponsored **IPSI** and **INTEGRATION** projects. Access gear includes a novel folding stern ramp that can be hoisted to connect with part of the upper deck that can be lowered to provide access to that level, also an enterprising box-shaped hoistable ramp to the lower hold. Trucks can be stowed there to maximize loading, while the top of the “box” forms the main-deck ramp cover. Although trailers are the primary envisaged cargo, cassettes and swap-bodies could be loaded in future, using the automatically-guided vehicles (AGVs).

Internal combustion engine – In an internal combustion engine the energy supplied by a burning fuel is directly converted into mechanical energy by the controlled burning of the fuel in an enclosed space. The explosive fuel-air mixture may be ignited either by an electric spark or by the resulting compression temperature. In reciprocating engines the explosion causes the rotation of some engine parts by driving the piston in the cylinder. The motion is transmitted to the crankshaft by means of the connecting rod.

We can classify internal combustion reciprocating engines according to the number of strokes of the piston in one complete working cycle. Thus, we can speak of two-stroke engines and four-stroke engines.

The complete cycle of events of the former group, that is suction, compression, explosion and exhaust, is accomplished in a single revolution of the crankshaft or in two strokes of the piston, as the compression and expansion of the charge take place during one stroke, while the admission of a fresh charge occurs during the other stroke simultaneously with the escape of the burnt gases. In four-stroke engines the complete engine cycle is accomplished within two revolutions of the crankshaft or four strokes of piston.

There is still another classification according to the process of combustion: explosion or constant-volume combustion engines and constant-pressure combustion or **Diesel engines**.

Spark-ignition engine – Internal combustion engine typically running on gasoline or natural gas, where the combustion process is initiated by a spark plug.

Internal watertight integrity – The capability of internal structures and their closing appliances to prevent **progressive flooding** to volumes assumed buoyant or intact.

International Association of Classification Societies (IACS) – IACS was formed in 1968 to promote the highest standard in safety and pollution prevention.

Address: The Permanent Secretary, International Association of Classification Societies, 5 Old Queen Street, London, SW1H 9JA,

Homepage: www.iacs.org.uk **email:** permsec@iacs.org.uk

IACS is introducing a series of manuals with the intention of giving guidelines to assist the surveyors involved in the survey, assessment and repair of hull structures for general cargo ships, bulk carriers and tankers.

International Association of Dry Cargo Shipowners (INTERCARGO) – INTERCARGO represents the interests of owners, operators and managers of dry cargo shipping.

Homepage: www.intercargoo.org

International Bulk Chemical Code (IBC Code) – The International Code for the Construction and Equipment of Ships Carrying Dangerous Chemicals in Bulk. The IBC Code contains the **IMO** regulations that govern the design, construction, and outfitting of new built or converted chemical tankers. The IBC Code replaced the Code for the Construction and Equipment of Ships Carrying Dangerous Chemical in Bulk, which applies to chemical tankers built or converted before 1 July 1986.

International Chamber of Shipping (ICS) – The International Chamber of Shipping is the international trade association for merchant ship operators. ICS represents the collective views of the international industry from different nations, sectors and trades. ICS membership comprises national shipowners' associations representing over half of the world merchant fleet. **Homepage:** www.marisec.org

International Code on Intact Stability, 2008 (2008 IS Code) – The revised and renamed Intact Stability Code (IS Code). The 2008 IS Code consists of two different parts: Part A which include the mandatory stability criteria; and Part B which provides guidance and recommendations. It is due to come into force for ships constructed on or after 1st July 2010.

This Code prescribes general intact stability criteria for different types of ships and special criteria for certain types of ships (*passenger ships, oil tankers of 5000tdw and above, cargo ships carrying timber deck cargoes, cargo ships carrying grain in bulk and High Speed Crafts*).

The 2008 IS Code also describes recommended design criteria for certain types of ships (*fishing vessels, pontoons, container ships greater than 100m, offshore supply vessels, special purpose vessels and mobile offshore drilling units*).

International Convention for Safety of Life at Sea – see **SOLAS 1974**.

International Convention for the Control and Management of Ship's Ballast Water and Sediments (BWM Convention) – All around the world more than 10 billion tons of ballast water are carried in ships each year, containing thousands of species of aquatic animals and plants, creating problems for the marine environment and human health, threatening the aquatic flora and economies that depend on healthy aquatic ecosystems. In February 2004 the IMO has adopted the International Convention for the Control and

Management of Ship's Ballast Water and Sediments, which is expected to enter into force in early 2012.

Since the adoption of the Convention, IMO has developed a series of guidelines that further clarify the requirements of the Convention. Detailed list can be found in the ABS notice "Ballast Water Treatment Advisory".

The purpose of the Convention is to regulate discharges of ballast water and to reduce the risk of introducing non-native species that could harm sensitive ecosystems. In order to show compliance with the requirements of the Convention each vessel shall have on board a valid certificate, a **Ballast Water Management Plan** and a Ballast Water Record Book. Until the **ballast water performance standard D2** becomes compulsory, ship owners are not required, yet encouraged, to install a **Ballast Water Treatment System** onboard their vessels. As an interim means, referred to as **ballast water exchange standard D1**, ships have to exchange their ballast water at sea.

International Convention for the Prevention of Pollution from Ships – see MARPOL 73/78.

International Convention on Load Lines 1966 (ICLL 1966) – ICLL 1966 and its Protocol of 1988 are a comprehensive set of regulations to determine the minimum allowable

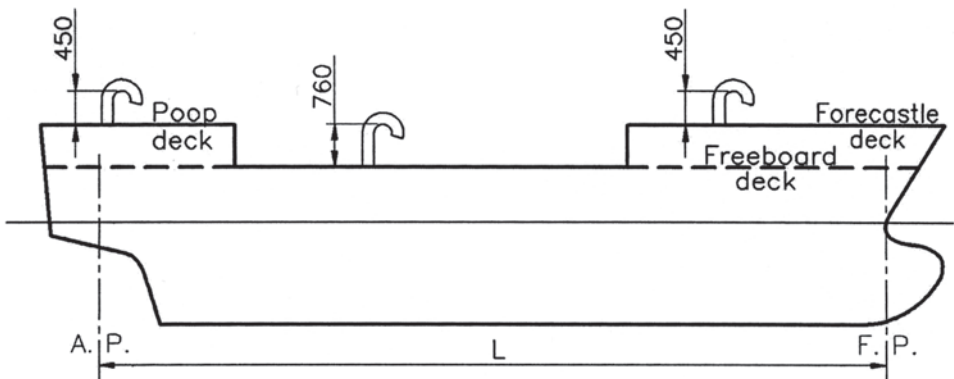

International Convention on Load Lines; Air pipes

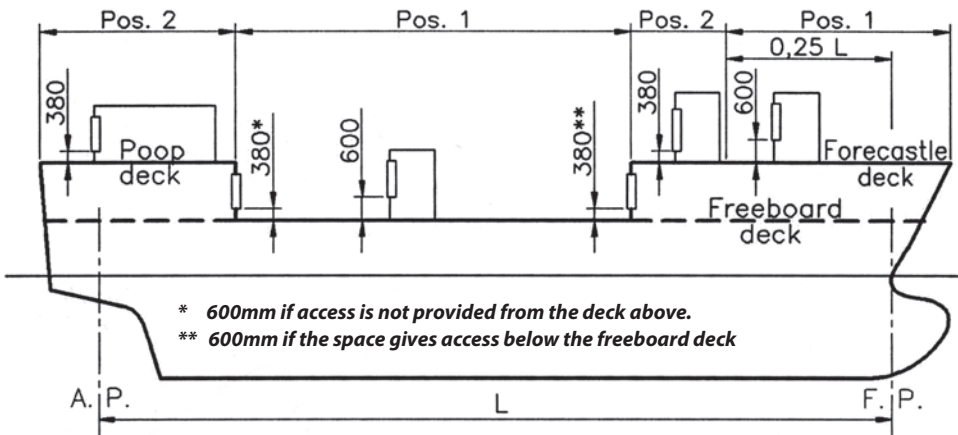

International Convention on Load Lines; Door sills

freeboard and defines conditions of load line assignment. The minimum geometric summer freeboard is computed by taking a freeboard for a standard ship of the same length (provided in tabular form) and correcting it for those geometric properties of the ship which differ from those of the standard ship. There are corrections for block coefficient, depth, superstructure, trunks and sheer. The result of this calculation, the Freeboard mark, is permanently marked on the ship hull.

The assignment of the computed freeboard is conditional upon the prescribed means of protection and closure of openings such as hatchways, doorways, ventilation, air pipes, scuppers and discharges being complied with. Regulations are also included for freeing ports in bulwark to prevent water accumulating on deck, and for guard rails and walkways to provide safe passage.

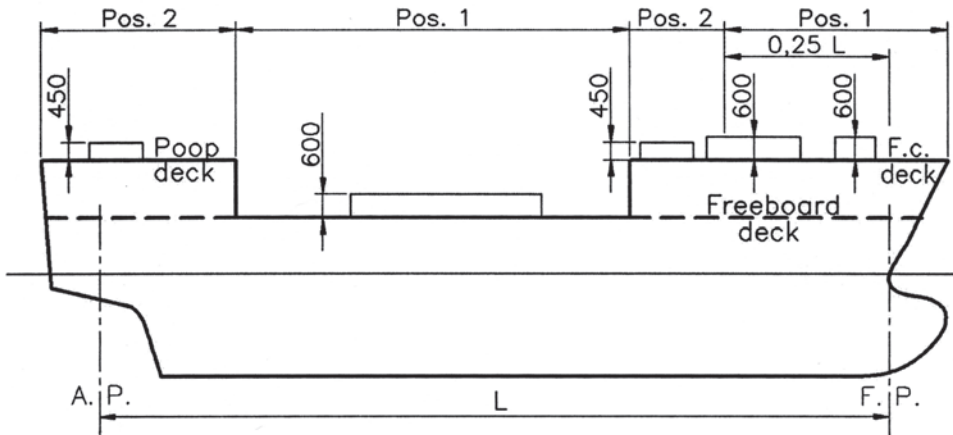

International Convention on Load Lines; Required coaming heights (mm) of hatches

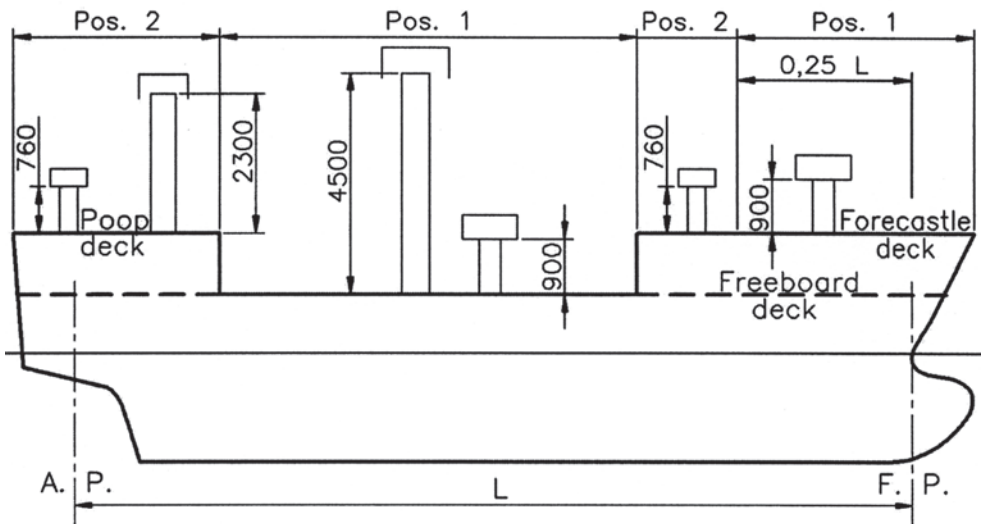

International Convention on Load Lines; Required ventilator coaming heights (mm)

International Convention on Load Lines; Positions – For the purpose of the Convention, two positions of hatchways, doorways and ventilators are defined:

Position 1 – Upon exposed freeboard and raised quarter decks, and upon exposed superstructure decks situated forward of a point located a quarter of the ship's length from the **forward perpendicular**.

Position 2 – Upon exposed superstructure decks situated abaft a quarter of the ship's length from the forward perpendicular and located at least one standard height of superstructure above the freeboard deck or upon exposed superstructure decks situated forward of point located a quarter of the ship's length from the forward perpendicular and located at least two standard heights of superstructure above the freeboard deck.

International Convention on Standards of Training, Certification and Watchkeeping for Seafarers (STCW 78/95) – STCW 78/95 defines the standards for the training and qualification for deck and machinery department and radio communication. It applies to the seafarers servicing onboard of seagoing ships except of warships, fishing vessels, pleasure yachts and wooden ships of simple construction.

International Convention on Tonnage Measurement of Ships 1969 (TONNAGE 1969) – This Convention governs the measurement of ship's size in accordance with enclosed cubic capacity. The size of a ship is then quoted as a gross tonnage. The net tonnage is a measurement applicable to the ship freight capacity.

International Gas Carrier Code (IGC Code) – The International Code for Construction and Equipment of Ships Carrying Liquefied Gases in Bulk adopted by **IMO** by resolution MSC.5(48). This Code applies to ships built after 1.07.1998, regardless of their size, including those of less than 500 tons gross tonnage, engaged in the carriage of liquefied gases having a vapour pressure exceeding 2.8 bar absolute at a temperature of 37.8°C, and other products covered by this Code, when carried in bulk.

International Grain Code – The International Code for the Safe Carriage of Grain in Bulk.

International Institute of Marine Surveyors (IIMS) – The institute founded in London in 1991. Associates are entitled to use the letters Assoc. IIMS after their names and full members can style themselves MIIMS.

Address: Honorary Secretary c/o HQS Wellington, Temple Stairs, Victoria Embankment, LONDON WC2R 2PN.

International Labour Organization (ILO) – One of the oldest components of the UN system of specialized agencies involved over the years in appraising and seeking to improve and regulate conditions for seafarers. In its unusual tripartite way, involving official representatives of government, employer and employee interests, its joint Maritime Commission have had in hand moves on the employment of foreign seafarers to urge the application of minimum labour standards, on crew accommodation, accident prevention, medical examination and medical care, food and catering and officers competency.

Homepage: www.ilo.org

International Life-Saving Appliance Code (LSA Code) – This code provides international standards for the **life-saving appliances** required by the SOLAS Convention.

International Marine Contractors Association – IMCA is the international trade association representing offshore, marine and underwater engineering companies. It was formed in April 1995 from the amalgamation of AODC (originally the International Association of Offshore Diving Contractors), founded in

POSITIONS

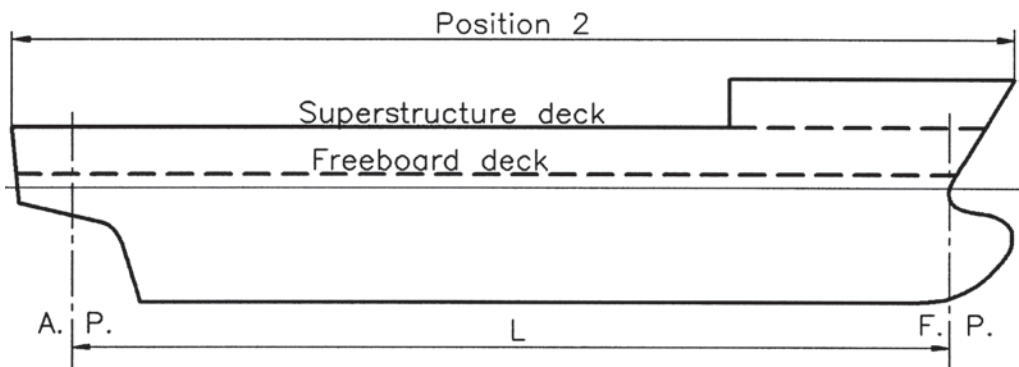
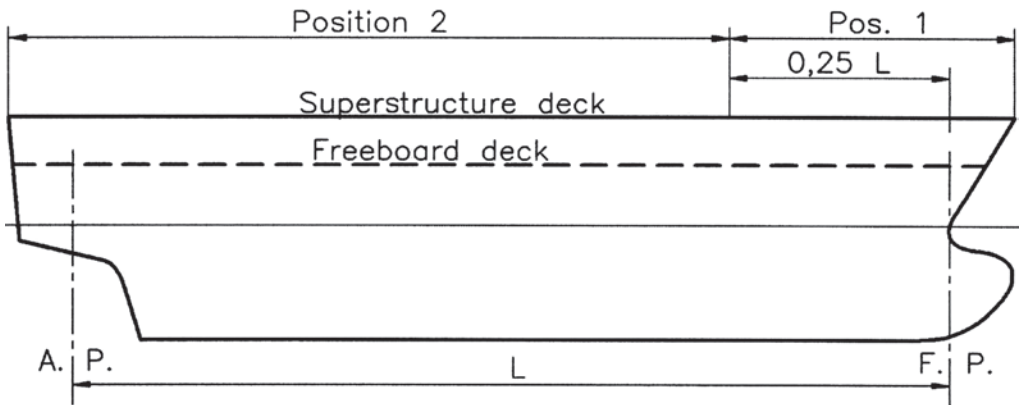
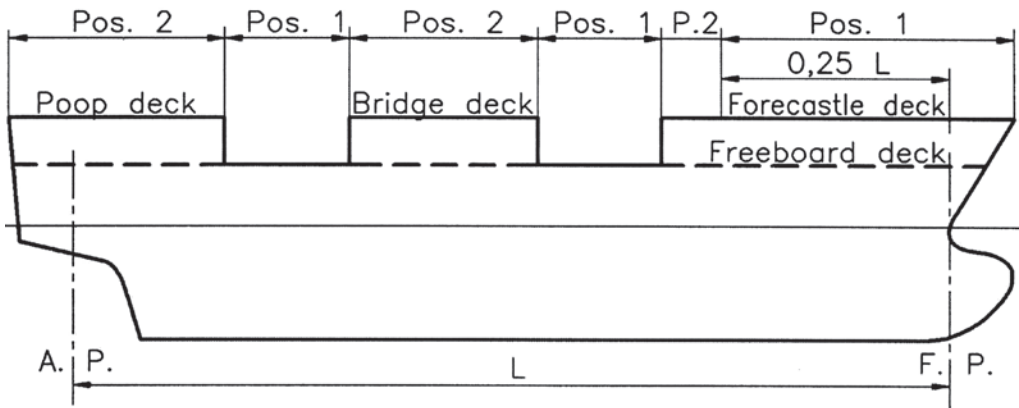

1972, and DPVOA (the Dynamic Positioning Vessel Owners Association), founded in 1990.

IMCA promotes improvements in quality, health, safety, and environmental and technical standards through the publication of guidance and information notes, codes of practice, and by other appropriate means. Members also receive regular briefing notes on technical issues, regulatory developments, and news and events appropriate to their areas of activity. **Homepage:** www.imca-int.com

International Maritime Dangerous Goods Code (IMDG Code) – Transport of **dangerous goods** by sea is regulated by IMDG Code in order to prevent injury to persons or damage to ships and their cargoes. Transport of marine pollutants is primarily regulated to prevent harm to the marine environment. The objective of the IMDG Code is to enhance the safe transport of dangerous goods while facilitating the free unrestricted movement of such goods.

The IMDG Code contains details of all the numerous dangerous cargoes offered for carriage by sea and includes solid, liquid and gaseous substances. Explosive, flammable, oxidising and radioactive substances are also included and recommended means of their containment or packing are listed, as is all manner of other information relating to the product. Future updating of the Code, on two-year basis, are foreseen in order to take into account technological developments.

International Maritime Organization (IMO) – The agency of the United Nations which is responsible for measures to improve the safety of international shipping and to prevent marine pollution from ships. It also is involved in legal matters, including liability and compensation issues and the facilitation of international maritime traffic. It was established by a Convention adopted under the auspices of the United Nations in Geneva on 17 March 1948 and met for the first time in January 1959. It currently has 167 Member States and 3 Associate Members. IMO governing body is the Assembly which is made up of all 167 Member States and meets normally once every two years. It adopts the budget for the next biennium together with technical resolutions and recommendations prepared by subsidiary bodies during the previous two years. The Council acts as governing body in between Assembly sessions. It prepares the budget and work program for the Assembly. The main technical work is carried out by the Maritime Safety, Marine Environment Protection, Legal, Technical Co-operation and Facilitation Committees and a number of sub-committees.

Homepage: www.imo.org

International NAVTEX service – The co-coordinated broadcast and automatic reception on 518 kHz of **maritime safety information** by means of narrow-band **direct-printing telegraphy** using the English language.

International Oil Pollution Compensation Fund – An intergovernmental agency designed to pay compensation for oil pollution damage, exceeding the shipowner liability. It was created by IMO Convention in 1971 and started its operations in October 1978. Contributions come mainly from the oil companies and member states.

International Oil Pollution Prevention Certificate (IOPP Certificate) – The IOPP certificate is issued to each new ship after an appointed surveyor has inspected it and found it to be in compliance with the **MARPOL** convention. The IOPP certificate gives details of all oily water separation and filtering equipment and also the associated monitoring equipment required under the convention.

International Safety Management Code, (ISM Code) – The International Management Code for the Safe Operation of Ships and for Pollution Prevention adopted by **IMO** as a new chapter to **SOLAS** convention. The ISM code applies to arrangements adopted by a shipping company to control safety and to prevent the risk of pollution.

International Ship and Port Security Code (ISPS Code) – The new security regime for international shipping entered into force in July 2004. The Code takes the approach that ensuring the security of ships and port facilities is basically a risk management activity and that to determine what security measures are appropriate, an assessment of the risk must be made in each particular case.

The risk management concept is embodied in the Code through a number of minimum functional security requirements for ships and port facilities. For ships, these requirements include: ship security plan, ship security officers, company security officers, and certain on-board equipment.

In order to announce the threat at a port facility or for a ship, the Contracting Government will set the appropriate security level. Security levels 1, 2, and 3 correspond to normal, medium and high threat situations respectively.

International Ship Suppliers Association (ISSA) – ISSA was formed in 1955 and is now representing nearly 2,000 ship suppliers throughout the world. The ISSA Ship Stores Catalogue is available in printed form, on-line or on CD-ROM.

Address: ISSA, The Baltic Exchange, St Mary Axe, London, EC3A 8BH, UK, issa@dial.pipex.com , www.shipsupply.org

International Shipping Federation (ISF) – The ISF is the international federation for employees of the shipping industry.

Homepage: www.marisec.org email: isf@marisec.org

International shore connection – A standard-sized **flange**, together with nuts, bolts and washers, which has a coupling suitable for the ship hoses. It is used to connect the shore water main in any port to ship fire main and equipment.

A shore connection with a standard coupling or other facilities should be provided for transferring contaminated liquids to onshore reception facilities.

International Towing Tank Conference (ITTC) – A voluntary association of worldwide organizations that have responsibility for the prediction of hydrodynamic performance of ships and marine installations based on the results of physical and numerical modeling. The primary task of the International Towing Tank Conference is to stimulate progress in solving the technical problems that are of importance to towing tank Directors and Superintendents who are responsible for giving advice and information regarding full-scale performance to designers, builders and operators of ships and marine installations based on the results of physical and numerical modeling. The Conference also aims at stimulating research in all fields in which a better knowledge of the hydrodynamics of ships and marine installations is needed to improve methods of model experiments, numerical modeling and full-scale measurements; at recommending procedures for general use in carrying out physical model experiments and numerical modeling of ships and marine installations; in validating the accuracy of such full-scale predictions and measurements for quality assurance; at formulating collective policy on matters of common interest; and at providing an effective organisation for the interchange of information on such matters.

ITTC Recommended Procedures – The ITTC Recommended Procedures give the ITTC Community's current technical opinion and recommendations on the way to conduct

physical and numerical testing including analyses and other associated matters. There is a continuous process to update and improve the Procedures as well as developing new Procedures.

Note: *All Procedures can be found by opening the document Procedures Register, from which direct links are set to each Procedure: visit <http://ittc.sname.org>*

INTERTANKO – International Association of Independent Tankers Owners.

Intrinsically safe – An electrical circuit or part of a circuit is intrinsically safe if any spark or thermal effect produced normally (i.e., by breaking or closing the circuit) or accidentally (e.g. by short circuit or earth fault) is incapable, under prescribed test conditions, of igniting a prescribed gas mixture.

Invar – A special material (36% nickel steel) having extremely small coefficient of thermal expansion. Invar is used as the primary and secondary barrier for the Gas Transport **LNG containment systems**.

Inverter – A static device (circuit) which converts electrical power in the form of direct current (DC) to electrical power in the form of alternating current (AC). Inverters are used to supply electric power to, and to control the speed of, both asynchronous induction motors and synchronous AC motors.

Iron – This metal is gray, malleable and ductile and has exceptional magnetic properties. It readily oxidizes in moist air and is attacked by many corrosive agents. It rarely appears as pure metal. It is nearly always found as **iron ore** which is a compound of iron and oxygen, or of iron, oxygen and carbon joined with other substances such as limestone and clay.

Iron ore – Iron ore stows at 0.4-0.5m³/t and is thus one of the densest materials carried in ships.

IRONSAILOR – An automatic mooring device developed in New Zealand by Mooring International for the **rail/vehicle ferry ARATERE**.

Two such devices are fitted on the port side of the ferry fore and aft. Each of them consists of a hydraulically-operated, extendible arm, at the end of which there are two vacuum pads in the form of steel rectangles (1.2m x 1m) surrounded by rubber vacuum holding frames. Operated from the ship bridge, with the aid of television cameras which give a clear view along the ship sides and astern, the units are guided towards steel plates fixed to the quayside. On the contact, a vacuum is created in each suction pad which holds the vessel in place. The units are fitted approximately 2m above the waterline and are designed to resist a pull of 12.5t each.

Itinerary – List of ports of call of a ship.

ITTC Performance Prediction Method – The 1978 ITTC PERFORMANCE Prediction Method is the method developed to predict the rate of propeller revolutions and delivered power of a single screw ship from the **model test** results. The viscous and the residuary resistance of the ship are calculated from the model resistance tests assuming the form factor to be independent of scale and speed. The ITTC standard predictions of rate revolutions and delivered power are obtained from full-scale propeller characteristics determined by correcting the model values for drag scale effects. The original 1978 method was modified in 1984 and 1987 for a better and more convenient use of the program.

Further reading: *ITTC – Recommended Procedure 7.5-02-03-01.4.*

Jack – A device which can lift weights or exert a large thrust in order to move or position some equipment. It is usually hydraulically operated.

Jacket –

1. The passageways which surround the engine cylinders.
2. Steel support framework used to support offshore platform topsides.

Jacket cooling water system – The jacket cooling water system is used for cooling the cylinder liners, cylinder covers and exhaust valves of the main engine.

Jack-up drill rigs, also self-elevating drilling platforms – see **MOBILE OFFSHORE DRILLING UNITS**.



Jalousie – A shutter or cover with louvers. It provides ventilation while restricting the entry of rain and wind.

Jettison of cargo – Act of throwing cargo or equipment (jetsam) overboard in order to lighten the vessel or improve its stability in case of emergency.

Jetty, pier – A structure that projects into the water to a reasonable depth of water. It enables ships or boats to come alongside to load or discharge cargo or passengers.

Joiner arrangement – There are construction details showing the combination of all structural fire protection materials. For example, a detail showing the connection of the ceilings to decks, ceilings to bulkheads, bulkheads to bulkheads, bulkhead construction details, etc.

Joule-Thomson effect – When a fluid is allowed to expand without generating external work and no external heat transfer take place, a temperature change results. Normally the temperature drops after expansion but for some cases a temperature increase may result (e.g. Hydrogen and Helium).

KAPPEL propeller – A new screw propeller with higher efficiency than a conventional state-of-the-art propeller. Whereas traditional ship propellers have blades modeled on the basis of helical surfaces, the KAPPEL propeller has modified blade tips smoothly curved to the suction side of the blade. A first full-scale KAPPEL propeller was manufactured for the 35,000dwt product carrier MT NORDAMERIKA. It was tested at sea immediately after tests with the conventional propeller originally designed for the ship. The results confirmed the model test predictions that the improvement in efficiency of 4% aimed at was achieved. Furthermore, the pressure pulse level was slightly lower with the KAPPEL propeller than with the state-of-the-art comparator propeller.

Keel – The principal fore-and-aft component of ship framing, located along the centreline of the bottom and connected to the stem and stern frames. Floors or bottom transverses are attached to the keel.

Duct keel – A hollow passage within the double bottom along the centreline of the vessel used for piping.

Keel blocks – Heavy wooden or concrete blocks on which ship rests during construction or repair.

Kelly – A long hollow, square section forging which screws into the top section of a **drill pipe**. It is driven by the **rotary table** and provides the drill pipe with both rotational movement and **drilling mud**.

Key – A machined metal bar which is used to connect a component to a shaft.

Keyless fitting of fixed pitch propeller – Keyless bore propellers are press fitted on the shaft cone. Oil is injected under pressure between the bore and the shaft by means of pumps feeding a system of grooves in the propeller bore. The grooves facilitate the spread of oil between the surface and the coefficient of friction is in this way temporarily reduced to less than 0.02. It is then quite easy, using a hydraulic device, to push the propeller against the taper into sufficient degree of interference. The propeller is pushed up a precalculated distance. The temperature is included as a variable due to the fact that the shaft and propeller are made of different materials.

Keyway – The groove or slot in which a key fits. It must be carefully designed to avoid weakening of the shaft or creating an area of stress concentration.

Kinematic viscosity – The absolute viscosity of a fluid divided by its density at the temperature of viscosity measurement.

Kingston valve – A conical valve, opening outward, to close the mouth of a pipe which passes through the side of a vessel below the water line. The valve connects ship's tanks to the sea and, when open, allows sea water to enter the tank for the purpose of cleaning, or to admit water ballast on submarines when the submarine dives.

Knocking – Knocking in spark-ignition engines occurs when the fuel-air mixture spontaneously and violently ignites ahead of the normal flame front.

Knot – A unit of speed, equal to one nautical mile (6,076 feet or 1852 meters) per hour. In the days of sail, speed was measured by tossing overboard a log which was secured by a line. Knots were tied into the line at intervals of approximately six feet. The number of knots measured was then compared to the time required to travel the distance of 1000 knots in the line.

Knuckle – An abrupt change in direction of plating, frames, keel, deck, or other structure of a ship.

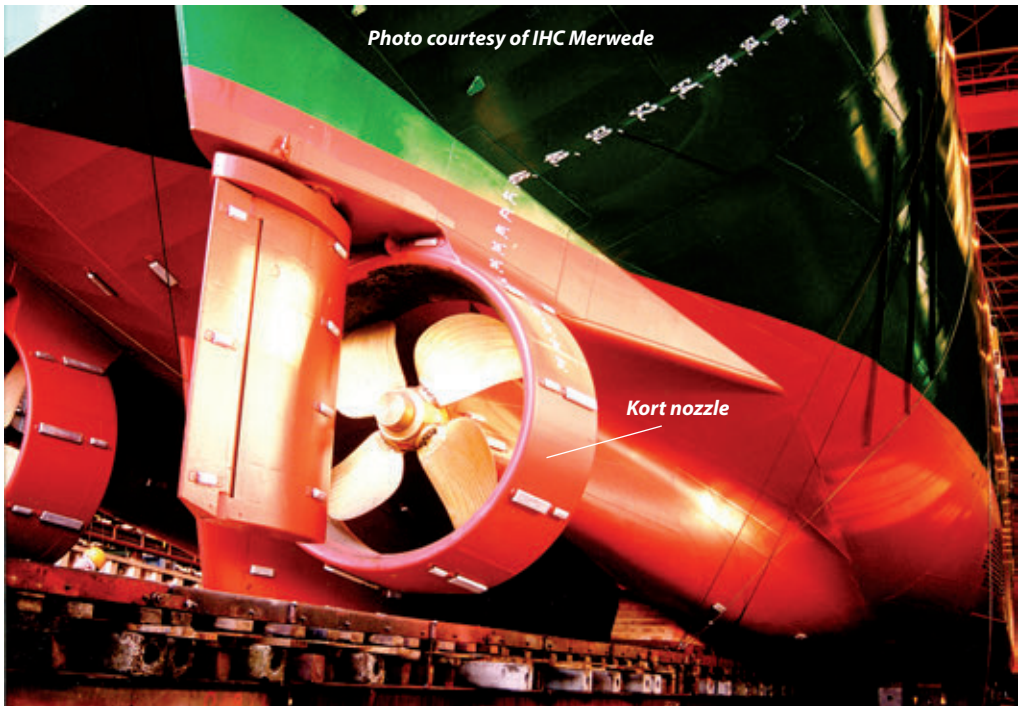

Kort nozzle – A fixed, annular forward extending duct around the propeller. The propeller operates with a small gap between blade tips and the nozzle internal wall, roughly at the narrowest point. The nozzle ring has a cross-section shaped as a hydrofoil.

KOTUG Rotor Tug

Developed and patented by Ton Kooren, the president of Dutch Towage Company KOTUG, the Rotor Tug represents a new concept in **tug** design. At its heart, there is a unique propulsion system utilizing three main engines, each driving a fully-azimuthing **rudder propeller**. Two of these **thrusters** are positioned forward of the **midship** section frame and one aft replacing the traditional **skeg**. This arrangement offers a number of significant advantages; the tug has the ability to turn rapidly in its own length, and apply almost all of its **bollard pull** in any direction. The lack of a substantial skeg reduces resistance to turning and cuts down the influence of a ship propeller wash when working in close proximity to large vessels underway.

In 1999, KOTUG introduced four Rotor tugs: RT MAGIC, RT INNOVATION, RT PIONEER and RT SPIRIT to Rotterdam and Bremerhaven in order to extend their market share. Each tug is 31.61m of length overall, with a beam (moulded) of 12.00m, and a working draft of 5.90m. A single chine hull configuration was chosen for the heavily-built steel hull. A semi-raised **forecastle** gives some protection when the vessel operates at sea and in the escort role. No underwater skeg is fitted but some protection is provided to the **propellers** and for docking purposes by guard plates and struts. Three very small fins located under the **stern** enhance directional stability.

Three main engines are installed, each with a maximum continuous rating (MCR) of 2100 brake horsepower running at 1600 rev/min. Each engine drives an SRP 1212 FP propulsion

KOTUG Rotor Tug

Sketch courtesy of Schottel GmbH

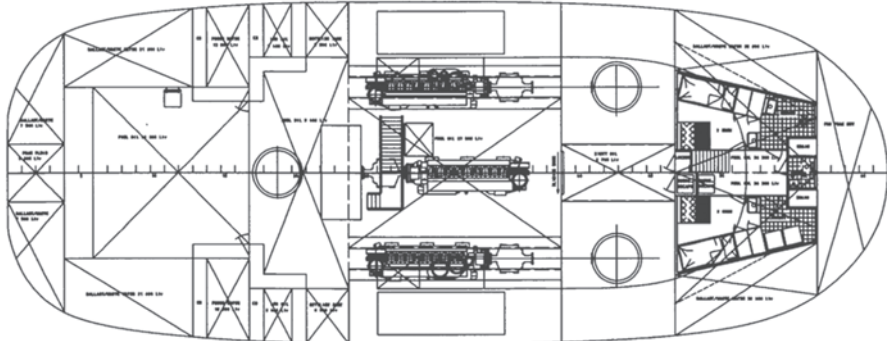
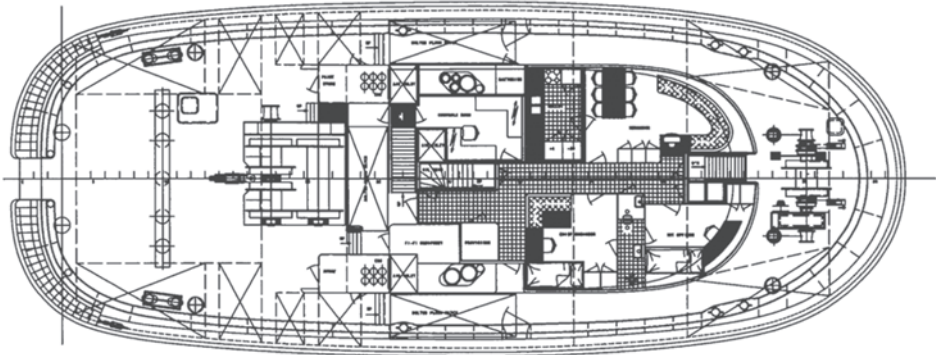
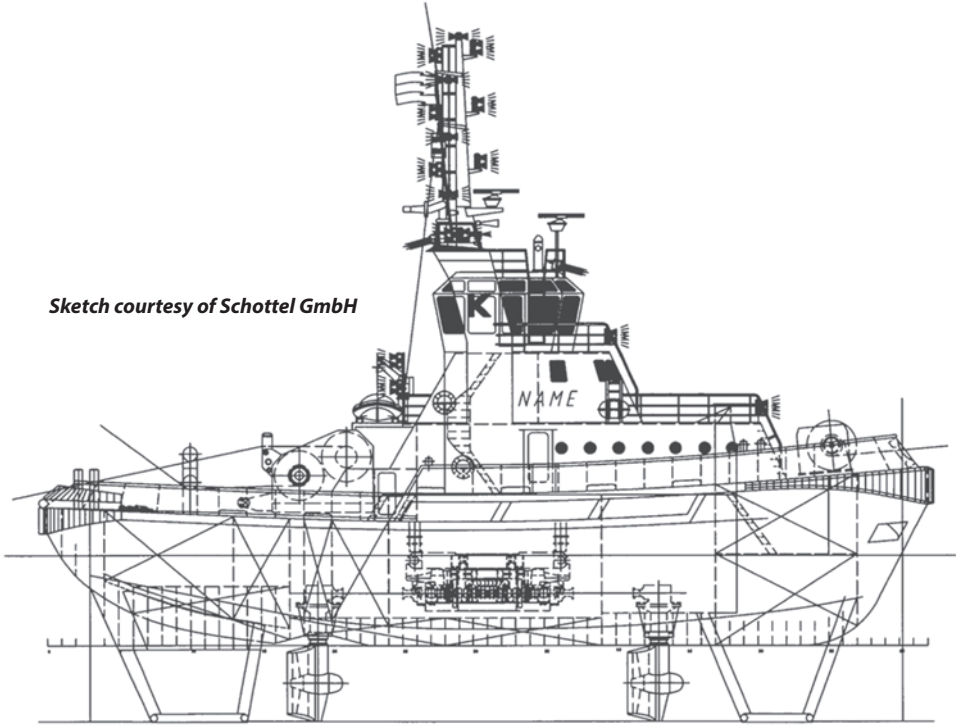

unit, incorporating a five-blade fixed pitch propeller of 2.15m diameter and a **Kort nozzle**. Power is transmitted through Twin Disc type 3000-2LD Marine Control Drive (MCD) units. The main engines are sited "side by side" across the engine room, with the outboard engines coupled to the forward Schottel units and the center engine driving the aft unit. On trials the tugs produced a bollard pull ahead of 75 tonnes and 73.5 tonnes astern, with a free-running speed of 12 knots.

Each propulsion unit has its own manual controller, giving the tugmaster individual control of thrust direction and propeller speed. A fourth "Masterpilot" controller enables any combination of units to be directed in unison.

Beside the propulsion units, the most impressive feature of these new tugs is the towing equipment and the deck layout. The main towing winch, located on the aft deck, is a "waterfall" type hydraulic winch with three declutchable drums incorporating stainless steel band brakes. Intended principally for towing at sea, the full width upper drum is capable of accommodating 650m of 56mm diameter steel wire rope, along with a 20m long nylon spring rope of 100mm in diameter. The lower drums are used for shiphandling and each carries 200m of 56mm steel wire rope, with 10m long nylon spring of 48mm in diameter steel wire pennant. Loading and changing towlines is speeded up by the provision of specially designed recessed end terminations, located in the side plates of each winch drum.

Crew **accommodation** is fitted out to a very high standard. The Rotor tugs will normally work with a **crew** of three, with additional manning for sea operations. Provision is made for a maximum of seven crewmembers, in three single and two twin-berth cabins.

Ladder – Steps used aboard ship in place of stairs. The angle of inclination for a vertical ladder should be between 75–90 degrees. Continuous ladders should not exceed 9.1m (30 ft) in height.

Further reading: *ABS Guidance Notes for the “Application of Ergonomics to Marine Systems”*; *ABS Guide for “Means of Access to Tanks and Holds for Inspection”* – can be downloaded from www.eagle.org

Lagging – An insulating material applied to surfaces of pipes, or the boiler casing in order to reduce heat transfer.

Laid-up tonnage – Ships not in active service; a ship which is out of commission for fitting out, awaiting better markets, needing work for **classification**, etc.

Laker – A type of ship which trades only in the Great Lakes of North America. They usually carry **grain** and ore cargoes.

Laminar flow – A fluid flow in which the adjacent layers do not mix.

Lamination – An excessively large, laminar, non-metallic inclusion, producing a defect appearing in sheets or strips as segregation or in layers. Severe lamination can be repaired by a local insert plate.

Landmarks – Prominent objects on land (churches, towers, high buildings, etc.), beacons and lighthouses serving as guides to steer by, when approaching an estuary, river or harbour.

Lap joint – A joint between two overlapping members in parallel plane.

LASH (Lighter aboard ship) – A barge carrier designed to act as a shuttle between ports, taking and discharging barges (lighters). The ship is provided with massive crane which loads and discharges the lighters over the stern. The lighters each have the capacity of 400 tons and are stowed in the holds and on deck. When the ship is at sea with one set of lighters, further sets can be made ready. Loading and discharge is rapid at about 15 minutes per lighter, no port or dock facilities are needed and the lighters can be grouped for pushing by tugs along inland waterways.

Lashing – Wires, chains, ropes, or straps used to secure cargo on a ship. See also **container lashing equipment**.

Trailer lashing system Autotrestle on “TOR SELANDIA”

The Autotrestle securing unit incorporates a recessed and built-in fifth wheel which couples directly to the trailer kingpin. The terminal tractor connects with the trestle and trailer combination on land and drives the whole unit aboard the vessel where the trestle bridge is positioned over the point of stow. Twistlocks at the base of the trestle legs, controlled from the dock tractor, are automatically clamped to flush sockets in the deck. The connection and heavily-reinforced socket are designed to absorb vertical, longitudinal and transverse forces that may be experienced in a seaway in the most adverse weather conditions, with additional security gained by the use of two web lashings applied to the rear of the trailer.

Lashing bridge – A strong steel structure installed between hatches to permit the stowage of an additional tier of containers or heavier containers in the upper tier. Lashings can be applied at a higher level but can also remain short.

LASHING BRIDGES



Lashing bridges on an ultra large container vessel

Photo: J. Babicz



Lashing bridge on CV 5300 TEU

Latent heat

Latent heat – The heat energy required to bring about a change of state of a unit mass of a substance, without any change in temperature, e.g. from solid to a liquid.

Latex – A resin used in **emulsion paints**.

Launch – A motorboat intended for operation in ports, bays and on calm water, limited to a wind force not exceeding 4 Beaufort scale. Seagoing launches are units intended for seagoing service, limited to a wind force not exceeding 6 Beaufort scale.

Launch and recovery system of the underwater unit – The lifting equipment necessary for raising, lowering and transporting the underwater unit between the surface and the working site.

Launching – The transfer of a ship from land to water. The traditional launching is the sliding of a ship by its own weight into the water down inclined launch ways. If a vessel is built

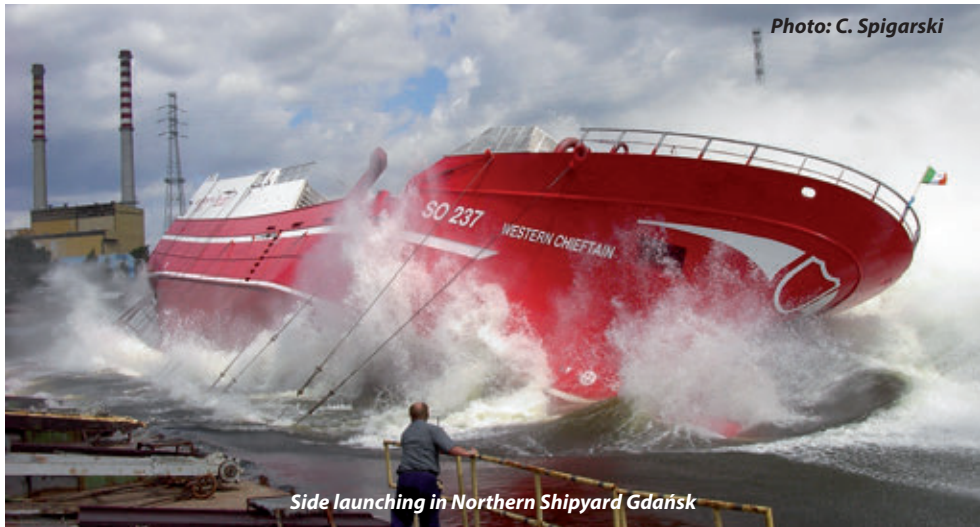

in a **dry dock**, floating off or **float out** is the equivalent of launching. **Ship elevator** and transfer system can be used to launch a vessel.

Photo courtesy of Stocznia Szczecińska Nowa Sp. z o. o.



Photo: M. Kolesiński

End launching in Szczecin New Shipyard

The traditional launching of a vessel is a critical and potentially hazardous event in the building process if the movement of the large, yet fragile, mass that is supported on a comparatively frail structure, is not properly planned and carried out.



Photo: J. Babicz

Launching arrangement for free-fall lifeboat, rescue boat and 25-person liferaft

Launching appliance or arrangement – A means for transferring a **survival craft** or **rescue boat** from its stowed position safely to the water.

Launching ramp angle – The angle between the horizontal and the launch rail of the lifeboat in its launching position with the ship on even keel.

Launching ramp length – The distance between the stern of the lifeboat and the lower end of the launching ramp.

Layout – The arrangement of plant and equipment in, for example, a machinery space, or a drawing thereof.

Laytime – The time allowed by the shipowner to the voyage charterer or bill of lading holder for loading and/or discharging the cargo. It is expressed as a number of days or hours or as a number of tons per day.

Lay-up – Temporary cessation of trading of a ship by a shipowner during a period when there is a surplus of ships in relation to the level of available cargoes. This surplus, known as overtonnaging, has the effect of decreasing freight rates to the extent that some shipowners no longer find it economical to trade their ship, preferring to lay them up until there is a turnover in the trend.

Leading pair – The first pair of a folding hatch cover to fold and stow.

Leak –

1. A crack or hole through which liquid or gas escapes.
2. The passing of gas, water, etc. through a crack or hole.

All piping systems are to be leak tested under operational conditions, after completion on board.

Leaking – Escape of liquids such as water, oil, etc., out of pipes, boilers, tanks, etc., or a minor inflow of seawater into the vessel due to a damage to the hull.

Lean burn engine – Engine operating with excess air in the fuel-air mixture, resulting in the presence of relatively high oxygen concentration in the exhaust stream.

Length (L) of the ship – Depending on the purpose different definitions of length L are used:

1. (L) – 96% of the total length on a waterline at 85% of the least **moulded depth** measured from the top of the keel, or the length from the foreside of the stem to the axis of the **rudder stock** on that waterline, if that be greater, (**MARPOL, ICLL**).
2. According to **SOLAS** length of the ship is the length measured between perpendiculars taken at the extremities of the **deepest subdivision load line**.

Length on waterline – The length of a vessel measured along the **waterline** from forward to aft.

Length overall – The distance between the extreme points of a ship, forward and aft.

Level gauging system of the oil tanker UNITED GRACE

The UNITED GRACE is fitted with an automatic level **gauging** and tank monitoring system. The pressure sensors measure absolute pressures. The sensors are hermetically sealed without ventilation to the free atmosphere. Reference is made through an additional sensor, reading the atmospheric pressure on a continuous basis. Temperature measurement is integrated in the sensors for improvement of the pressure reading accuracy as well as temperature monitoring of the cargo. Together with the advanced signal handling and computer technology, the functions included are: – level gauging in cargo, slop, ballast and fuel oil tanks; – temperature measurement in cargo, slop and fuel oil tanks; – vapour (**inert gas**) pressure in cargo and slop tanks; – draught measurement; – loading computer for on/offline stability and stress with load planning; – print out of cargo transfer reports; – serial line interface for communication with other systems.

Lifeboat – A motor-propelled survival craft carried by a ship for use in emergency. A ship should be its own best lifeboat but there are sometimes situations where abandonment of the ship is unavoidable.

Lifeboats are manufactured from glass-reinforced polyester (GRP). Construction and equipment must comply with the LSA Code, number and arrangement with **SOLAS**. Various types of lifeboats are in use such as partially or fully enclosed crafts, fire protected lifeboats for tankers and free-fall lifeboats.

The conventional lifeboat is secured into gravity davits, which enable the boat to be launched over the ship's side without any mechanical assistance. Sometimes stored power davits are used.

People forced to use conventional lifeboats are exposed to the greatest risk during embarkation and recovery. An analysis of accidents involving lifeboats and davits reported by **IMO** shows that 60% were caused by lack of maintenance or improper resetting of hooks, release mechanism or winch and brakes assemblies. The most common cause of fatal accidents involving davit-launched lifeboats is the failure of **on-load release hooks**.



*It is very important to arrange a good access to the lifeboat.
Choose a davit which allow direct access without any boarding ladder*

In the 11 accidents reported over a 10-year period, seven people were killed and nine injured. These figures suggest that although there are still relatively few such failures, the consequences can be fatal.

Many of the ships lost have sunk very quickly in heavy weather, and the crew did not have enough time to launch lifeboats from davits. A more effective way of saving lives in the event of a ship sinking is to provide ships with **free-fall lifeboats**. The benefits are clear: during rapid evacuation in emergencies, the boat slides out from a ramp onboard the ship/installation and hits the water well away from the ship or installation with a high positive forward motion. Passengers are safe and secure in an enclosed cabin, securely strapped to anatomically shaped seats. The lifeboat system is robust and can withstand high winds, powerful waves and extreme weather conditions. See also **Survival Crafts and Rescue Boat Arrangement**.

Lifeboat davits – Lifeboat davits are to be capable of turning out against an adverse heel of 20° and a trim of 10°, with the boat having been fully boarded in the stowed position; or, in the case of oil tankers, chemical tankers and liquefied gas carriers, and adverse list greater than 20°, if found necessary on completion of damage stability calculations.

LIFEBOAT DAVITS

Photo: C. Spigarski



Single pivot gravity davits

Illustration courtesy of NOREQ

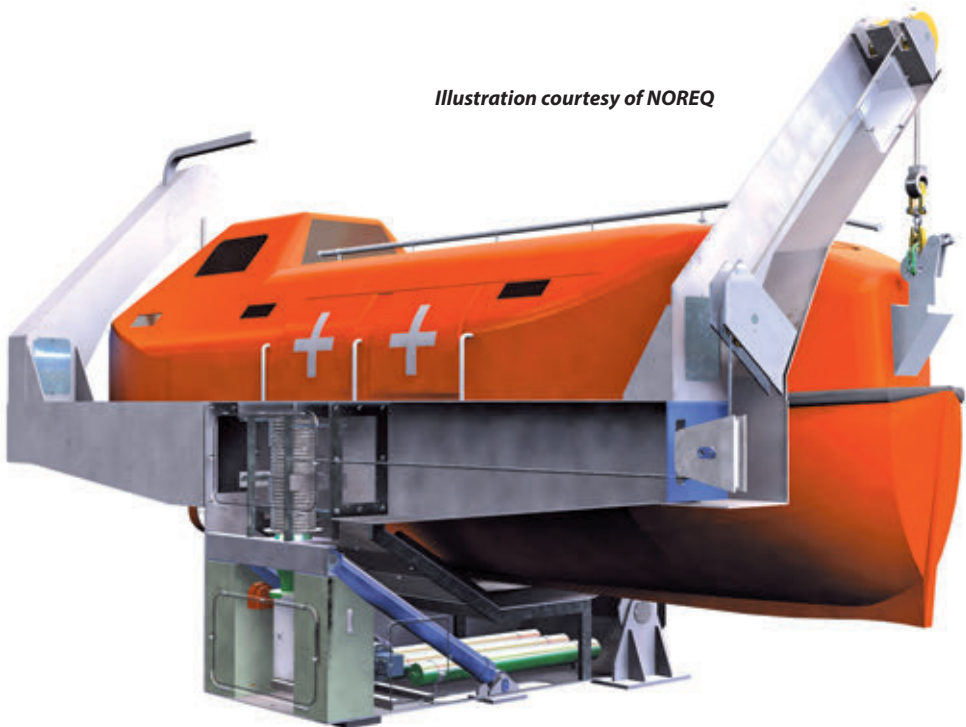

NOREQ compact davit with all functional components integrated inside the davit structure

Lifeboat station – A place assigned to crew and passengers where they have to meet before they will be ordered to enter the lifeboats.

Lifebuoy – A ring-shaped floating life preserver. Lifebuoys are required, primarily to assist in „man-overboard“ situations.

According to **SOLAS** the minimum number of lifebuoys on board ships depends on length of a ship in meters. Lifebuoys shall be stowed on both sides, on all open decks extending to the ship's side, and not permanently secured in any way.

At least one lifebuoy on each side of the ship must be fitted with a buoyant lifeline.

Not less than on half of the total number of lifebuoys must be provided with self-igniting lights. Not less than two of these must also be provided with lifebuoy self-activating signals and be capable of quick release from the navigation bridge.

Lifejacket – Lifejackets are designed to provide full support for a person in water, even if that person is unable to help himself or herself and is heavily clothed. Lifejackets may be constructed from foam or other permanently buoyant material, or they may be inflatable or partially inflatable. In a free-fall lifeboat, only inflatable lifejackets are permitted.

The Spanish company, Articulos Nauticos Cappymar is introducing a new lifejacket combined with a radio beacon connected to a receiver installed at the bridge. The equipment is designed to aid the search and rescue of people who accidentally fall from a vessel. In the event of a man overboard the radio beacon will activate automatically upon immersion and will start transmitting a distress signal on the international search and rescue frequency.

A lifejacket must be provided for every person on board the ship. In addition, a sufficient number of lifejackets must be carried for persons on watch and for use at remotely located survival craft stations. The lifejackets carried for persons on watch should be stowed on the bridge, in the engine control room and at any other manned watch station. Each lifejacket must be fitted with a light.

Liferaft – A rigid or inflatable raft designed to hold people abandoning ship. Liferafts are required as a back-up to lifeboats and in some small ships are allowed in lieu of lifeboats. Davit-launched liferafts or throwover inflatable liferafts are in use. An inflatable liferaft is usually stowed on deck in cylindrical, glass-reinforced plastic container. All approved liferafts (except for liferaft at stem) must be equipped with an automatic release gear (**hydrostatic release unit**) that makes the raft release automatically under water if no time is left for manual release.

Davit-launched raft – The davit-launched liferaft is to be connected to the davit and then inflated at deck level, thus enabling the passengers to board the raft from deck. The raft is then launched to the water. A liferaft must be at least 9 meters forward off the propeller.

Reversible liferaft – Whichever way a raft lands in the sea, a canopy is still offered and the task of turning the raft over is abolished.

Self-righting liferaft – A liferaft which turns automatically from a capsized position to an upright position.

Zodiac International has developed the self-righting technique to comply with the updated ro-ro ferry liferaft regulations. It enables liferafts to turn automatically from a capsized position to an upright position on the surface of the water, regardless of whether they inflate in the

LIFERAFT



*Throw over board liferafts
on the ramp*



Vessel name and port name are to be painted on raft containers

Liferaft equipment

inverted position underwater or on the surface of water, or capsize for any reason proceeding inflation.

Throw over liferaft – The throw-overboard liferaft is released from the cradle and then thrown overboard, or slides automatically when released. When waterborne, the liferaft inflates on a hard pull of the painter line and then is ready for boarding.

Useful websites: www.VIKING-life.com ; www.liferaftsystems.com.au

Liferaft equipment – The equipment level within a liferaft is usually referred to as a “**SOLAS A pack**” or **SOLAS B pack**”. Passenger vessels engaged on short international voyages or domestic voyages, should have liferafts equipped to the level of SOLAS B pack. SOLAS A pack is the level of equipment required for passenger vessels on long international voyages and for all other vessels to which SOLAS applies on international or domestic voyages.

Liferaft painter system – A connection between the ship and the liferaft. The liferaft painter system shall be so arranged as to ensure that the liferaft when released is not dragged under by the sinking ship.

Life-saving system – The life-saving system on a ship is an extension of emergency escape routes. To develop a planned, rational life-saving system the basic phases of the problem must be examined, i.e., pre-abandonment, abandonment, survival, detection and retrieval.

Pre-abandonment concerns the training, maintenance, stowage, capacity, protection and provision for effective usage of life-saving equipment under operating conditions. Abandonment comprises all operations required for breaking out of stowage and the safe disengagement and clearing away of the life-saving equipment with full complement from the stricken ship.

Survival is the preservation of groups of persons and individual persons at sea until rescued.

Detection is the accurate determination of the location of survivors.

Retrieval is the safe and expedient transfer of survivors to a position of safety.

The combination of life-saving equipment carried on the ship must be such that collectively all of the needs in these five areas are met. Any single piece of equipment cannot be expected to answer all problems. The mission of the vessel will have an impact on the degree of importance of each of these phases.

Existing life-saving systems are based on “abandon ship” approach. When a ship suffers a fire, collision, grounding or any other potential disaster, focus of people on board quickly turns to survival crafts, and on how these or other life-saving appliances might be used to escape from the stricken vessel. However, evacuation by **lifeboat** or **liferaft** is, in any case, fraught with danger. There is little chance of successful evacuation during a severe storm or from a ship with a pronounced list.

A major impetus for considering alternatives to the “abandon ship” approach was the rise of the mega-cruise ship. Modern cruise liners have the capacity of carrying several thousand people on board and even though accidents involving such large passenger ships are rare, if a serious accident should occur, its consequences could be disastrous.

One of the answers to the challenge of safe evacuation of large passenger ships is, paradoxically, not abandoning ship at all: people could stay safely on board as the ship proceeds to a port or to a place of refuge. The idea is to design ships which would not need to be evacuated at sea. Such ships must incorporate safety levels beyond today's state of art in respect of resistance to capsizing, sinking and fire safety – see **Safe Return to Port**.

Life-saving appliances, life-saving equipment – **Lifeboats, liferafts**, personal life-saving appliances (lifebuoys, lifejackets, immersion suits, etc).

The ISLE OF INISHMORE is fitted with life-saving appliances in compliance with the statutory requirements for the maximum numbers of passengers and crew. Life-saving appliances include: four 150-person-, and two 73-person partially enclosed motor lifeboats, and four Marine Escape Systems. Each Marine Escape System has a capacity for 550 persons and consists of a large inflatable slide on the boat deck, and four 50-person liferafts stowed in containers on Deck 10. Life-saving appliances are completed by lifebuoys and lifejackets.

Lift-and-roll cover – A hatch cover which is lifted by hydraulic jacks, or wheel lifts, and then can roll freely to a desired position. See also **hatch covers**.

Lift-away cover – A hatch cover lifted bodily off the coaming by a ship or shore crane to provide access to the hold. See also **hatch covers**.

Lifting beam – A long steel beam usually constructed in “H” section or similar weight bearing construction employed to spread the load when lifting long or awkwardly shaped loads.

Lighthouses – Solid towers which, in the day time, serve as landmarks, and by night exhibit strong lights. These lights vary, so that navigators may recognise the coast they are approaching.

Lightening, also lightering – The process of transferring cargo from a tanker to another ship. Also discharging a part of cargo into a lighter to reduce the vessel draft so it can then get alongside a pier.

Lightening hole – A hole cut in any member to reduce weight.

Lighter – A small **barge** for carrying cargo between ship and shore.

Lighterage – carriage of goods by **lighter** and the charge assessed therefrom.

Lightest seagoing condition – The loading condition with the ship on even keel, without cargo, with 10% stores and fuel remaining and in the case of a passenger ship with the full number of passengers and crew and their luggage.

Lighting – The lighting of crew spaces should facilitate visual task performance and facilitate the movement of crew members in the space and aid in the creation of an appropriate visual environment. Lighting design involves integrating these aspects to provide adequate illumination for the safety and well-being of crew as well as for the various tasks performed on board vessels.

***Note:** Lighting criteria for different spaces can be found in ABS guide for “Crew Habitability on Ships” - can be downloaded from: www.eagle.org*

General lighting – Lighting designed to provide a uniform level of **illuminance** throughout an area, excluding any provision for special, localized task requirements. Such lighting should be provided by fixed **luminaires**.

Task lighting – Lighting provided to meet the **illuminance** requirements of a specific task. It refers to the total illuminance requirement that may be obtained by supplementary

Lightship

lighting provided in addition to the general illuminance. Such lighting may be provided by fixed luminaries or via wall brackets, floor lamps or table lamps.

Lightship – The lightship is a ship complete in all respects, but without consumables, stores, cargo, crew, passengers and their belongings and without any liquids on board except for machinery and piping fluids, such as lubricants and hydraulics which are at operating levels.

Lightship draught – The mean draught of an empty vessel.

Lightship mass – The mass of the ship in metric tons without cargo, fuel, lubricating oil, ballast water, fresh water and feed water in tanks, consumable stores, passengers and crew and their belongings. Lightship mass has big influence on ship price and efficiency. It is necessary to take all reasonable measures in order to decrease lightship weight. The hull structure should be designed with great care, and light, compact equipment installed.

To systematize calculations of lightship mass it is necessary to organize ship components into weight groups.

Lightship mass of the container vessel 2700TEU equipped with four cranes

$L_{BP} = 196.00\text{m}$, $B = 32.26\text{m}$, $D = 19.00\text{m}$, Design draught = 10.00m, LBD = 126 136m³, Hull coefficient **73.98** kg/m³, lightship mass coefficient **102.56** kg/m³

	Weight classes	Weight (T)	%	VCG (m)	LCG (m)
1	Hull, Superstructure, Funnel	9331	72.12	11.58	88.07
2	Deck Equipment with Hatch Covers and Cranes	1367	10.57	20.15	105.10
3	Accommodation and Painting	416	3.21	19.86	44.34
4	Machinery	1073	8.29	9.42	21.21
5	Piping Systems	505	3.90	12.33	47.18
6	Electric Equipment	170	1.31	16.36	54.76
7	Special Equipment	41	0.32	15.25	57.04
8	Inventories	31.5	0.24	14.19	30.16
	Total	12938		12.68	80.64

Lightship mass coefficient – Estimation of lightship mass is one of the most important tasks when a new ship is designed. In the preliminary design stage, the lightweight can be derived from the masses of a parent ship. For vessels having similar arrangements the coefficient P/LBD can be used.

P = lightship mass, **L** = Length between perpendiculars, **B** = Breadth, **D** = Depth

HTS = percentage of high-tensile steel used in construction.

SHIP	L m	B m	D m	LBD m ³	P tonne	P/LBD kg/m ³	HTS %
Bulk carriers							
IVS VISCOUNT	172.00	28.00	15.20	73203	9058	123.7	15
CINNAMON	177.00	23.70	14.20	59568	8172	137.2	18
AZZURA	181.00	32.20	17.30	100828	8912	88.4	60

SHIP	L m	B m	D m	LBD m ³	P tonne	P/LBD kg/m ³	HTS %
SPAR LYRA	183.05	32.26	17.50	103340	11600	112.3	43
PROTEFS	217.00	32.20	19.20	134158	12405	92.5	
TAI PROGRESS	217.00	32.26	19.50	136508	10532	77.2	70
ANANGEL INNOVATION	279.00	45.00	24.30	305086	24738	81.1	55
TEH MAY	279.00	45.00	24.50	307597	22766	74.0	70
KOHYOHSAN	279.00	45.00	24.10	302575	21235	70.2	
ANANGEL INNOVATION (double-skin)	279.00	45.00	24.30	305086	24738	81.1	55
Container carriers (TEU)							
CIMBRIA 2824	210.00	30.00	16.80	105840	11891	112.3	35
APL VENEZUELA 3108	210.20	32.24	18.70	126727	15041	118.7	40
TMM COLIMA (4 cranes) 3237	232.40	32.20	19.50	145924	15728	107.8	55
AMARANTA 4444	271.20	32.20	21.80	190371	21382	112.3	33
PUSAN SENATOR 4571	283.20	32.20	21.80	198795	18945	95.30	50.9
VENUS 4850	280.80	32.24	21.60	195545	22100	113.0	33
APL KOREA 4826	262.00	40.00	24.30	254664	24130	94.75	53
HYUNDAI INDEPENDENCE 5551	263.00	40.00	24.20	255384	22876	89.6	49.6
COPIAPO 5527	263.80	40.00	24.20	255358	22959	89.9	54
HANJIN LONDON 5302	265.00	40.30	24.10	257376	25832	100.4	64
MSC STELLA 6400	292.00	40.00	24.20	282656	26956	95.4	50
Oil tankers							
BRITISH ENERGY	174.50	27.40	17.60	84151	8344	99.2	
BORAQ	174.00	32.20	18.80	105332	9950	94.5	
TARANTELLA	176.00	32.20	17.20	97476	10394	106.6	31.5
NEVSKIY PROSPECT ice class	239.00	44.00	21.00	220836	18600	84.2	
VLCC HARAD	318.00	58.00	31.25	576375	47800	82.9	45
VLCC IRENE SL	319.00	60.00	30.40	581856	43658	75.0	
VLCC WORLD LION	320.00	58.00	31.20	579072	42500	73.4	36
ULCC HELLESPONT	366.00	68.00	34.00	846192	67591	79.9	38
Product tankers							
BITFLOWER	108.90	16.45	9.85	17645	3174	179.9	
KIISLA (DNV ice class ICE IA)	132.10	21.70	12.15	34829	5661	162.5	38
FURE NORD	134.40	21.50	12.50	36120	5557	153.8	
ALNOMAN	168.00	31.00	17.20	89578	8779	98.0	30
BRITISH LIBERTY	174.00	32.20	18.80	105333	9439	89.6	
Gas carriers							
NORGAS ORINDA	115.00	19.80	11.50	26185	4900	187.1	
POLAR VIKING LPG	195.00	32.20	20.80	130603	9000	68.9	
BRITISH TRADER	266.00	42.60	26.00	294622	29800	101.1	
DISHA LNG	266.00	43.40	26.00	300154	30000	99.9	

Lightships

SHIP	L m	B m	D m	LBD m ³	P tonne	P/LBD kG/m ³	HTS %
GOLAR VIKING LNG	268.00	43.00	26.00	299624	29500	98.5	
LNG RIVERS	274.00	48.00	26.50	348528	34000	97.6	
Ro-Ro							
BALTICBORG	144.20	21.60	15.20	47344	5826	123.1	40
VILLE DE BORDEAUX	138.00	24.00	21.85	72367	8600	118.8	
MIDNIGHT SUN	241.48	35.96	27.43	238192	25868	108.6	
Offshore Support Vessels							
AHTS ANGLIAN PRINCESS	57.20	15.50	7.50	6650	2273	341.8	
ARMADA SALMAN	62.80	20.00	6.50	8164	2046	250.6	
PSV VIKING ENERGY	81.60	20.40			4116		
BOA DEEP C	102.00	27.00	11.60	31946	9493	297.1	
KNIGHT cable layer	128.60	21.00	17.10	46180	7737		
FPSO							
SEAROSE	258.00	46.00	26.60	315689	50150	158.9	73

Lightships – Red vessels on some hidden rock, reef or sand, and by night exposing characteristic lights. Their object is to mark outstanding dangers or port approaches.

Lightweight check, lightweight survey – A procedure which involves auditing all items which are to be added, deducted or relocated on the ship at the time of the inclining test so that the observed condition of the ship can be adjusted to the lightship condition. The weight and longitudinal, transverse and vertical location of each item are to be accurately determined and recorded. The lightship displacement and longitudinal center of gravity (LCG) can be obtained using this information, as well as the static waterline of the ship at the time of the **inclining test** as determined by measuring the freeboard or verified draught marks of the ship, the ship hydrostatic data and the sea water density.

Limber hole – A small hole cut in a plate near the bottom of the frame or other structural member to permit the passage of water or oil.

Line entanglement freeing system, also cutter system, net protector – Cutter blades mounted on the propeller to sever fishing lines, drift nets or discarded tow lines and hawsers.

Cutters cut lines and nets with each propeller revolution before entanglement and seal damage occurs.

Line throwing appliance – A gun or rocket device which can project a light line between vessels.

Useful website: www.comet-pyro.de

Liner conference – Shipping companies operating a service in common between designated areas. Conference partners agree on special freight rates and terms for the trade in order to stabilize market and service.

Liner service – Cargo ships (liners) operating on fixed itineraries or regular schedules and established rates available to all shippers.

Lines, Lines Plan – A set of lines showing the moulded form of the hull projected on three planes perpendicular to each other. It consists of three views:

- The elevation or **profile of the hull**,
- A view down upon it, known as the **half-breadth plan**,
- A set of transverse sections, known as the **body plan**.

Linkspan – Adjustable bridge ramp at specially-constructed berth, designed to link up with axial stern **ramps** of **ro-ro vessels**. There are different types of linkspans:

- Movable ramps, hinged onto the quay,
- Floating pontoons, equipped with a hinged bridge to the shore,
- Semi-floating ramps hinged onto the quay,
- Passenger walkways, complete systems of fixed and movable sections connecting the terminal to the vessel.



Double-level linkspan – If the **ro-ro ferry** has two or more trailer decks, a double level link spans with direct access also to the upper cargo deck saves much time for loading and unloading in port.

Lip seal – A shaft seal used to prevent the entry of the seawater or loss of oil from a stern tube bearing. A circular rubber ring is held against the rotating shaft by springs and the existing pressure.

Liquefaction – The change into a liquid state. It usually refers to the conversion of a gas into a liquid, which requires the gas to be cooled below its critical temperature and sometimes compressed as well.

Liquefied CO₂ carrier CORAL CARBONIC

According to **HSB International** December 1999

Built in 1999 by Frisian Shipyard Welgelegen, the Netherlands, the CORAL CARBONIC is the world first vessel designed for the carriage of liquefied CO₂. The single pressurised cylindrical tank with an internal diameter of 6400 mm and length of 40,182 mm has a capacity of 1250m³. The tank, suitable for the maximum working pressure of 18 bar, rests on two tank saddles: one fixed support and one sliding support allowing the tank to expand or shrink

Liquefied natural gas (LNG)

due to thermal loads. It is thermally insulated by 150mm thick polyurethane foam. A dome containing the entrance, pipe connections and the cargo **deepwell pump** is positioned on the aft part of the tank. The cargo pump is a vertical deepwell pump with top-mounted 129kW electric motor. The pump has a maximum capacity of 250 m³/h at 120mwc pumphead. The cargo tank is fitted with stainless steel lines, viz. a gas line, a liquid loading/discharging line, and a safety relief system, and connections for measuring instruments and cargo sampling. A gas/liquid manifold is fitted at port and starboard.

Length, oa: 79.4m, Length bp: 74.00m, Breadth, mld: 13.75m, Depth: 6.55m, Draught: 4.00m, Deadweight: 1600t, Minimum temperature: -40°C, Propulsion power: 1800kW, Service speed: 12.5 knots.

Liquefied natural gas (LNG) – Natural gas comes from natural sources and is composed of methane, ethane, propane and small amount of butane. It is condensed to about 1/600 of the volume by cooling it to below the -160°C, its boiling point, to produce LNG.

Liquefied petroleum gas (LPG) – Liquid petroleum gas, produced during the refining of **crude oil** or rich/wet natural gas and made up of propane and butane with some propylene and butylene.

Liquid cargo – Cargo with a vapour pressure below 2.75 bar absolute at 37.8°C.

Liquid cargo ships – see **tankers**.

Liquid chemical waste – Substances, solutions or mixtures, offered for shipment, carried for dumping, incineration or other methods of disposal other than at sea.

Liquid penetrant inspection – Procedure used for surface inspection of hull welds. A liquid penetrant, which may be a visible red liquid or a fluorescent yellow-green liquid, is applied evenly over the surface being examined and allowed to enter open discontinuities. After a suitable dwell time (minimum 5 minutes), the excess surface penetrant is removed. A white developer is applied to draw the entrapped penetrant out of the discontinuity and stain the developer.

Further reading: *ABS Guide for “Nondestructive Inspection of Hull Welds” (2002), can be downloaded from www.eagle.org*

Liquid pitch carrier SUNBIRD ARROW

According to **The Motor Ship** September 2005

At present, vessels that transport liquid **pitch** number only eight on the international market and the vessels have only 9,000-10,000 tonne capacity to transport this key material for aluminium production. With the delivery of 15,000DWT SUNBIRD ARROW, Gearbulk has the largest liquid pitch carrier in the world. Classed by DNV, the tanker is certified for carriage of chemicals (IMO 2) and oil products with independent cargo tanks and has a class notation as a tanker for molten coal tar pitch, molten naphthalene and coal tar naphtha solvent. With a cargo tank capacity of 13,720 m³, the vessel is designed to carry a wide variety of liquids in the 10 tanks which additionally include creosote, crude tar, **asphalt, bitumen** and oil products which do not require coated cargo holds.

Liquid pitch has to be transported at 200°C and the cargo tank insulation is sufficient to prevent a drop of temperature of more than 1 degree C/24h for fully loaded tanks without heating. Cargo handling is carried out by three (one for standby) positive displacement type pumps each with a capacity of 450 m³/h giving a discharge time of 17 hours. Maximum loading rate is 2000m³/h into four tanks simultaneously.

A single CP propeller driven by a 7175kW slow-speed engine will give the vessel a service speed of 14.5 knots. To aid manoeuvrability, a 790kW constant rpm bow thruster with a CP

propeller is fitted in addition to a high performance Shilling rudder. The electrical power plant comprises two 880kW medium-speed diesel engines with NTAKL-VC Nishishiba generators, each providing 1000KVA. In addition there is a Nishishiba shaft generator with an output of 1250KVA.

Length, oa: 144.0m, Length bp: 134.00m, Breadth, mld: 23.50m, Depth: 13.50m, Draught: 8.80m, Deadweight: 15,000t, Service speed: 14.5 knots.

Liquid transfer operations – Liquid cargo loading and unloading, ballasting and deballasting, ballast water exchange and tank cleaning operations.

Every tanker is to comply with the intact stability criteria for any operating draught reflecting actual, partial or full load conditions, including the intermediate stages of liquid transfer operations.

List – If the centerline plane of a ship is not vertical, as when there is more weight at one side than at the other, she is said to list, or to heel.

List indication lights – Lights visible from the deck showing that a ship is listing.

Livestock carriers – Vessels designed to carry live animals. Ventilation and drain systems are of crucial concern. They are usually converted second-hand ships used to carry live sheep from Australia to the Gulf.

LNG cargo containment systems – LNG has three major characteristics as a seaborne trade cargo: the super low temperature (-160°C), a low specific gravity (0.43 to 0.50) and flammability. Up to now, various cargo containment systems designed to handle these characteristics have been put into practical use. The main competing systems are French **membrane technology**, and Japanese and Norwegian self-supporting tanks (**Moss Rosenberg system**), structurally independent of the ship structure.

See also **Membrane-type cargo containment system**.

LNG re-gasification vessel GDF SUEZ NEPTUNE

GDF SUEZ NEPTUNE was built by Samsung Heavy Industries (SHI), Korea, and delivered to her operator Hoeg LNG, on 30th November 2009. The vessel has a transport capacity of some 145,000 m³ and a contract price of about \$290M.

Compared to a standard LNG carrier the vessel has a number of additional features including three skid-mounted re-gasification units supplied by Wärtsilä Hamworthy, turret mooring and discharging arrangements, as well as specialized equipment to reduce and contain emissions to air and water during the cargo processing and handling cycle.

The onboard vaporization plant allows the ship to convert her liquefied cargo back into the gaseous state, for direct transfer ashore into the natural gas distribution grid. The discharge can be accomplished offshore using submerged turret technology.

In the cargo dispatch process, LNG is pumped from the tanks to the re-gasification units on the weather deck offering a re-gasification capacity of 210t per hour of LNG with a send-out pressure of 115 bar. Pressure is boosted using cryogenic LNG pumps, and steam generated by auxiliary boilers. The re-gasified LNG is discharged via a turret and swivel through a mooring and unloading buoy connected to riser and subsea pipeline.

Since its specification for the first, pioneering dual-fuel-electric LNG carriers, commissioned in 2006, the Wärtsilä 50DF engine has become the prime mover of choice in LNGC electric propulsion systems. Four Wärtsilä 50DF engines drive the ABB generators, three rated at

LNG re-gasification vessel GDF SUEZ NEPTUNE

12,941kVA and one at 6470kVA. The prime movers are three 12-cylinder vee-form engines and one six-cylinder in-line engine, in aggregates delivering electrical energy to a pair of ABB 13.2MW propulsion motors and other shipboard consumers. The motors drive a single, fixed pitch propeller via a gearbox. The multi-engine, electric propulsion plant gives a high degree of operating flexibility. SHI claims that this system provides 30% higher efficiency than the more common steam turbine system.

ABB delivered a complete, fully integrated electrical system package. Besides the four synchronous-type, 6.6kV main generators, two synchronous-type propulsion motors and associated ACS6000 drives, four propulsion transformers and propulsion control system, two main switchboard, one re-gasification and two cargo switchboards, two thruster motor starters, and other equipment.

Length, oa: 283.06m, Length, bp: 270.00m, Breadth, mld: 43.40m, Depth to main deck: 26.00m, Draught design/scantling: 11.4/12.4m, Deadweight design/scantling: 70,860/80,980dwt, Service speed (21% sea margin): 19.5knots, Cargo capacity: 145,130m³, Main engines: 3 x Wärtsilä 12V50DF + 1 x Wärtsilä 6L50DF, Propulsion motors: 2 x ABB A/S 13,200kW.

LNG Reliquefaction System

LNG carriers have, up to 2006, mainly been driven by steam turbines. The **boil-off gas** (BOG) from the LNG cargo has so far been used as fuel. Instead of previous practice using BOG as fuel, the Wärtsilä Hamworthy reliquefaction system establishes a solution to liquefy the BOG and return the LNG back to the cargo tanks.

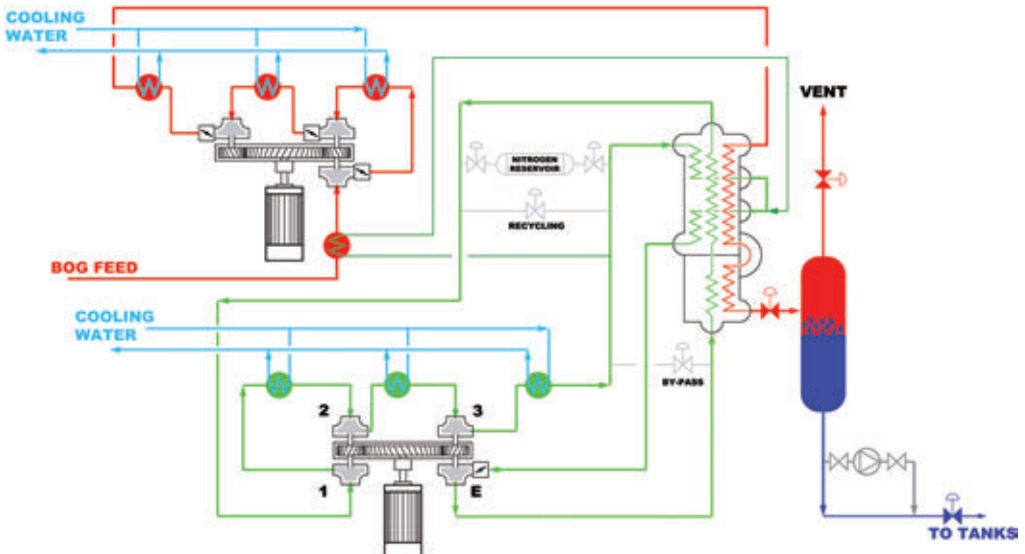

Wärtsilä Hamworthy third generation (Mark III) LNG reliquefaction system

BOG is removed from the cargo tanks by means of a two stage centrifugal compressor. The BOG is cooled and condensed to LNG in a cryogenic heat exchanger (cold box). Non-condensable items, mainly nitrogen, are removed in a separator vessel. From the separator, the LNG is returned to the cargo tanks by the differential pressure in the system. The cryogenic temperature inside the cold box is produced by means of a nitrogen compression-expansion cycle. The boil-off gas compressor capacity is adjusted

automatically in accordance with the boil-off rate. Increasing and decreasing the nitrogen filling - and thus the compressor mass flow - is the basic control mechanism for the cooling capacity of the nitrogen cycle. Sensors and transmitters provide the required input signals to a programmable logic controller which will be part of the main vessel control system and enables 0-100% capacity control.

The main difference compared with the first generation is that the compressor unit has an additional compressor stage and inter-stage cooling. Heat is added to the boil-off gas before it enters the main cooling circuit so that the heat of compression can be removed at high temperatures in the cooling arrangement. The additional compressor stage allows the process to condense the boil-off gas at high pressure and temperature. This effect and that the heat of compression is removed early in the process is the main reason whereby the power consumption is reduced by some 15%.

For further information please visit www.wartsila.com

LNG RV (LNG re-gasification vessel) – A new type of **LNG tanker** provided with re-gasification facilities. A tanker having loaded a LNG cargo in the conventional way regasifies the cargo on board and discharges the high-pressure gas at an offshore buoy or floating terminal. Gas is then fed directly into the consumer grid system through a dedicated mooring arrangement and sub-sea pipeline, thereby by-passing the need for a costly shore terminal which would normally carry out this process.

Discharge can be done either through deck manifolds or via a submerged **turret** mooring and offloading (STL) system, employing a turret installed at the bow. A buoy is moored to the seabed at the terminal and this is pulled into, and secured to, the turret mating cone in the ship bottom. A swivel in the turret allows the ship to weathervane without the aid of propulsion.

However, the vessel is free to roll and pitch and the cargo tanks and hull structure must withstand the sloshing loads which could be generated.

Delivered in 2005 by Daewoo Shipbuilding & Marine Engineering Co Ltd (DSME), the 138 000m³ EXCELSIOR is the first LNG vessel able to self discharge direct to a **single buoy mooring** (SBM) or into the local gas grid. The new vessel has been developed by DSME from its standard LNG tanker design, to which has been added re-gas plant and an internal turret for sub-sea pipe connection and weather-vane mooring. Cargo tanks and the supporting structures have been significantly reinforced because the LNG RV will be operating under partially filled tank conditions involving cargo sloshing. Additional equipment has been provided, with three 620m³/h feed pumps supplying a re-gas process. The re-gasification capacity is 500 million cubic feet per day, ensuring that a full cargo can be converted to high-pressure natural gas in five-to-six days. See also **ENERGY BRIDGE concept**.

LNG tanker – A highly-sophisticated gas carrier with very specialized LNG cargo containment system built for transportation of natural gases in bulk. As it is usual with LNG tankers, the cargo is transported at a temperature of -160°C.

METHANE PIONEER was the first ship to carry LNG internationally, on a voyage from the Trunkline Terminal at Lake Charles, Louisiana to the British Gas facility on Canvey Island in the UK in 1959. Until then no one could be sure of the effectiveness of insulation systems and many possible designs have been developed and evaluated. METHANE PIONEER was a converted freighter, fitted with 5 tanks with balsa wood and glass fibre insulation. Her successful crossing of the Atlantic with 5000 m³ of LNG conclusively demonstrated the

feasibility of internationally traded LNG and marked the start of the LNG era. The first two commercially viable methane carriers; METHANE PROGRESS and METHANE PRINCESS, entered their service in 1964. Each of them carried 27,400m³ of gas.



Picture courtesy of Wärtsilä Corporation

Electrically driven LNG carrier WOODSIDE ROGERS

The four central tanks has a total capacity of 159,760m³. The electric drive system is supported by four tri-fuel Wärtsilä 9L50DF engines, which are installed in two separate engine rooms.

One of the main requirements of LNG carriers has been the need to use the boil-off gas from the cargo in the propulsion system. Steam turbine was used as a prime mover and steam was generated by boilers burning oil or boil-off gas, or the combination of both. This type of propulsion is relatively inefficient and expensive to operate compared to diesel engines, especially when challenged by dual-fuel diesel-electric propulsion concept developed lately by Wärtsilä. The move away from steam turbines to diesel engines is the biggest step since a long time. Today many new LNG carriers on order will be powered either by boil-off gas driving diesel-electric installation, with dual fuel arrangements for the passage with no gas on board, or large two-stroke diesel engines burning conventional fuel, with their boil-off gas reliquefied on board.

Wärtsilä Oil & Gas Systems is the market leader with our LNG reliquefaction systems and recent years development shows that DF engines combined with LNG reliquefaction gives the most optimum and energy efficient systems.

Since the 1970s the deep-sea LNG carrier has grown quite slowly in size, from 125,000m³ to 138,000m³, and subsequently to 145,000m³, with the latest Gaz de France and BP projects having taken unit capacities to 154,000m³. The first ever really giant ships – of 216,000m³ were ordered in 2004. Q-max type MOZAH and her sisters, at 266,000m³, are the largest LNG carriers ever built, representing a 75% in capacity of traditional ship sizes and reflecting an economy of scale philosophy. See also **Cargo handling equipment of 138,000m³ LNG tanker, LNG containment systems.**

Further reading: ABS Guide for “Membrane Tank LNG Vessels” (2002), can be downloaded from www.eagle.org

LNG tanker BRITISH EMERALD

According to **Significant Ships** of 2007

Built by Hyundai Heavy Industries in Ulsan, the BRITISH EMERALD is the LNG tanker with dual-fuel diesel-electric propulsion. At 155,000 cubic metres she is one of the largest LNG carriers to date.

BRITISH EMERALD has a flat, single-deck, with sunken mooring deck aft, and a double-skin hull containing four membrane-type tanks for carrying cargoes at -163°C , constructed according to GTT Mk III system. Tanks extend above the upper deck and are enclosed in a trunk which provides access passages fore and aft. Tank insulation is 270mm thick. A shore manifold is arranged PS&SB between tanks 2 and 3 and a compressor room is situated on the starboard side of the trunk. Cargo is loaded by shore pumps, with unloading handled by two 1800m³/h electric, submerged pumps in each tank.



Picture courtesy of Wärtsilä Corporation

The 39,900kW power plant is based on four dual-fuel Wärtsilä 50DF engines. Two 12-cylinder vee-type DF engines, rated at 11,400kW, and two with nine cylinders in line models, producing 8550kW apiece, drive four Converteam generators. The four-engine arrangement and distribution of machinery in two separate engine rooms confers a high degree of redundancy.

Electrical energy is fed to a pair of 14.8MW synchronous propulsion motors, connected via a Renk twin-input/single-output reduction gearbox to a five-bladed propeller. The configuration enables various operating modes to be matched in the most efficient way, catering to fully-laden powering needs, in-habour loads, and in-ballast voyage, while the overall power concentration provides for a speed of 20knots.

The vessel will burn 40 tonnes per day (tpd) less fuel than a conventional LNGC of similar size which would burn about 180 tpd.

Other feature is the new technology of **cold ironing** facilities to allow the vessel to accept shore power whilst in port.

Length, oa: 280.00m, Length, bp: 275.00m, Breadth, mld: 44.20m, Depth to main deck: 26.00m, Draught design/scantling: 11.47/12.20m, Deadweight design/scantling: 76,600/84,300dwt, Service speed (15% sea margin): 20knots, Cargo capacity: 155,000m³, Main engines: 2xWärtsilä 12V50DF + 2xWärtsilä 9L50DF, Propulsion motors: 2 x Converteam 14,860kW.

LNG tanker GAZ DE FRANCE ENERGY

Although steam turbine propulsion has served LNG tankers well for a couple of decades, this type of propulsion is relatively inefficient and expensive to operate. Recent developments in engine technology are now enabling more efficient propulsion systems to be considered.



One of the most interesting alternatives is DF diesel-electric concept developed by Wärtsilä. This is the electric propulsion with main generators driven by dual-fuel engines. DF engines can use either **boil-off gas** or MDO as fuel. The main generators feed the ship electrical network and, through a variable-speed drive system, the propulsion motors. There is no need for auxiliary generator sets, so the total installed power can be reduced. With electric cargo pumps, one generator set should be sufficient to handle the power demand for cargo operation.

The 75,000m³ vessel built for Gaz de France at the French shipyard Alstom Chantiers de l'Atlantique is the first LNG tanker powered with dual fuel/diesel-electric concept. The power plant consists of four generating sets with Wärtsilä dual-fuel 6L50DF engines, each developing 5700 kW at 514 rev/min, and Leroy Somer 5500kW alternators. They supply power for domestic use, and for two 9500kW propulsion motors, also supplied by Leroy Somer. A Renk twin-input/single-output reduction gearbox is next in the driveline, making the connection from the motors to the single FP propeller.

The Wärtsilä 50DF engines are fully capable of switching over from gas to MDO automatically should the gas supply be interrupted. Whilst making maximum use of boil-off gas to develop useful power, the high efficiency of these engines calls for much lower fuel consumption overall. They are positioned in pairs, in two separate gas-tight compartments.

Claims made for the dual-fuel/diesel-electric system include a 30% increase in efficiency over the traditional steam turbine installation, plus added redundancy and a drastic reduction in emissions. A further bonus is the use of exhaust gas boilers to supply free heat to the cargo and hotel systems.

Length, oa: 219.50m, Length, bp: 208.50m, Breadth, mld: 34.95m, Depth to main deck: 22.00m, Draught design/scantling: 9.70/10.70m, Deadweight design: 35,000dwt, Service speed (85% MCR): 18.20knots, Cargo capacity: 74,500m³, Main engine: 4xWärtsilä 6L50DF, Output/speed: 4 x 5700kW/145rev/min.

LNG TANKERS

Ship	INIGO TAPIAZ	DISHA	GOLAR VIKING	METHANE KARI-ELIN
Shipyard	Astillero Sestao	Daewoo	Hyundai	Samsung
Year	2003	2004	2004	2004
LOA	284.40m	277.00m	280.00m	278.80m
LBP	271.00m	260.00m	268.00m	266.00m
B (Beam)	42.50m	43.40m	43.00m	42.60m
D (Depth)	25.40m	26.00m	26.00m	26.00m
Cargo capacity	138,000 m ³	138,000m ³	140,027m ³	138,200m ³
Tank number	4			4
Tank type	Membrane GTT NO96 E-2	Membrane GTT NO96 E-2	Membrane	Membrane GTT (Mk III)
Cargo pumps	8 x 1700m ³ /h			8x1700m ³ /h
Draft design d1	11.40m	11.40m	11.40m	11.35m
Draft max d2	12.30m	12.50m	12.30m	12.00m
Deadweight design	68,200dwt	70,150dwt	70,000dwt	68,250dwt
Deadweight max		81,100dwt	79,900dwt	74,000dwt
Displacement 1				
Displacement 2		111,100tonnes	109,400tonnes	
Lightweight		30,000tonnes	29,500tonnes	
Gross tonnage	93,450	94,058	93,750	
Main Engine	Steam turbine	Steam turbine	Steam turbine	Steam turbine
Type		Kawasaki UA360	MS40-2	Kawasaki UA400
MCR (kW)	28,000kW	26,480kW	27,940kW	29,044kW
Fuel Consumption		166.8t/d	174t/d	171.7t/d
Trial speed	21knots			
Service speed 90%MCR	19.50knots	19.50knots	19.70 knots	20.10 knots (85%MCR)
Propeller (Type,diameter.)	FP, 8700	FP, 8500	FP, 8600	FP, 8250
Complement		38	29 + 4	36

Ship	EXCELSIOR	ENERGY ADVANCE	TEMBEK Q-flex class	MOZAH Q-max class
Shipyard	Daewoo	Kawasaki	Samsung	Samsung
Year	2005	2005	2007	2008
LOA	277.00m	289.53m	315.00m	345.00m
LBP	266.00m	277.00m	303.00m	332.00m
B (Beam)	43.40m	49.00m	50.00m	53.80m
D (Depth)	26.00m	27.00m	27.00m	27.00m
Cargo capacity	138,800m ³	145,410m ³	216,200m ³	266,000m ³

Load Line Convention

Tank number	4	4 spherical tanks	5	5
Tank type	Gaz Transport NO96 E-2	Moss	GTT Mk III membrane	GTT Mk III membrane
Cargo pumps	8x1700m ³ /h	8x1500m ³ /h	10x1400m ³ /h	10x1400m ³ /h
Draft design d1	11.50m	11.40m	12.00m	12.00m
Draft max d2	13.20m	12.40m	12.50m	12.20m
Deadweight design	68,130dwt	71,586dwt	100,800dwt	126,800dwt
Deadweight max	76,130dwt		107,000dwt	130,000dwt
Displacement 1				
Displacement 2				
Lightweight				
Gross tonnage	93,800	119,233		163,922
Main Engine	Steam turbine	Steam turbine	2 x low speed	2 x low speed
Type	Kawasaki UA360	Kawasaki UA400	2 x MAN B&W 6S70ME-C	2 x MAN B&W 7S70ME-C
MCR (kW)	26,650kW	26,900kW	2 x 17,300kW	2 x 18,900kW
Fuel Consumption	170t/d	165t/d	116.5t/d ME	124.5t/d ME
Trial speed				
Service speed 90%MCR	19.10 knots	19.50 knots	19.50knots at 85% MCR	19.50knots at 85% MCR
Propeller (Type/diameter.)		FP, 9500	2 x FP, 7600	2 x FP, 7900
Complement	34 + 6	43	37 + 8	37 + 8

Further reading: ABS Guide for "Propulsion Systems for LNG Carriers" (2005), can be downloaded from www.eagle.org

Load Line Convention – see International Convention on Load Lines, 1966.

Load line mark – Ships must have a load line mark located amidships on both sides to indicate the maximum allowable draught under specified conditions (geographical and seasonal).

The International Convention on Load Lines 1966 (ICLL 1966) with its Protocol of 1988 is a comprehensive set of regulations to determine the minimum allowable **freeboard** and defines the conditions of load line assignment. The minimum geometric summer freeboard is computed by taking a freeboard for a standard ship of the same length



(provided in tabular form) and correcting it for those geometric properties of the ship which differ from those of the standard one. There are corrections for block coefficient, depth, superstructure, trunks and sheer. The result of this calculation, the load line mark, is permanently marked on the ship hull.

The calculation of the minimum freeboard must be approved by a classification society which defines the eventual location of the load line marks based on the measurement of built vessel. Marks cannot be welded to the sides of the hull during construction, even though some shipyards would be eager to proceed in this manner.

In the case of a ship being assigned a freeboard greater than minimum so that the load line mark is marked at a position corresponding to or lower than the lowest seasonal load, and line assigned at a minimum freeboard is in accordance with the calculation procedure, only the Fresh Water Load Line needs to be marked. Such load lines are termed "All Seasons Load Lines" and are illustrated in the photo below.

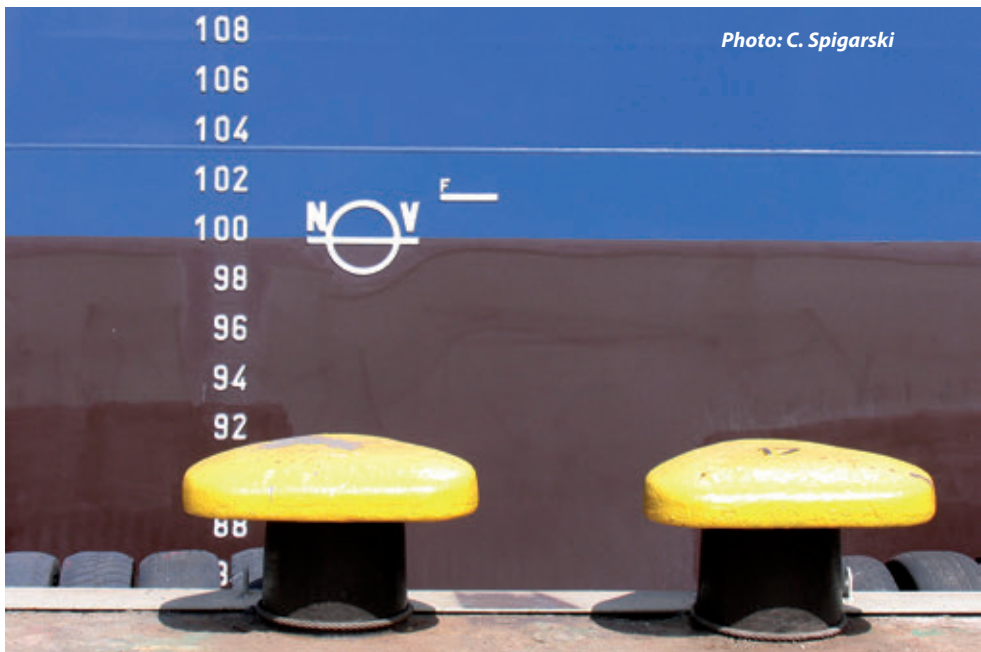

All Seasons Load Lines

The assignment of the computed freeboard is conditional upon the prescribed means of protection and closure of openings such as hatchways, doorways, ventilation, air pipes, scuppers and discharges being complied with. Regulations are also included for freeing ports in bulwark to prevent water accumulating on deck, as well as guard rails and walkways to provide safe passage.

Loader – Shore-based equipment used to load the holds of a cargo ship (e.g. conveyor belt).

Loading and Stability Manual – According to **SOLAS** Convention every passenger ship regardless of size and every cargo ship having a length L of 24m and upwards, must be provided with such information (given in a simple and understandable form) as is necessary to enable the master to obtain accurate guidance as to the **stability** of the ship under various conditions of service.

MSC/Cir.920 dated 15th June 1999 defines the scope of onboard stability documentation, named **Loading and Stability Manual**. Despite that, onboard stability documentation can have very different scope and form. Very often various names are used: Intact Stability Information, Stability Booklet, etc. These terms are not sufficient to describe properly and fully the actual content of onboard stability documentation that takes into account requirements of damage stability and contains strength calculations.

Mass of empty ship and locations of its centre of gravity are parameters necessary for any stability calculations. Therefore any stability documentation must be prepared in two steps.

At the technical design stage it is necessary to prepare a preliminary documentation in order to submit it for class approval. It is carried out for estimated values of the lightship mass and location of the centre of gravity.

The true value of lightship mass and the true location of the ship centre of gravity can be determined only on the base of the inclining test carried out upon the completion of the vessel. Only then the final stability documentation can be prepared and approved.

Very often the scope of the preliminary documentation is limited just to calculations necessary to show the stability of the vessel meet the criteria in all standard loading cases. Such practice is the main reason of delays and low quality of the final documentation. Both documentations should have a very similar scope and form. With the preliminary documentation being approved, the preparation of the final documentation could be just a revision of calculations for ship's actualized data.

Further reading: "Ship Stability in Practice"

Loading arms – Transfer units between ship and shore for discharge and loading oil or any liquefied gas; there are articulated all-metal arms (hard arms) or a combination of metal arms and hoses.

Loading conditions of bulk carrier:

Alternate hold loading condition – Heavy cargo, such as **iron ore**, is often carried in alternate cargo holds on bulk carriers. It is common for large bulk carriers to stow high-density cargo in odd numbered holds with remaining holds empty.

Block hold loading condition – A block hold loading condition refers to the stowage of cargo in a block of two or more adjoining cargo holds with the cargo holds adjacent to the block of loaded cargo holds empty.

Homogeneous hold loading condition – A homogenous hold loading condition refers to the carriage of cargo evenly distributed in all holds. This arrangement is usually adopted for the carriage of light cargoes, such as coal or **grain**.

Further reading: IACS Rec.46 "Guidance and Information on Bulk Cargo Loading and Discharging to Reduce the Likelihood of Over-stressing the Hull Structure"

Loading instrument – An instrument by means of which it can be easily and quickly ascertained that the still-water bending moments and shear forces will not exceed the specified values in any load or ballast condition.

Loading overall – The loading of cargo or ballast "over the top" through an open-ended pipe or by means of an open-ended hose entering a tank through a hatch or other deck opening, resulting in the free fall of liquid.

Loading rate – The rate of loading of a particular type of shore-based equipment (measured in tons/hour).

Loads – A ship at sea encounters many types of loads and forces simultaneously, such as wave-induced bending and shear torsion, impact of waves on the sides, deck and bottom, static loads from cargo and the sea, as well as sloshing. Additionally, the ship may be loaded in different ways depending on the trade and some loads may be quite large, stressing the structure near its strength limitations.

Bending load – An external load that produces bending stresses within a body.

Buckling load – The load necessary to cause buckling instability of a particular structure.

Critical load – The load that brings about a change in behaviour of a structure, such as buckling, yielding, fatigue, etc.

Distributed load – A load that acts over a part or the whole of the surface of the structure.

Dynamic load – A load that produces significant acceleration of a body.

Environmental load – A load that acts onto a structure that is the result of environmental conditions (e.g. thermal loads arising from temperature variations etc).

Static load – A load that results in the development of a stress field within a body without any acceleration of any part of it.

Local fire protection – Passenger vessels over 500GT and cargo ships over 2000GT with the keel laid after July 2002 will have to be fitted with local fire protection in machinery spaces in addition to the CO₂ system. Local fire protection requires a water-based extinguishing system as it can be activated quickly without the need to ensure all the crew is out of the engine room.

Location – The finding of ships, aircrafts or persons in distress.

Lock – A region of a canal or river which can be enclosed by gates. It is then filled or emptied in order to raise or lower ships whilst afloat.

Lofting – The process of developing the size and shape of the components of the ship hull structure from the designed lines.

Log – A device, which measures the distance travelled and the speed of a ship moving through the water.

Log book – A record book that the master of a ship is required to fill in during a voyage. Originally it was a book for recording readings from the log.

Longitudinals – Fore-and-aft structural shape or plate members attached to the underside of decks, flats, or to the inner bottom, or to the inboard side of the shell plating, in association with widely-spaced transverses, in the longitudinal **framing system**.

Longliner – A fishing vessel that employs a long main line supported by floats with shorter lines attached to it with baited hooks at their lower point. Shooting of the long line is done over the stern. The lines are hauled, the catch removed, the hooks rebaited, and the line reshot. The main advantages of this fishing method is high quality and selectivity of the catch.

Lookout –

1. Activity carried out by sight and hearing as well as by all available means appropriate for the prevailing circumstances and conditions to make a full appraisal of situation and the risk of collision.
2. A member of the crew stationed on the **forecastle**, or on the **bridge**, whose duty is to watch for any dangerous objects or for any other vessels heaving into sight.

Louver – An opening to the weather in a ventilation system, fitted with a series of overlapping vanes at about 45 degrees to the vertical intended to minimize the admission of rain or seawater spray to the opening.



Low flame-spread – Low flame-spread means that the surface thus described will adequately restrict the spread of flame, this being determined in accordance with the **Fire Test Procedures Code**.

Low heat value – Heat content of the fuel with the heat of vaporization excluded. The water vapour is assumed to be in a gaseous state.

Low NOx combustion – Wärtsilä developed combustion process which reduces the NOx emission level in the diesel engine by up to 25-35% without compromising on thermal efficiency. Low NOx combustion is based on:

- An high compression ratio that therefore gives an higher combustion air temperature at the start of injection, which drastically reduces the ignition delay.
- A late start of injection (retarded injection) and shorter injection duration to place combustion at the optimal point of the cycle with respect to efficiency.
- Improved fuel atomization and matching of combustion space with fuel sprays to facilitate air and fuel mixing.
- An early inlet valve closing (Miller timing).

Further reduction of NOx is achievable by **Direct Water Injection, CASS, Wärtsilä Wetpac Humidification** and **Selective Catalytic Reduction**.

LOW LOSS CONCEPT

Traditional diesel-electric propulsion consists of several generating sets and drive systems, each consisting of a propulsion transformer, a frequency converter for speed control, an electric motor and a thruster. The propulsion transformers are heavy and take a lot of space. Instead of a conventional propulsion transformers, the Wärtsilä LLC system uses a phase-shifting LLC transformers which filter out undesirable harmonic currents.

In LLC system, the main switchboard is constructed in four separate sections, each section connected to one genset. Thrusters are connected to the four switchboard sections in such a way that each frequency drive is fed by two gensets. If a failure occurs in one genset, electrical energy from the other aggregate can still be supplied to both propulsion motors.

Bus bars A1 and A2, as well as bus bar B1 and B2, are connected to each other via two LLC transformers. These transformers also feature secondary windings which eliminate the need for distribution transformers for other auxiliary customers.

In traditional systems, the use of low-voltage components is restricted to applications with a maximum of about 10MW installed propulsion power. By using LLC, the propulsion systems with higher installed power can be designed using low-voltage (690V) components, reducing equipment weight and saving valuable space. In some applications, weight reductions of 35-40% can be achieved.

The LLC systems are particularly suitable for dynamic positioned offshore support vessels due to their high redundancy. As a result, a required station keeping capability can be achieved with smaller installed power than in case of conventional diesel-electric systems.

Advantages of the Wärtsilä LLC technology:

1. Reduced losses in the vessel's electrical system (15-20%) result in fuel savings and lower levels of emissions.
2. Higher levels of availability when a major failure occurs increases thruster robustness.
3. Less-severe consequences in the worst single failure case mean that LLC solutions offers improved DP capability.
4. Increased operational flexibility and availability through a segregated, two-section switchboard and bus connections via buslinks.
5. Significant increase in levels of personnel safety due to the reduced likelihood of short circuits.
6. No inrush current at thruster start-up as the transformers are always energised.
7. Reduced weight and space requirements as the usual thruster transformers are not required.
8. Additional flexibility in vessel design as the LLC phase-shift transformers do not need to be located close to the electric drives for which they provide power. They also feature secondary windings which can be used to supply some of the vessel's auxiliary power requirements.
9. More efficient power distribution in damage scenarios.

Wärtsilä first complete LLC system was delivered in 2004 and installed on the Norwegian PSV NORMAND SKIPPER. The concept has subsequently been developed. Patents have now been granted for the Quattro LLC design and for LLC in medium-voltage application.

Lower flammable limit (LFL), lower explosive limit – The concentration of a hydrocarbon gas in air below which there is insufficient amount of **hydrocarbon** to support and propagate combustion. Sometimes referred to as lower explosive limit (LEL).

See also **Upper flammable limit**.

LPG reliquefaction plant

In a refrigeration cycle, the refrigerant circulates from the evaporator through the compressor to the condenser and back to the evaporator. In the evaporator, the heat added to the refrigerant by boiling off is taken from the surroundings. In the compressor an additional amount of heat is conveyed to the refrigerant by the compression process. In the condenser, the total heat is then removed from the refrigerant.

The principle of operation of the reliquefaction plant onboard a Very Large Gas Carrier (VLGC) is as described above. The cargo tanks act as evaporators and the cargo as

refrigerant and the seawater is the coolant for the condenser. The reliquefaction unit is built up around the cargo compressor; where the compressor is used to compress cargo boil off vapour to sufficient pressure to be liquefied against normally seawater. Reciprocating compressors with labyrinth seals of make Burckhardt Compression is the definite market leader. The compressor can have either two or three stages of compression. The traditional solution for a VLGC is to have four identical reliquefaction units installed. During loading all units are normally running in order to handle the displaced vapour and vapour generated due to heat input and flashing. These large gas carriers are designed to load two different types (grade) of cargos having physical segregation both in the liquid phase and vapour phase. When the vessel is loading two grades of cargo, at least one reliquefaction unit is dedicated to the less volatile cargo, normally Butane.



Picture courtesy of Wärtsilä Corporation

Reliquefaction plant onboard SANHA LPG FPSO

In recent years, Wärtsilä has developed a new proprietary system that has a higher efficiency than the traditional system. This new system is based on two large and identical reliquefaction units with a combined reliquefaction capacity in excess of the conventional four units. Additionally, a separate condenser unit for the less volatile cargo is installed. This condenser unit is using condensate from the more volatile cargo boil off vapour, normally Propane, as refrigerant.

The flow schematics for the two reliquefaction units are in principal identical to the conventional system. However, individual improvements are made on process equipments in order to further improve the overall performance. This new system uses two compressors of type Burckhardt 4K165-3P running at variable speed. Each of the new reliquefaction units has a reliquefaction capacity significantly exceeding the IGC requirements. This new design is able to handle all traditional types of cargo and cargo combinations including Propane with high Ethane content (>8%) opposed to the conventional systems that cannot handle higher Ethane content than 5%.

Liquefaction of second grade cargo vapour (the less volatile vapour) can either be done by one of the reliquefaction units or by the dedicated Butane condenser unit. The Butane condenser unit offers benefits during both loading and when loaded. During loading of two grades of cargo, currently for traditional systems at least one reliquefaction unit needs to be dedicated for the less volatile cargo. The available reliquefaction capacity is normally in excess of what is needed for loading and cool down of this cargo and means of transferring the excess reliquefaction capacity to the more volatile cargo would improve the loading rate. This is because loading takes place without vapour return and loading rate is thus controlled by the installed reliquefaction capacity. By introducing a dedicated condenser taking a side stream of the condensate from the more volatile cargo, the installed reliquefaction capacity is better utilized for both cargoes during loading. Vapour can either free flow to the condenser or by the aid of a dedicated blower, free flow is the preferred method. The condensed vapour is returned back to the cargo tanks using a dedicated return pump, this is regardless of free flow or blower operation. Particularly for blower operations it is important to minimize the compression heat input and thus a return pump is beneficial. Normally, blower operation is not required. Free flow of cargo vapour is driven by the temperature differences between the first grade condensate and second grade vapour.

For further information please visit www.wartsila.com



LPG tanker – A **gas carrier** built for the transportation of petroleum gases in bulk. LPG tankers often can carry some other gases such as ammonia, propylene and vinyl chloride. The cargo list for a LPG carrier specifies what type of cargoes the vessel shall be designed for. Practically all LPG carriers can handle LPG, ammonia, propylene and VCM. For larger gas carriers there is a tendency that some of the cargoes are removed from the cargo list. Wärtsilä Oil & Gas System has a significant market share in the delivery of cargo handling system for both LPG and LEG vessels.

Considering the temperature and the pressure needed, the LPG carriers can be divided into three categories: full pressure type, semi-refrigerated type and fully-refrigerated type. Small size ships (less than 4000m³ of cargo capacity) are usually the full pressure

type. The semi-refrigerated technique is used for the cargo spaces around 7500m³, and fully-refrigerated technique is intended for the cargo spaces between 10,000m³ and 100,000m³. See also **PTARMIGAN**.

Ship	ALMARONA	POLAR VIKING	BERGE DANUTA	CRYSTAL MARINE
Shipyard	STX Shipbuilding	HHI, Korea	Gdynia Shipyard	Kawasaki Shipbuilding
Year	2004	2004	2000	2003
LOA	164.80 m	204.90 m	225.75 m	227.50 m
LBP	155.30 m	195.00 m	218.58 m	222.00 m
B (Beam)	26.20 m	32.20 m	36.40 m	37.20 m
D (Depth)	15.30 m	20.80 m	22.00 m	21.00 m
Product range		Type 2G LPG	Type 2G	
Ship	ALMARONA	POLAR VIKING	BERGE DANUTA	CRYSTAL MARINE
Shipyard	STX Shipbuilding	HHI, Korea	Gdynia Shipyard	Kawasaki Shipbuilding
Cargo capacity		60,000 m ³	78,550 m ³	80,138 m ³
Tank number	3 pairs	4	4	4
Tank type	IMO type A			
Cargo pumps		8 x 500 m ³ /h		
Draft design d1	8.30 m	10.80 m		10.58 m
Draft max d2	8.50 m	11.90 m		11.20 m
Deadweight design	16,769 dwt	36,500 dwt	47,760 dwt	48,930 dwt
Deadweight max	17,466 dwt	42,700 dwt	56,823 dwt	53,395 dwt
Displacement 1			70,027 tonnes	
Displacement 2		51,700	79,090 tonnes	
Lightweight		9,000	22,267 tonnes	
Gross tonnage			49,288	
Main Engine	MAN B&W	MAN B&W	Sulzer	MAN B&W
Type	6S50 mC-C	5S60 mC-C	6RTA68 tB	7S60 mC-C
MCR (kW)	9480 kW	8746 kW	17,640 kW	14,000 kW
Fuel Consumption	34 + 4.24 t/day	34.76 t/day		48.4 t/day
Trial speed	17 knots			
Service speed 90%MCR		16 knots	18 knots 85%MCR	17 knots 85%MCR
Propeller (Type/ diameter.)	Fixed/5600	Fixed/7600	Fixed/7500	Fixed/7300
Complement	24 + 6	25+4	32+4	29+4

Further reading: *ABS Guide for "Liquefied Petroleum Gas Carriers with Type-A Independent Tanks"* (2006), can be downloaded from www.eagle.org

LPG tanker CELANOVAAccording to **Significant Ships** of 2003

CELANOVA has been built for service around the southern Spanish coasts and the Balearic Islands. She is a type 2G gas tanker designed to transport semi-refrigerated cargoes (-48°C, 6.5bar) in five type C, independent, cylindrical stainless steel tanks, carried on supports and surrounded by void spaces.

A Tractebel Gas Engineering handling and re-liquefaction plant is installed to deal with gases including propane, propane/butane, anhydrous ammonia, vinyl chloride monomer, i-butane, n-butane, butane, and butadiene. A direct-working system is employed, where reliquefaction of vaporised cargo is effected by means of three systems – a pressure decrease in the tanks, compression with condensation against seawater and expansion back into the tanks.

Three Sulzer direct-drive, labyrinth piston-type cargo compressors are provided, together with suction separators, flash drum-type cargo economisers, and LPG condensers. These, and the cargo heater/evaporator, and fresh water heating/cooling system, are fitted with titanium plate heat exchangers, and are installed in a deckhouse abaft the forecastle.

The cargo is handled using a 150m³/h electrically-driven **deepwell pump** in each tank, ensuring loading and unloading times, with vapour return, of around 10 hours. Two grades of cargo can be transported at the same time, and each can be cooled simultaneously. Two 150m³/h booster pumps are also fitted and arranged to work in series either with one or two cargo pumps.

A hydraulically-operated valve quick-closing system, using actuators fitted to valves in the cargo and vapour lines at crossovers and tank domes, operates to provide an emergency stop system. Other safety features include a detection system for identifying gas concentration in hazardous areas of the plant and inert gas installation, fitted with two absorbers filled with carbon monoxide sieves in the nitrogen production equipment.

Lubricating oil – A high boiling point product of the crude oil refining process, used to lubricate machinery. Various properties required are obtained by blending and the introduction of additives such as oxidation inhibitors, dispersants and detergents.

Lubrication – The process of minimizing friction and wear between moving metal parts by the formation of an oil film between them.

Luff (to) – To raise or lower a derrick or a crane jib.

Lumber carrier – A ship used for the transportation of lumber (timber) and other wood products.

Luminaire – A complete lighting unit consisting of a lamp(s) together with the parts designed to distribute the light, to position and protect the lamp and to connect the lamp to the power supply.

Luminance – The amount of light emitted from a source (including that reflected from a surface). Luminance is measured in candela-per-square-meter (cd/m²).

Machinery spaces – All **machinery spaces of category A** and all other spaces containing propulsion machinery, **boilers**, oil fuel units, steam and **internal combustion engines**, generators and major electrical machinery, oil filling stations, refrigerating, stabilizing, ventilation and air conditioning machinery and trunk to such spaces, (**SOLAS**).

Unmanned machinery space (UMS) – Machinery spaces that are controlled from the bridge rather than from a control room located within the engine room compartment.

Machinery spaces of category A – Those spaces and trunks to such spaces which contain either:

1. Internal combustion machinery used for the main propulsion,
2. Internal combustion machinery used for purpose other than the main propulsion where such machinery has in the aggregate a total power output of not less than 375 kW, or
3. Any oil-fired boiler or oil fuel unit, or any oil-fired equipment other than boilers, such as **inert gas generators**, incinerators, etc, (**SOLAS**).

Magna flux – A nondestructive examination of steel for surface and subsurface defects employing a dry or wet iron powder and a source setting up magnetic fields in the metal.

Magnetic particle test – A nondestructive testing technique using a mixture of iron filings in thin white paint which is spread over the surface to be examined. A large magnet is then attached over the area of interest and any discontinuities show up as concentrations of iron filings.

Further reading: *ABS Guide for “Nondestructive Inspection of Hull Welds” (2002), can be downloaded from www.eagle.org*

Maiden voyage – The first voyage of a new ship after handing over to the owner.

Main engine lubricating oil system – This system supplies lubricating oil to the engine bearings, and cooling oil to the pistons. Lubricating oil is pumped from ME LO Circulating Tank, placed in the **double bottom** beneath the engine, by means of the ME LO Pump, to the ME LO Cooler, a thermostatic valve, and through a full-flow filter, to the engine, where it is distributed to the various branch pipes. Pumps and fine filters are arranged in duplicate, with one as a standby. From the engine, the oil collects in the oil pan, from where it is drained to the ME LO Circulating Tank for reuse. A centrifuge is arranged for cleaning the lubricating oil in the system and the clean oil can be provided from a storage tank.

Main generating station – The space in which the **main source of electrical power** is situated, (acc. to **SOLAS** Chapter II-1, Part A).

Main propulsion power – The total power supplied by the prime movers installed to provide propulsion. This does not include the power provided by propulsion units which can be switched on when required but are not intended to provide propulsion during normal operation, e.g. shaft-driven generators in power take-in mode or additional **waterjet** propulsion units.

Main source of electrical power – A source intended to supply electrical power to the **main switchboard** for distribution to all services necessary for maintaining the ship in **normal operational and habitable condition**, (acc. to **SOLAS**, Chapter II-1, Part A).

Main vertical zones – These sections into which the hull, superstructure, and deckhouses are divided by “A” class divisions, the mean length of which on any deck does not in general exceed 40 m, (**SOLAS**).

Maintainability – The ability to carry out rapid and effective system restoration to keep the equipment at a specified level of performance.

Maintenance – A series of procedures aimed at preserving the function of an engineering structure or a piece of equipment throughout its expected lifetime. Most marine products include systems and parts that are subject to scheduled maintenance according to the instructions of the manufactures.

Breakdown maintenance – A policy of plant repair only after it has failed.

Condition based maintenance (CBM) – Preventive maintenance system based on using real-time data to prioritize and optimize maintenance resources, and allowing to act only when maintenance is actually necessary.

Planned maintenance – Organized & scheduled preventive maintenance work in order to minimize equipment downtime and to effectively utilize available resources.

Maintenance costs – The costs incurred in keeping equipment in an operational condition.

Maintenance of class – Classed ships are submitted to surveys for the maintenance of class, confirmation, or renewal of their term. Usually all ships having a 5-year term are subjected to annual surveys, intermediate survey and confirmation of the term survey. At the end of the term, the special survey is to be carried out. The special survey may be carried out on a continuous basis (continuous survey) or on distributed basis (distributed survey) during the term.

Maintenance work – Any action carried out to return or restore an item to an acceptable standard.

Maintenance tools – Maintenance of specific equipment requires special tools. Some of them are supplied with the equipment and others are available through service stations or for direct purchase by the customer.

Major failure of tanker – Deformation or rupture of a cargo tank, usually due to overpressurisation or underpressurisation.

Mandel shackle – A special shackle used to connect a wire mooring line to a synthetic tail.

Manhole – A round or oval hole cut in decks, tanks, etc, for providing access. Low manholes are used usually. Flush manholes can be installed in cargo hold walls, or inner bottom. Raised manholes are installed in walls that shall be insulated.

Manifest, Cargo Manifest –

1. A list of all cargo on board.
2. A term used also for passengers list on cruise vessels, passenger ferries, etc.

Manifold – A chamber functioning as a connection point for various valves and pipelines.

Manipulator – A remotely-operated work arm.

Manned facility – A facility with permanently-occupied living accommodations, or the one that requires continuous presence of personnel for more than 12 hours in successive 24-hour periods, (ABS).

Manning – The number of personnel forming the ship crew.

Manoeuvrability of the ship, manoeuvring capability of ship – **Manoeuvring characteristics** such as turning, yaw-checking, course-keeping and stopping abilities of the ship. Scale model tests and/or computer predictions using mathematical models can be performed

to predict the manoeuvrability of the ships at the design stage. Full-scale **manoeuvring tests** should be conducted to validate these results.

Manoeuvring performance has traditionally received little attention during the design stages of a commercial ship. Consequently, some ships have been built with very poor manoeuvring qualities that have resulted in marine casualties. "Standards for Ship Manoeuvrability" were adopted by resolution MSC.137(76) in December 2002 to ensure that ships are designed to a uniform standard.

Further reading: *ABS Guide for "Vessel Maneuverability" (2006), can be downloaded from www.eagle.org*

Manoeuvring characteristics – The IMO resolution MSC.137(76) "Standards for Ship Manoeuvrability" identify the following characteristics:

Inherent dynamic stability – A ship is dynamically stable on a straight course if it, after a small disturbance, soon will settle on a new straight course without any corrective rudder action. The resultant deviation from the original heading will depend on the degree of inherent stability and on the magnitude and duration of the disturbance.

Course-keeping ability – The course-keeping quality is a measure of the ability of the steered ship to maintain a straight path in a predetermined course direction without excessive oscillations of rudder or heading. In most cases, reasonable course control is still possible where there exists an inherent dynamic instability of limited magnitude.

Initial turning/course-changing ability – The initial turning ability is defined by the change-of-heading response to a moderate helm, in terms of heading deviation per unit distance sailed or in terms of the distance covered before realizing a certain heading deviation (such as the "time to second execute" demonstrated when entering the zig-zag manoeuvre).

Yaw checking ability – The yaw checking ability of the ship is a measure of the response to counter-rudder applied in a certain state of turning, such as the heading overshoot reached before the yawing tendency has been cancelled by the counter-rudder in a standard zig-zag manoeuvre.

Turning ability – Turning ability is the measure of the ability to turn the ship using hard-over rudder. The result being a minimum "advance at 90° change of heading" and "tactical diameter" defined by the "transfer at 180° change of heading".

Stopping ability – Stopping ability is measured by the "track reach" and "time to dead in water" realized in a stop engine-full astern manoeuvre performed after a steady approach at full test speed.

Manoeuvring criteria – The manoeuvrability of the conventional ship at full load is considered satisfactory if the following criteria are complied with:

- 1. Turning ability** – the advance should not exceed 4.5 ship lengths (L) and the tactical diameter should not exceed 5L in the turning circle manoeuvre.
- 2. Initial turning ability** – With the application of 10° rudder angle to port/starboard, the ship should not have travelled more than 2.5L by the time the heading has changed by 10° from the original heading.
- 3. Yaw-checking and course-keeping abilities**

The value of the first overshoot angle in the 10°/10° zig-zag test should not exceed:

- 10° if L/V is less than 10s,
 - 20° if L/V is 30s or more,
 - $(5+1/2(L/V))$ degrees if L/V is 10s or more, but less than 30s,
- where L and V are expressed in m and m/s, respectively.

The value of the second overshoot in the 10°/10° zig-zag test should not exceed:

- 25° if L/V is less than 10s,
- 40° if L/V is 30s or more,
- $(17.5+0.75(L/V))$ degrees if L/V is 10s or more, but less than 30s.

The value of the first overshoot angle in the 20°/20° zig-zag test should not exceed 25°.

- 4. Stopping ability** – The track reach in the full astern stopping test should not exceed 15 ship lengths. However, this value may be modified by the Administration where ships of large displacement make this criterion impracticable, but should in no case exceed 20 ship lengths.

Manoeuvring Information – Pilot card, wheelhouse poster and manoeuvring booklet as required by the resolution A.601(15) "Provision and Display of Manoeuvring Information on Board Ships".

Pilot card – The pilot card is intended to provide information to the pilot on boarding the ship. This information should describe the current condition of the ship, with regard to its loading, propulsion and manoeuvring equipment.

Wheelhouse poster – The wheelhouse poster should be permanently displayed in the wheelhouse. It should contain general particulars and detailed information describing the **manoeuvring characteristics** of the ship, and be of such a size to ensure ease of use.

Manoeuvring booklet – The manoeuvring booklet should be available on board and should contain comprehensive details of the ship **manoeuvring characteristics** and other relevant data.

Manoeuvring parameters according to **IMO** resolution MSC.137(76) "Standards for Ship Manoeuvrability" adopted on 4 December 2002.

Advance – The distance travelled in the direction of the original course by the midship point of ship from the position at which the rudder order is given to the position at which the heading has changed 90° from the original course.

Tactical diameter – The distance travelled in the direction of the original course by the midship point of ship from the position at which the rudder order is given to the position at which the heading has changed 180° from the original course. It is measured in a direction perpendicular to the original heading of the ship.

Typical values are tactical diameters of 4.5-7L for slender ships, and 2.4-4L for short and full vessels.

Test speed – A speed of at least 90% of the ship's speed corresponding to 85% of the maximum engine output.

Track reach – The distance along the path described by the midship point of a ship measured from the position at which an order for full astern is given to the position at which the ship stops in the water.

Manoeuvring speed – A vessel reduced rate of speed in restricted waters such as fairways, harbours, etc.

Manoeuvring tests – The full-scale trials conducted in order to evaluate such performance of a ship as turning, yaw-checking, course-keeping and stopping abilities. Manoeuvres required by **IMO** standards include turning circle, zig-zag and **full astern stopping tests**. When trials are conducted in condition other than full load, manoeuvring characteristics should be predicted for trial and full load conditions using a reliable method (i.e. model tests or reliable computer simulation) that ensures satisfactory extrapolation of trial

results to the full load condition. Unfortunately this is still neglected by many shipyards and **class societies**.

Full astern stopping test, crash stop – Full astern stopping test determines the distance along the path described by the midship of a ship measured from the position at which an order for full astern is given to the position at which the ship stops.

Crash-stops from full speed are nautically not sensible as turning usually offers better avoidance strategies involving shorter distances. Therefore stopping manoeuvres are recommended at low speed, because then the manoeuvre is of practical interest for navigation purposes.

Single-screw ships with propellers turning right will turn to starboard in a stopping manoeuvre. Since according to international nautical conventions, collision avoidance manoeuvres should be executed with starboard evasion, single-screw ships should be equipped with right-turning fixed-pitch propellers or left-turning CPPs.

Man-overboard manoeuvre (Williamson turn) – The manoeuvre used to search for a man overboard. It brings the ship on opposite heading and the same track as at the beginning of the manoeuvre. The rudder is laid initially hard starboard, then at e.g. 60° (relative to the initial heading) it is laid hard port, and at, e.g. -130° to midship position again. The appropriate angles (60° and -130°) vary with each ship and loading condition and have to be determined individually so at the end of the manoeuvre the deviation in heading is approximately 180° and in track approximately zero.

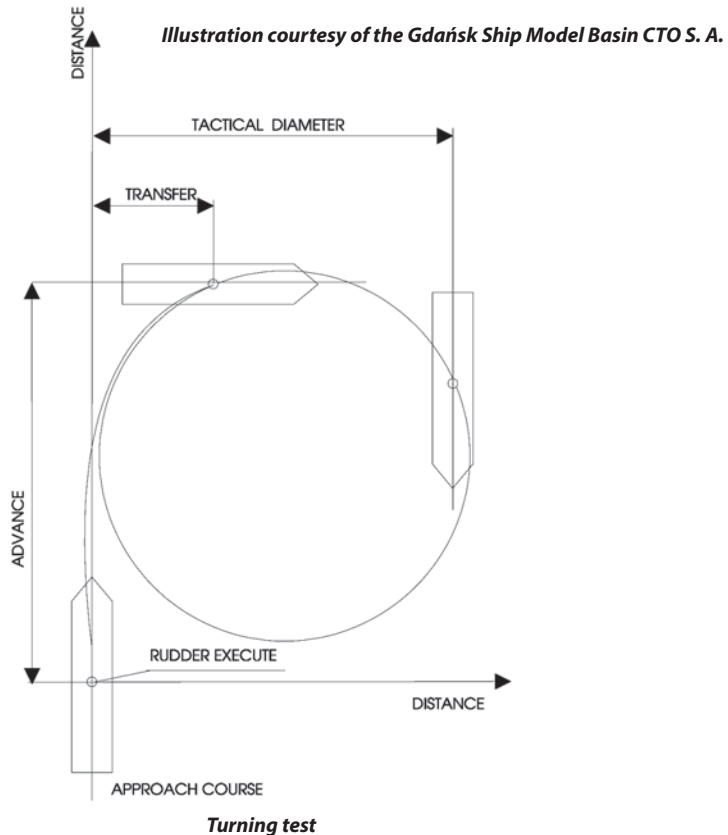

Pull-out manoeuvre – After a turning circle with steady rate of turn the rudder is returned to midship. If the ship is yaw stable, the rate of turn will decay to zero for turns both port and starboard. If the ship is yaw unstable, the rate of turn will reduce to some residual rate of turn. The pull-out manoeuvre is a simple test to give a quick indication of a ship yaw stability, however requires very calm weather.

Turning circle manoeuvre – Starting from straight motion at the test speed, the rudder is turned to 35° or the maximum rudder angle permissible and kept at this angle, until the ship has performed a turning circle of at least 540° . The trial is performed for both starboard and port side. The main information obtained from this manoeuvre consists of tactical diameter, maximum advance, transfer at 90° change of heading, times to change heading 90° and 180° , transfer loss of steady speed.

Zig-zag test – $10^\circ/10^\circ$ zig-zag test is the manoeuvre where a known amount of helm (10°) to either side when a known heading deviation (10°) from the original heading is reached. The test yields initial turning time, yaw checking time and overshoot angle.

After a steady approach the rudder is put over to starboard (first execute). When the heading is 10° off the initial course, the rudder is reversed to the same rudder angle to port (second execute). After counter rudder has been applied, the ship continues turning in the original direction (overshoot) with decreasing turning speed until the yaw motion changes direction. In response to the rudder, the ship turns to port. When the heading is 10° off the initial course, the rudder is reversed again to starboard (third execute). This process continues until a total of, e.g., five rudder executes have been completed.

$20^\circ/20^\circ$ zig-zag test is performed using the same procedure with 20° rudder angles and 20° change of heading.

Further readings: Resolution MSC.137(76) **Standards for Ship Manoeuvrability, Circular MSC/Circ.1053 Explanatory Notes to the Standards for Ship Manoeuvrability**. ABS Guide for “Vessel Maneuverability” (2006), can be downloaded from www.eagle.org

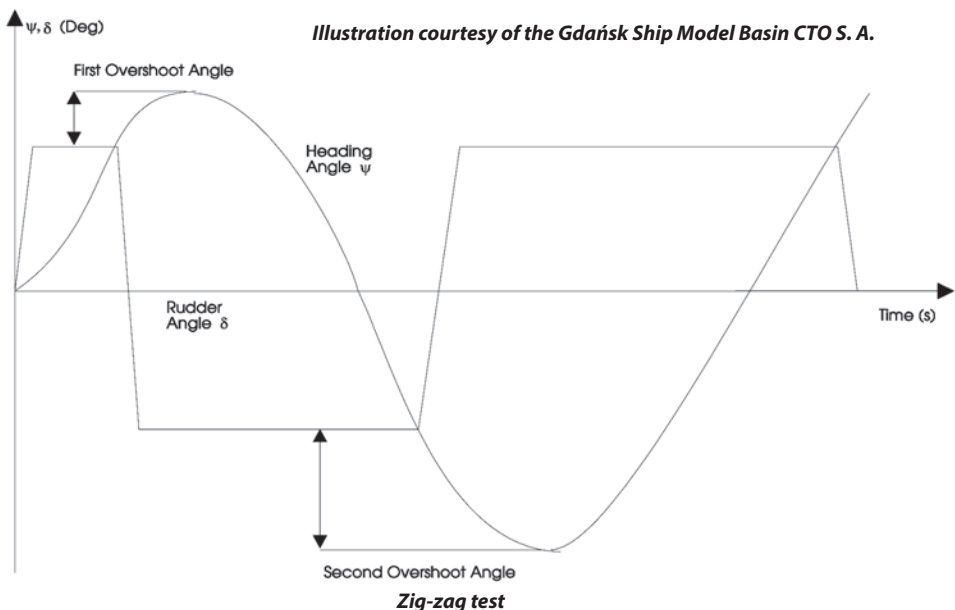

Manoeuvring stations – **Forecastle**, stern, pilot boarding station, muster stations.

Margin line – A line drawn at least 76mm below the upper surface of the **bulkhead deck** at side, (**SOLAS**). The margin line is a line defining the highest permissible location on the side of the vessel of any damage waterplane in the final condition of sinkage, trim and heel.

Margin plate – The outboard strake of the inner bottom.

MARIN – The Maritime Research Institute Netherlands was founded in 1929 as the Netherlands Ship Model Basin (NSMB) by the Dutch government and industry. The work was started in 1932, following completion of the deep water towing tank.

To cope with the ever-increasing demands of the industry for research in the fields of powering performance, seakeeping and manoeuvring, including shallow water effects, **cavitation**, **vibration**, noise, etc., a whole series of special test laboratories was successively built (Deep Water Towing Tank 1951, Shallow Water Basin 1958, High Speed Basin 1965, Depressurised Towing Tank 1972, Cavitation tunnel 1979. A new Seakeeping and Manoeuvring Basin became operational in the course of 1999. The upgrading of the Depressurised Towing Tank was completed in 2001.

As offshore technology experienced extensive growth, MARIN has become involved in offshore projects since 1960. A Wave and Current Basin was built in 1973, it was replaced by a complete new Offshore Basin in 2000.

As early as 1970, MARIN extended its activities to include nautical research and training. For this purpose, a modern Vessel Traffic Simulator and two full-mission simulators are available today.

At present, approximately 240 people work at MARIN; together they are responsible for a yearly turnover of € 24 million. 85% of it earned on the commercial worldwide maritime market.

For more information visit www.marin.nl

MARIN ARK – THE EVACUATION SYSTEM FROM RFD

Marine evacuation systems (MES) are provided for the high-speed evacuation of a large number of passengers and crew. These systems are based on slide or chute methods. They are used in association with large liferafts racked close to the position of the rigged slide.

RFD's Marin-Ark is claimed to be possibly the most revolutionary development in marine safety equipment to emerge during the 1990s. It is the first evacuation system to comply fully with the latest **SOLAS** Chapter III regulations governing safety on board passenger vessels. The history behind the development of Marin-Ark stems from recent tragedies at sea, such as the ESTONIA disaster in 1994, when 900 lives were lost in the Baltic, partly because many liferafts had been deployed upside down.

The system comprises two, three or four 106/109 person totally reversible rafts and two fully-enclosed telescopic descent chutes, all housed within one compact and lightweight stowage unit. Additional safety features include six separate buoyancy chambers, as compared to the two found in most ordinary **liferafts**. This is combined with a self-bailing capacity and a unique shape, which should ensure high stability even in rough conditions.

Fully-enclosed chutes ensure rapid and safe descent, whilst protecting evacuees from the marine environment. A unique telescopic design compensates for ship and sea motion and ensures that the chute is continuously useable in heavy weather. These innovative design measures should therefore guarantee a totally-enclosed, dry-shod evacuation.

The Marin-Ark system may be supplied for installation on an open deck, or in a tweendeck space. The system is fully operational and ready to receive the first evacuees within 90



Photo courtesy of RDF Beaufort

Marin Ark 430



Picture courtesy of Northern Shipyard Gdańsk

seconds of deployment, with the capability of evacuating 430 persons for each station well within the 30-minute timescale allowed.

Hydraulic cylinders activated by compressed nitrogen operate the system. The cylinders push the stowage out from its housing until it reaches an outer limit and tilts over, dropping the Marin-Ark liferafts into the water. When the liferafts leave the stowage, inflation starts automatically. Simultaneously, the chutes unfold behind liferafts. When the liferafts are fully inflated and correctly bowsed, the captain orders the evacuation.

Marine evacuation systems (MES) – MES is an appliance for the rapid transfer of persons from the embarkation deck of a ship to a floating survival craft. Escape systems are based on slide or chute methods. Slide systems consist of a gas-inflated slide and an inflated boarding platform. They are used in association with large **liferrafts** racked close to the position of the rigged slide. Difficult for use with excessive list of ship. See also **MARIN ARK, VIKING EVACUATION MINI CHUTE** and **VIKING MARINE EVACUATION SYSTEM**.

Dry shod marine rapid evacuation system – The system developed by Dunlop-Beaufort Ltd., suitable for high freeboard vessels. The design comprises a tubular chute with a flame retardant cover connected to an inflatable platform at its base from which the liferafts are boarded. The fully-enclosed chute ensures that passengers are not exposed to outside elements. The chute and platform is housed in a unit on deck.

Rigid evacuation slide – Marine Safety of Norway has introduced a rigid evacuation slide designed for high-speed crafts. The hydraulically-actuated slide comes in up to five sections and can be used for evacuating passengers from up to 9 m above sea level. The slide can be directly mounted to an escape door and comes with a hand pump for the hydraulic actuation in the event of a power failure.

Twin-track-slide marine evacuation system – The system comprises inflatable twin-track slides capable of evacuating passengers into two 135-person capacity liferafts which are connected to the slide. The separately-stored third raft gives the required capacity and is reached via one of the other rafts.

Vertical escape chute system – The system pioneered by Selantic Safety AS. Raft deployment is done simply by pressing the button either on the bridge or at an MES station, with all rafts inflating automatically. Weight is only 1000 kg for each station, or approximately one-third that of twin-track slides. In addition far less ship space is required compared with slides, the service costs are low, and the system is stable and dependable in high waves and winds.

Useful websites: www.VIKING-life.com ; www.liferaftsystems.com.au

Marine fuel oils – Heavy residual fuel oils (HFO) are used in the majority of motor ships. International standard ISO 8217 gives 12 classifications for residual oils and four classifications for distillate fuels.

Marine riser – A large diameter tube, which extends from the **blowout preventer** on the seabed, to the drilling platform. It is used as a return path for the drilling fluid.

Maritime Safety Committee (MSC) – The most senior of the technical committees of the **International Maritime Organization**.

Maritime industrial Organizations – A variety of Shipowners associations, trade unions and insurance companies such as:

Baltic International Maritime Council (BIMCO), www.bimco.dk

International Association of Dry Cargo Shipowners (INTERCARGO),
www.intercargo.org

International Association of Independent Tankers Owners (INTERTANKO),

International Chamber of Shipping (ICS), www.marisec.org

International Shipping Federation (ISF), www.marisec.org

P & I Clubs

Society of Gas as Marine Fuel (SGMF)

Society of International Gas Tankers and Terminal Operators (SIGTTO),

www.sigtto.org

VIKING MARINE EVACUATION SYSTEM

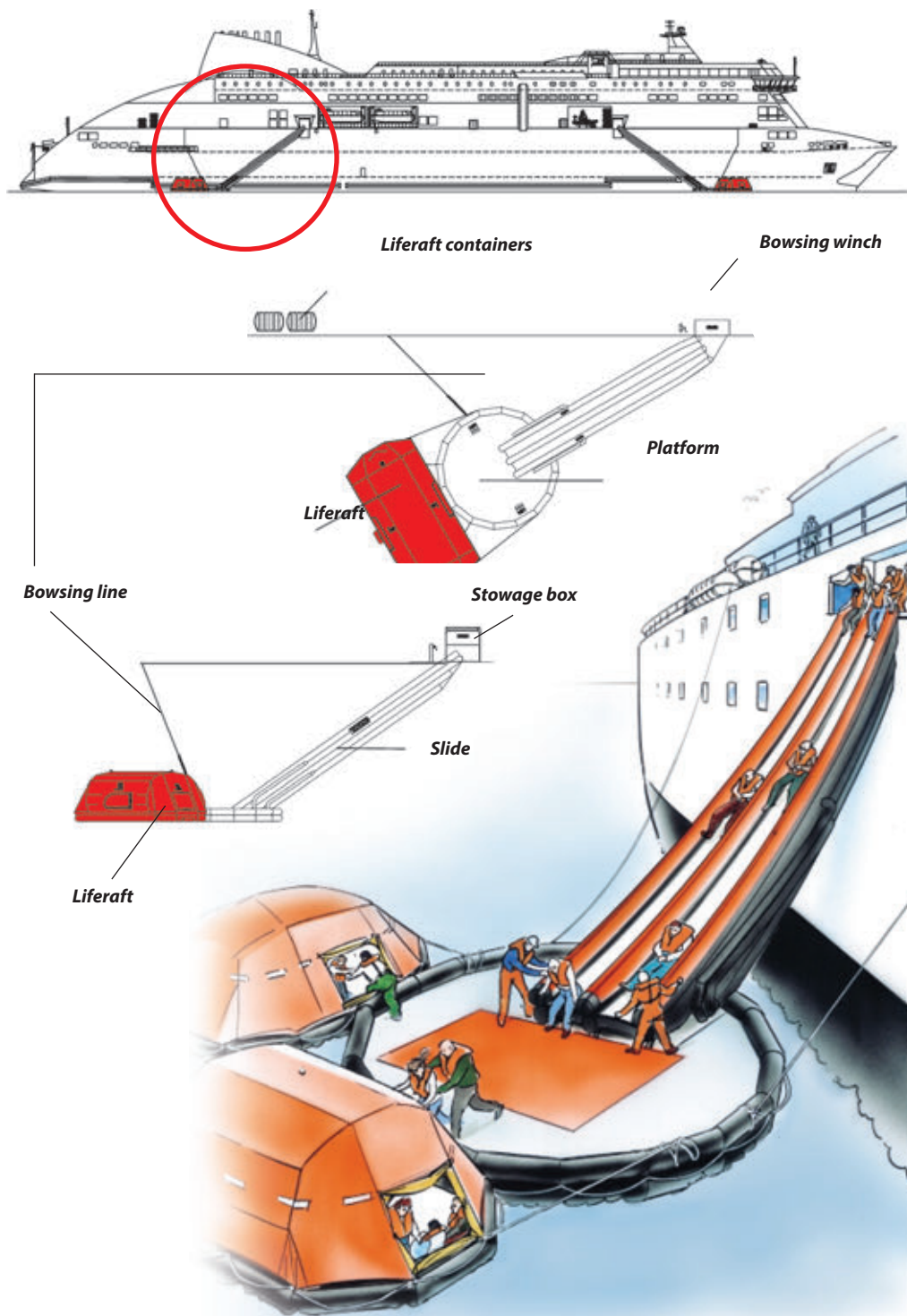

Maritime inquiry – An inquiry conducted by maritime and legal authorities following an accident or near-accident at sea, resulting in a maritime declaration. The purpose of such hearings is to discover the cause of accident or mishap. The inquiry is primarily conducted among members of crew, but may also involve bystanders who may shed light in the events.

Maritime safety information – Navigational and meteorological warnings, meteorological forecasts and other urgent safety-related messages broadcast to ships, (SOLAS, Chapter IV).

Mark III system - Technigaz Mark III **LNG cargo containment system** incorporates a 1.2mm-thick waffled 304L stainless steel **membrane** supported by load-bearing insulation. Stresses in the membrane (due to combined thermal **shrinkage**, static and dynamic effects of the cargo and hull girder bending) are virtually eliminated thanks to its ability to expand and contract. A plain fibre-reinforced polyurethane is used for the insulation layer and a triplex aluminium foil, glued with glass cloth on both sides, forms the **secondary barrier**. Mastic behind the insulation panels uniformly distributes loads to the inner hull structure.

MARPOL 73/78 – The MARPOL Convention is the main international convention covering prevention of pollution of the marine environment by ships from operational or accidental causes. It is a combination of two treaties adopted in 1973 and 1978 respectively, and updated by amendments through the years.

The International Convention for the Prevention of Pollution from Ships (MARPOL) was adopted on 2 November 1973 at IMO and covered pollution by oil, chemicals, and harmful substances in packaged form, sewage and garbage. The Protocol of 1978 relating to the 1973 International Convention for the Prevention of Pollution from Ships (1978 MARPOL Protocol) was adopted at the Conference on Tanker Safety and Pollution Prevention in February 1978 held in response to a spate of tanker accidents in 1976 -1977.

The combined instrument is referred to as the International Convention for the Prevention of Marine Pollution from Ships, 1973, as modified by the Protocol of 1978 relating thereto (MARPOL 73/78), and it entered into force on 2 October 1983 (Annexes I and II).

The Convention includes regulations aimed at preventing and minimising pollution from ships – both accidental pollution and that from routine operations – and currently includes six stand-alone Annexes dealing with pollution by different substances.

MARPOL 73/78 Annex I – Regulations for the Prevention of Pollution by Oil – Annex I (Oil) came into force on 02.10.1983 and contains conditions for discharge of mixtures containing oil and also requirements applicable to the construction and equipment of tankers larger than 150GRT and other ships larger than 400GRT. This Annex is based on the principle that oil and water do not mix and are therefore easily separated. It contains requirements regarding the operation, construction and equipment of ships. The operational requirements stipulate the conditions under which ships may discharge water/oil mixtures into the sea. Overboard discharges are to be above the **waterline** so that discharges can be visible. The construction and equipment requirements are such as to enable the ship personnel to comply with the discharge conditions. Other construction requirements are such to minimise the chances of oil cargo tank penetration in the event of damage, i.e. double hull construction and protective location of segregated ballast tanks. Requirements for minimising oil pollution from oil tankers in the event of side and/or bottom damages penetrating the cargo oil tanks are also included.

MARPOL 73/78 Annex II – Regulations for the Control of Pollution by Noxious Liquid Substances in Bulk – Annex II came into force on 06.04.1987 and contains discharge conditions for four categories of noxious substances and requirements applicable to the construction and equipment of ships carrying such substances. Unlike oil, most chemicals or noxious liquids will mix with water and are not easily separated from it. The main principle of Annex II is to dilute cargo residues in seawater to prescribed limits depending on their pollution hazard and facilitate the distribution of discharges by utilising the wake of the ship. The discharges are required to be made below the water line and in such a way that the water/residue mixture is retained in the ship boundary layer and carried aft when en route to be distributed by the wake astern.

MARPOL 73/78 Annex III – Prevention of Pollution by Harmful Substances Carried by Sea in Packaged Form – Roughly 15% of goods carried as cargo are **dangerous goods**. Annex III which came into force on 01.07.1992 contains requirements for safe handling of packaged substances that represent a serious risk to the environment, as well as guidelines for identification of harmful substances.

MARPOL 73/78 Annex IV – Prevention of Pollution by Sewage from Ships – The regulations contain requirements for surveys and certification of sewage systems and impose operational restrictions regarding sewage discharge. Annex IV entered into force on the 27 September 2003.

MARPOL 73/78 Annex V – Prevention of Pollution by Garbage from Ships – Annex V, which came into force on 31.12.1988, contains requirements relating to the disposal of all types of food, household and operational waste that have accumulated aboard ships during operation.

MARPOL 73/78 Annex VI – Prevention of Air Pollution from Ships – Annex VI, which came into force on 19 May 2005, governs the control of the discharge of noxious substances from ship diesels. It is applicable to ship diesels with a power larger than 130kW built and installed since 1 st January 2000. The regulations limit discharges into the atmosphere of **volatile organic compounds** from tanker cargoes, sulphur oxide (**SOx**) from the combustion of fuel oils and **nitrogen oxide** (NOx) from diesel engines. With regard to **ozone depleting substances**, deliberate discharge is prohibited. New installations, which contain ozone-depleting substances, are prohibited on all ships.

MARSEC – MARSEC means Maritime Security as used by the U.S. Coast Guard to designate security levels.

MARVS – The maximum allowable relief valve setting of a cargo tank, (**IGC Code**).

Mass disease – An illness preferably of an infectious nature affecting more than two persons on board at the same time.

Mast – A tubular steel erection, which carries various items of navigational equipment and fittings, e.g. lights, radar, etc.

Master controller – A controller, which is used in a cascade control system. It provides an output which acts as a variable desired value for a slave controller.

Maximum allowable working pressure of a piping system – The maximum pressure of a piping system determined, in general, by the weakest piping component in the system or by the relief valve setting. The maximum allowable working pressure is not to exceed the **design pressure**.

Maximum ahead service speed – The greatest speed the ship is designed to maintain in service at sea at the deepest seagoing draught, (acc. to **SOLAS**, Chapter II-1, Part A).

Maximum astern speed – The speed, which is estimated the ship can attain at the designed maximum astern power at the deepest seagoing **draught**, (acc. to **SOLAS**, Chapter II-1, Part A).

Maximum continuous rating (MCR) of engine – The maximum continuous rated power output as specified on the nameplate and in the Technical File of the marine diesel engine.

Mayday – A radio distress call.

MCF – A measure of volume denoting one thousand cubic feet of natural gas equal to 28.3168 cubic metres.

Mean time between failures – The ratio of the accumulated operating time for a sample of parts to the total number of failures in the sample, for specified conditions of operation.

Means of rescue (MOR) – Means for rapidly recovering survivors from water and transferring them from rescue units or survival craft to the ship, (mandatory for each **ro-ro** passenger ship).

AB Welin's MOR system – The system is based on a floating rigid rescue platform which is suspended by four individual wire falls from a pair of davit arms mounted on a deck above. The four wire falls increase stability and safety and eliminate the risk of platform rotation. The MOR, made of sea resistant aluminium, is equipped with handrails, protection nets, and two boarding ramps. The system is ready for immediate use all the time and can be deployed in less than one minute by one crewmember. In a rescue operation, the self-draining platform is lowered to water level where it can be loaded with people from the water, a small boat or from a rescue craft. The loaded platform is then hoisted to the deck level where the people are transferred to the vessel.

Mechanical efficiency – The ratio of shaft power to the indicated power of an **internal combustion engine**.

Mechanical seal – A shaft sealing arrangement fitted to pumps in place of a **stuffing box** and gland packing assembly.

Medium-speed engine – An **internal combustion engine** operating within the range from 250 rev/min to about 1200 rev/min.

Melting – The process of changing a solid into liquid.

Membrane BioReactor (MBR) - Wärtsilä Hamworthy's MBR technology is an advanced wastewater treatment process based on biological degradation and membrane separation. It delivers the highest quality discharge without requiring any addition or generation of chemicals hazardous to the maritime or shipboard environment.

Black and grey water passes through the automatic screen press into the first stage bioreactor where the active biomass degrades organic material. The active biomass is pumped through an interstage filter fitted with fine mesh. The filtered biomass, free of any fibrous materials, is returned into the second stage bioreactor. Biomass is circulated through membrane modules to produce a trans-membrane pressure and scouring velocity. Clean permeate is taken from the membrane modules. The concentrated biomass is returned to the second stage bioreactor for discharge. See also **Sewage treatment**.

Membrane containment system of HANJIN MUSCAT

Built in 1999 by Hanjin Heavy Industries Co Ltd, Korea, **LNG tanker** HANJIN MUSCAT has four **cargo tanks** contained in a complete double-hull structure, which includes ship sides and **bottom**, transverse **bulkheads** and upper deck trunk. This double structure not only protects the tanks from external damage, but also insulates the outer hull against critical steelwork fractures caused by the low temperature (-163°C) at which cargoes are carried.

Membrane technology

The cargo containment system is a No 96-2 design from Gaz Transport & Technigaz (GTT). The insulation is formed by primary and secondary membranes of 0.70mm Invar sheets (a product containing 36% nickel steel) in conjunction with expanded Perlite beads contained in plywood boxes which are attached to the inner hull by stud bolts. This combination is able to sustain the liquid pressure and static and dynamic loads, and to limit the daily **boil-off rate** to 0.15% of cargo volume.

Illustration courtesy of Wärtsilä Corporation

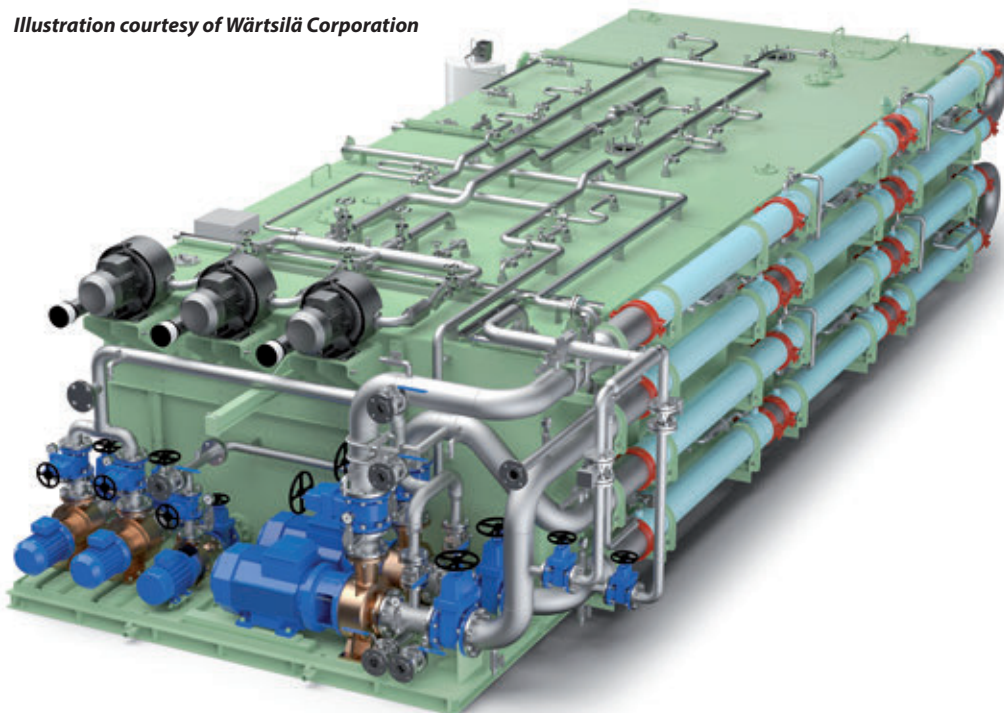

Membrane BioReactor (MBR)

Membrane technology – The membrane technology was developed by the naval engineering firms Gaz Transport and S.N. Technigaz for the transport of liquid methane by sea. The main feature of this technology are **membrane tanks**; non-self-supporting tanks consisting of a thin wall (membrane), supported through a layer of insulation by the adjoining hull. The membrane provides cargo containment and the insulating material transmits loads resulting from the cargo to the ship structure.

Membrane-type LNG cargo containment system – Membrane systems exploit the double hull of the ship as the supporting structure on which a cryogenic liner – performing the two functions of gas tightness and thermal insulation – is applied. The gas/liquid retention role against methane leakage is effected by a thin (from 0.7mm to 1.2mm thick) sheet of Invar steel or waffled stainless steel, termed the **primary membrane**.

A fully redundant secondary membrane layer provided in case of failure of the primary barrier is constructed of either Invar steel or a glass fabric-aluminium composite material called Triplex. The insulation function for transportation LNG at -160°C is performed by plywood boxes filled with perlite or by reinforced polyurethane foam fabricated into panels. See also **Mark III system**.

Membrane type Nitrogen Generator System

Built in Japan at the Namura yard, the **methanol carrier MILLENNIUM EXPLORER** is equipped with the world largest ship-based nitrogen generator system. Designed by Permea Maritime Protection, the system is based on membrane technology, utilizing patented PRISM[®] membrane hollow fibres. The nitrogen is used to protect the methanol cargo during sea voyages as well as during cargo discharge operations.

With a rated capacity of 6250 m³/h, the nitrogen generator is about three times bigger than the previous largest one delivered by Permea. The system can produce 95% nitrogen purity and comprises feed-air compressors, a valve and control skid, a pre-treatment skid, and membrane skids.

Within the system, there are six oil-lubricated, water-cooled screw type feed-air compressors, supplied by Tamrotor of Finland, each with a 3-phase 363kW/440V motor. The compressors weight 4700kg each, measure 3100 x 1700 x 2200mm, and have been equipped with a special canopy to reduce the noise level down to approximately 80DbA.

Two compressed air filters, manufactured by Parker Hanifine, incorporate three filters in series, and each unit provides 50% of the system capacity. Elmess of Germany has supplied the two 40kW rated, stainless steel heaters for the compressed air units. The control system for the generator was manufactured by Permea in Norway, while the six membrane skids, each with a capacity of approximately 1065 m³/h of nitrogen were produced by Air Products in USA. The entire system was assembled and delivered from Parma's plant in Kristiansand, Norway.

The nitrogen produced by PRISM[®] systems is extremely dry, with dew points down to -70°C. When used for inert purging and blanketing of chemicals or other cargo, it does not only minimise the risk of explosion and fire, but also prevents degradation of cargo sensitive to oxygen, moisture or combustion by-products. Furthermore, with an ample onboard supply available, nitrogen can be used more extensively, without regard to cylinder supply. One example of such extended use is the purging of cargo lines between pumping of different cargoes, which, often at the expense of safety, is still frequently done with air. Super-dry nitrogen is also ideal as non-freezing, non-corrosive instrument gas, and for drying of void spaces like cofferdams, etc.

Memorandum of Understanding on Port State Control (MOU) – Agreements on port state control signed in several regions of the world by the coastal states; 1982 Paris MOU for the European region, 1992 Latin America agreement, 1993 Tokyo MOU for the East Asia region, etc.

Mermaid propulsion unit – The Rolls-Royce's podded propulsor developed by Kamewa and Alstom and available from 5 to 25MW. The Mermaid[™] hydrodynamically optimized outboard part is 360 degrees rotatable, or +/- 35 degrees hardover/hardover in transit, by a hydraulically operated **steering gear**. The synchronous type motor with brushless excitation has stator shrink fit into the pod housing in order to decrease pod diameter and maximize cooling effect from surrounding sea-water. Additional cooling is arranged by circulating air in a completely sealed circuit, with redundant water coolers and fans located in the pod room.

The Kamewa fixed pitch propeller can be either solid or with bolted blades. Mermaids are designed for underwater mounting/dismounting and supported by facilities allowing propeller and shaft sealing system replacement underwater.

The first Mermaid propulsors were installed onboard the 1950 passenger-capacity cruise vessel MILLENNIUM which was delivered by Chantiers de l'Atlantique to Celebrity Cruises.

The propulsion system comprises two Mermaid pod drives with power supplied by low emission gas turbine power plant. Each of the pod propulsors is rated at 19.5 MW and swings a 5.75m-diameter fixed pitch propeller.

The QUEEN MARY 2 has four Rolls Royce Mermaid podded propulsion systems, the first four-podded installation to date and the largest output for any podded-driven vessel. The system comprises two fixed and two azimuthing pod units delivering a combined output of more than 85 MW, which gives the ship a service speed of 30 kts.

See also **Electric podded propulsors**.

Messenger line – A light line attached to the end of a main **mooring line** and used to assist in heaving the mooring to the shore or to another ship.

Messroom – Dining room for officers or **crew**.

Metacentre M (initial transverse metacentre) – When a ship floating at rest in still water is inclined by an external force to a small angle ϕ , the **centre of buoyancy** shifts from B to the new position – B_f . The point where the new line of **buoyancy** force intersects the initial line is denoted as the initial metacentre M. For practical purposes, in normal merchant ships the point M does not change in position for inclination up to about 7-15 degrees.

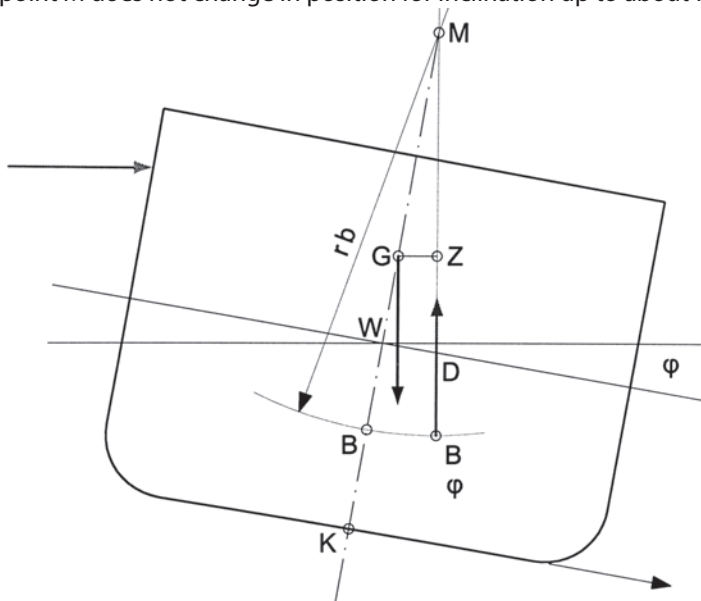

Initial transverse Metacentre M

KM – The height of the initial metacentre M above the base plane. It depends on a geometrical form of ship's submerged part.

$$\mathbf{KM} = \mathbf{KB} + \mathbf{BM}$$

where:

KB – The height of the centre of buoyancy above the base plane denoted as vertical centre of buoyancy (VCB),

BM – Metacentric radius = Moment of inertia of the waterplane/Volume of **displacement** = I/V .

GM – The vertical distance between G and M is referred to as the metacentric height.

Metacentric height

Metacentric height – The vertical distance between G and M is referred to as the metacentric height. The relative positions of vertical centre of gravity G and the initial metacentre M are extremely important with regard to their effect on the ship's stability. The ship is in stable equilibrium if G is below M, in neutral equilibrium if VCG and M are coincident and in unstable equilibrium if VCG is above M. If the metacentric height of a ship is small, the righting arms that develop will be small. Such a ship is "tender" and will roll slowly. However, if the metacentric height (GM) of a ship is large, the righting arms that develop, at small angles of heel, will be large. Such a ship is "stiff" and will resist roll.

It is advisable to avoid excessive values of metacentric height, since these might lead to acceleration forces which could be dangerous to the ship, its equipment and cargo.

The metacentric height can become negative if the **centre of gravity** is too high. Even with negative metacentric height, ships with certain forms can still find a position of stable equilibrium at an angle of heel called angle of loll. The angle of loll should be corrected only by lowering the gravity center. The moving masses transversally can endanger the ship.

Methane hydrate – Methane hydrate is a cage-like lattice of ice inside of which are trapped molecules of methane, the chief constituent of natural gas. If methane hydrate is either warmed or depressurized, it will revert back to water and natural gas. While global estimates vary considerably, the energy content of methane occurring in hydrate form is immense, possibly exceeding the combined energy content of all other known fossil fuels.

Methanol carrier MILLENNIUM EXPLORER

According to **The Motor Ship April 2000**

The double-hulled methanol carrier MILLENNIUM EXPLORER has twice the capacity of any other vessel of its type. Total cargo capacity is around 120,000m³. Methanol is transported in 12 cargo tanks. All of them have been coated with an environmentally-friendly, inorganic zinc silicate paint system. All tanks are fitted with two pressure-vacuum valves to comply with regulations requiring a secondary means of releasing pressure build-up in emergency situations.

Cargo handling operations revolve around two steam-driven cargo pumps. Each pump can operate at a capacity of 2500 m³/h. Three 500mm-diameter cargo lines have been installed onboard, to allow for cargo segregation should this be required.

One of the most significant features of MILLENNIUM EXPLORER is the installation of the world largest ship-based **membrane type nitrogen generator** system. The nitrogen is used to protect the methanol cargo during the sea voyage as well as during cargo discharge operations. Other notable items of equipment include a 3000 m³/h motor-driven ballast water pump and a powerful cargo stripping/tank washing system. Considerable attention has been paid to ensure that the stripping system onboard is extremely effective, thus minimising the residue left behind to no more than 30 litres per tank.

The main engine Wärtsilä 7RTA58T has a maximum output of 14,004kW at 103 rev/min. It provides a service speed of about 15.4 knots at 15% sea margin, at the draught of 14.297m. The engine drives a 7.4m-diameter FP propeller. This features a **propeller boss cap fin** designed to reduce fuel consumption up to 5%.

Length, oa: 240.99m, Length, bp: 232.00m, Breadth, mld: 42.00m, Depth, mld: 21.20m, Deadweight: 100,063dwt, Draught, design/scantling:12.19/14.27m, Cargo capacity:

120,000m³, Nitrogen generator: 6250 m³/h, Service speed:15.4 knots, Main engine output: 14,004kW at 103 rev/min, Complement: 30.

Mevis duct – see **POWER-SAVING DEVICES**.

Mezzanine decks – Lightweight, movable decks used on fast ferries. If traffic is freight dominated, the crew can hydraulically raise the mezzanine deck up to the deckhead to allow clearance for high freight vehicles. It is secured to the deckhead by locking devices. If only cars, or a mix of cars and light freight, are being carried the mezzanine can be left in the lowered position.

Midship section –

1. The cross section through the ship, midway between the forward and after perpendiculars.
2. A drawing showing standard cross sections of the hull at, or near amidships, and presenting the scantlings of the principal structural members.

Midship section modulus – The section modulus of a transverse section of a hull girder amidships, evaluated by taking into account the longitudinally effective material.

Mill scale – An oxide of iron which appears on the metal surface during manufacture. It is usually removed by suitable surface treatment prior to priming and painting.

Miller timing – In Wärtsilä engines the inlet valves close just before the piston reaches the bottom dead centre. This method, called “Miller timing”, reduces the work of compression and the combustion temperature, which results in higher engine efficiency and lower emissions.

Mimic diagram – A line diagram of a pipe system or items of equipment which includes miniature alarm lights or operating buttons for the relevant point or item in the system.

Minimum breaking load of a mooring line (MBL) – The minimum breaking load of a **mooring line** as declared by the manufacturer for a new line.

Minimum comfortable condition of habitability – A condition in which at least services such as cooking, heating, domestic refrigeration, mechanical ventilation, sanitary and fresh water are adequately provided.

Minor failure of tanker – Local fracture of a tank boundary weld.

Misalignment – The distance between the axes of two shafts to be coupled together.

Mitsubishi Stator Fin – A device aimed primarily at improving propulsive performance. It consists of fixed-type steel fins at the rear of the propeller which are fitted onto the forward side of the rudder horn. As the propeller revolves, it introduces a rotary component into a race, which the Stator Fin turns into an additional propulsion force. Propulsive performance, construction, and strength have been tested during sea trials of **ro-ro** ship TRANS FUTURE 3 (Significant Ships of 2001).

Mixed stowage – A system to stow 20-foot containers into 40-foot cell guides. Starting from tank top you can stow from 1 to 4 tiers 20-foot containers (only secured by single stacking cones) and top them up with at least one 40-foot container. The stackweight of the 20-foot containers is to be reduced to about 60 tons. See also **Anti-Rack Spacer stowage system** and **Side support stowage system**.

MMBTU – One million British Thermal Units. BTU is a traditional unit of energy equal to 1055.06 joules. It is the amount of energy needed to cool or heat one pound of water one degree Fahrenheit.

MMSCFD – Million standard cubic feet per day is a unit of measurement mainly used in the USA. Mainly used as a measure for natural gas. One MMSCFD equals 1180 m³/h.

MOB RETRIEVAL EQUIPMENT – There are several types of man overboard retrieval equipment like ladders, scrambling nets, A-frames, Jason's cradle, hydraulically operated platforms, etc. Whatever means of recovery is fitted, it should be both effective and simple to operate in all weather conditions. The system should be adapted for easy rescue of a weak or unconscious person.

Lifting survivors is preferable to having them climb a ladder or net. People who have been in the water, the injured and the incapable, should be lifted in horizontal or near-horizontal position if possible. This minimizes the risk of shock induced by sudden transfer from the water and possible hypothermia. Vertical rescue in a single loop device is highly risky and should be avoided where possible.

Further reading: MSC.1/Cir.1182 *Guide to Recovery Techniques*

Cosalt Personnel Recovery Device (PRD) – A new safety equipment for man overboard retrieval situations. The device allows for conscious or unconscious casualties to be lifted from water in a safe horizontal position. The Cosalt PRD has plastic rungs and steel rods and is fitted with stainless steel snap hooks. Lifting strops and heaving lines are attached to aid retrieval. The PRD comes in a rescue stretcher configuration, to be used with block and tackle or davit arrangements. The PRD can also be used as a scramble net over the side of a vessel.

Dacon Rescue Frame – Approved by NMD - Conforms to the 1997 UKOOA guidelines for Standby vessels the Dacon Rescue Frame is a manual rescue "net" for use on rescue craft for gentle and effective recovery of exhausted and seriously injured persons from water. The equipment simplifies recovery and is quick and easy to handle for rescue personnel. The Dacon Rescue Frame is simple to use and requires only a brief introduction. The Dacon Rescue Frame is designed for use on any craft where the freeboard height makes it difficult to recover a person from the water.

Dacon Rescue Scoop is a powered rescue system for recovery of casualties from the water directly on board larger rescue vessels. The Dacon Scoop is a semi-rigid, manoeuvrable rescue net which is operated by a standard deck crane. The net suspends from the ship's side providing an effective rescue reach of about 3 - 6 m, depending on dimensions and crane reach.

Double loop RLS – A new double loop rescue device developed at the University of Applied Science in Hildesheim, Germany, by Prof. M.Schwindt allows lifting a person out of water in seated position. It consists of two double beackets – a floating one that fits under the arms and a sinking one to support the legs. The loops are easy to apply to an unconscious victim by a rescue swimmer.

Rescue basket – Rescue basket usually takes the form of a metal frame with floats/fenders around its perimeter and the lifting hook made fast to the top of the frame, clear of people inside. The basket floats partially submerged, so that people can easily enter it or be pulled into it. The floats double as fenders during the lift, should the basket swing against the ship's side. Some baskets are designed to fold for ease of stowage.

Mobdock – A steel box (mobile mini drydock) provided with an access hatch and used as an external enclosure to carry out dry work to be done underwater.



Rescue lifting system with double loop and stopper block



Rescue star

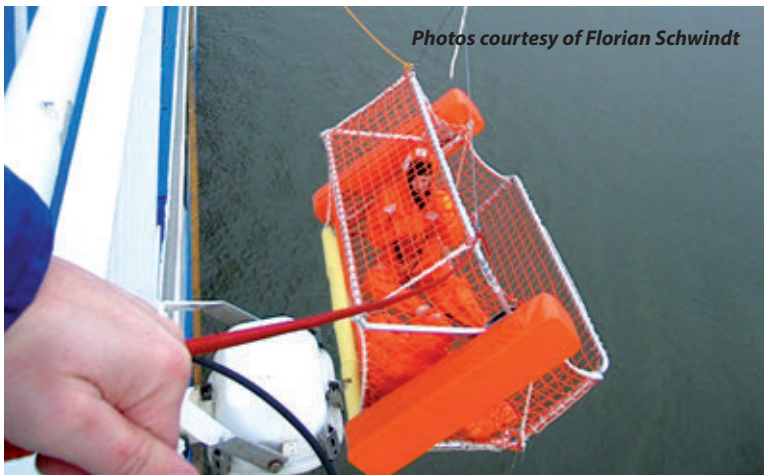

Photos courtesy of Florian Schwindt

Rescue basket

MOBILE OFFSHORE DRILLING UNIT (MODUs)

If geological predictions based on seismic surveys show that a particular offshore area offer promising prospects for finding oil, a well is drilled to examine these predictions. These drilling operations are carried out from a Mobile Offshore Drilling Unit (MODU). It can be jack-up, semi-submersible, barge-type or ship-shaped.

Drillship – A ship specially equipped to conduct drilling of oil wells at sea. The primary difference between a drillship and conventional vessel is the presence of a centre opening (moonpool) for conducting drilling operations. The principal requirement for the propulsion system of a drillship is the ability to hold the vessel at a fixed position over the drill hole, since in deeper water anchors cannot be used.

The first drill ship, CUSS-1, commenced drilling operations near Guadalupe Island off the coast of Mexico in early 1961. The ship was a converted naval barge that had been fitted with experimental deep-water drilling equipment and a dynamic positioning system. Compared to trading ships, drillships are designed to remain at sea for long periods, and the consequences of component or system failure are far greater than for most conventional ships.



The world's largest drilling ship STENA DRILLMAX, built by Samsung Heavy Industries in Korea has twin drilling derricks and is intended for oil and gas exploration in water up to 3000m. With a displacement of 97,000t, overall length of 228m and breadth of 42m, it is capable of drilling to a depth of 11,000m.

The power plant comprises six diesel-alternators. Each is made up of a 7680kW Wärtsilä 16V32 engine driving an alternator of 7000kW output. This package supplies current to six FP azimuthing thrusters for both propulsion and dynamic positioning.

The first of the new generation of deepwater drillships were based on tanker hulls, readily available to the shipyards. However, these fuller hulls would also demand more power for station keeping and transit. Focusing on this aspect, other designers sought to develop hulls of smaller dimensions and lower block coefficients than the tanker hullforms.

The new drillships are designed for operations around 10,000ft water depth, although the actual water depth capacity as-delivered varies depending on the length of on-board riser initially fitted. As a consequence, the new vessels are much larger than those of the previous generation. They have displacements in the range 40,000t to 100,000t, compared to the 18,000t typical of the previous generation. This explains large variable “deckload” capacities in the range from 15,000 to 25,000 tonnes, compared with the 6000t to 9000t of the earlier generation of ships.

To improve the efficiency, the new drillships are fitted with dual-activity rigs with two sets of drilling equipment such as mud pumps, drawworks, top drives and mud treatment systems. When a hole is drilled by the first drilling system, the second drilling system is used for making up casing and tubing strings in advance.

Jack-up – A Jack-up is a self-elevating offshore drilling unit that consists of a self-floating, flat box-type deck structure supporting the drilling rig, drilling equipment and accommodation. It stands on 3 or 4 vertical legs along which the platform can be self-elevated out of the water to a sufficient height to remain clear of the highest waves. Drilling operations take place in the



Photo courtesy of Maersk/Statoil

Jack-up MAERSK INSPIRE

Jack-up rigs are used for exploration, development and well servicing (workover) operations.

MOBILE OFFSHORE UNITS (MOUs)

elevated condition with the platform standing on the seabed. This type of drilling unit is used for drilling operations in water depths up to about 100m. Jack-ups spend part of their life as floating structures. This is when such units are towed to a new location by means of ocean-going tugs. In this mode, the legs are lifted up and extend upwards over the platform. On location the legs are lowered to the seabed and the hull is raised above the surface of the sea.

Semi-submersible drilling unit is a column-stabilised watercraft consisting of a main deck (Topside Deck Structure) connected to the underwater hull or footings by columns or caissons. The weight of columns is high and without sufficient buoyancy in themselves. Lower hulls or footings are normally provided at the bottom of the columns for additional buoyancy and the most common arrangement are either twin pontoons connected by braces or a ring (continuous) pontoon. Drilling equipment, mud systems, living quarters and so forth are placed on the main deck, and ballast tanks, thrusters, sea water pumps are arranged in the underwater hulls.



Photo courtesy of Stena Drilling

Semi-submersible drilling unit

Semi-submersible drilling units can be towed and anchored, or moved by and kept in position by their own thrusters using dynamic positioning.

Further reading: ABS publication "**Mobile Offshore Drilling Units (2006)**"; can be downloaded from www.eagle.org

MOBILE OFFSHORE UNITS (MOUs)

Mobile Offshore Units – Self-elevating or column-stabilized units, not fitted with drilling equipment, production facilities, hydrocarbon storage, or any other system onboard handling hydrocarbons. Examples of Mobile Offshore Units are:

- Accommodation Units

- Crane Units
- Construction and Maintenance Units
- Drilling Tenders
- Pipe and Cable Laying Units
- Wind Turbine Installation, Maintenance and Repair Units and similar units used by the offshore industry.

Accommodation Unit – A mobile offshore unit primarily intended for the accommodation of more than 36 persons who are industrial personnel, engaged in some aspect of offshore or related employment, excluding members of the crew. It is intended that during jacking or towing operations, a self-elevating unit will have on board only those crew members necessary for these operations.

Construction and Maintenance Unit – A mobile offshore unit primarily intended for construction and maintenance activities in support of offshore mineral exploration and production operations.

Crane Unit – A mobile offshore unit primarily intended for the lifting of heavy loads in oil drilling and production operations, offshore construction and/or salvage operations. See also **Crane vessel OLEG STRASHNOV**.

Drilling Tender – A mobile offshore unit primarily intended as support to an offshore drilling platform. It may contain the power supply, circulating pumps (connected to the platform by hoses) and storage tanks, drill pipe racks, casing, cement, storage space, living quarters and generally, helicopter landing platform.

Wind Turbine IMR Unit – A mobile offshore unit primarily intended for the installation, maintenance, and repair of wind turbines, including pile driving, tower installation, nacelle and blade installation. See also **Wind Turbine Installation Vessels**.

Further reading: ABS "Guide for Building and Classing Mobile Offshore Units" (2008), can be downloaded from www.eagle.org

Model testing tanks – Towing tanks, manoeuvring and seakeeping basins used to carry out experiments with models. See also **MARIN**.

Manoeuvring basin of UK Defence Evaluation and Research Agency (DERA)

A 120m x 60m x 5.5m concrete manoeuvring basin is used to test autonomous models without need of umbilical. It has wavemaking and rotating arm systems and the latter has a maximum test radius of 27.5m and a maximum speed equivalent of 60 km/h. The wavemaker is a 60m long wedge type in five sections and is capable of creating wave lengths of 1 to 12m.

Model towing tank of UK Defence Evaluation and Research Agency (DERA)

A 270m long, 12m wide and 5.5m deep wave creating a towing tank with deep and shallow docks. A planner motion mechanism can be utilised to measure the forces on a model travelling in a straight line or without superimposed yaw or pitch angles. The carriage can achieve a maximum speed of 12m/s and the wavemaker is the wet back, flat type, so capable of producing regular, random and/or rough sea breaking waves.

MODEL TESTS

The most comprehensive assessment of power requirements for a new ship is obtained by conducting experiments with a model hull and propeller in a towing tank. Traditional ship model tests provide still more accurate predictions of ship performance than existing



*The model of the MPV OSTSEE in the Gdańsk Ship Model Basin CTO S.A.
Hull shape designed by BOG-Projekt*

computational fluid dynamics (CFD) methods can deliver. Various tests are performed to evaluate **ship resistance**, propulsion, manoeuvring and **seakeeping** of all the types of hull forms. Test methodology, post-test analyses and extrapolation to full-scale are guided by ITTC Recommended Procedures; see **International Towing Tank Conference**.

In order to perform model tests for any ship, it is of course necessary to have a physical ship model to be towed. The model should be as large as possible to minimize viscosity scale effects. However the model can not be too large to avoid effects of restricted water in the test basin. The size of a stock propeller is to be taken into consideration when the scale for a ship model is selected. The material of which the model is made is not important provided the model is sufficiently rigid. Wood, wax, high density closed cell foam and fibre reinforced plastic are used. Models are normally cut from a plan re-drawn from the hull lines submitted for testing. However, building a ship model costs quite a lot, so to avoid waste of money an analysis of hull lines should be carried out first.

Model tests required for a full-scale performance prediction comprise the resistance test, the self-propulsion test and the propeller open-water test.

Resistance tests – These tests are conducted to provide data from which the resistance of the model, at any desired speed, may be determined. For this purpose the model is towed at speeds giving the same Froude number as for the full-scale ship, and the model resistance and its speed through the water are simultaneously measured. The running attitude of the model, i.e. sinkage fore and aft or the running trim and sinkage are usually measured.

Model should be tested in one or both of the following conditions:

1. Naked resistance of the model without any appendages to determine the resistance coefficients of the basic form.
2. Inclusive resistance of the model to determine the increase in resistance coefficients due to appendages.

MODEL TESTS



Preparing model for tests



Resistance test

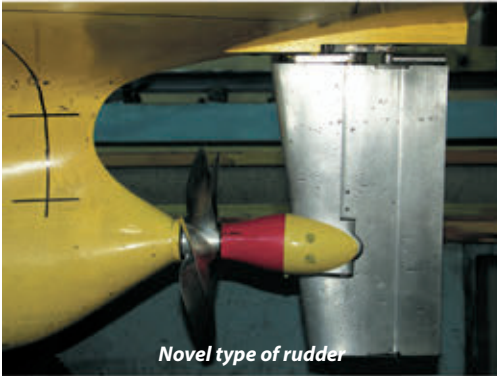

Novel type of rudder

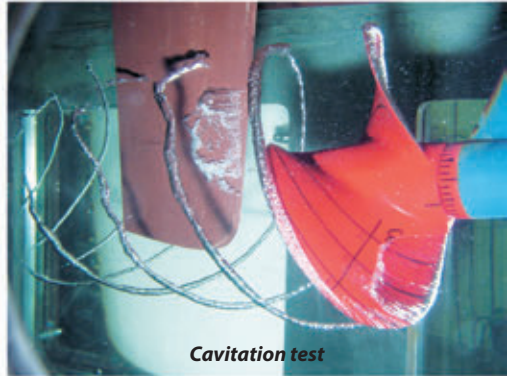

Cavitation test

*Photos courtesy
of the Gdańsk Ship Model Basin CTO S.A.*



Side launching test



Equipment for wake measurement



Model prepared for seakeeping test

MODEL TESTS

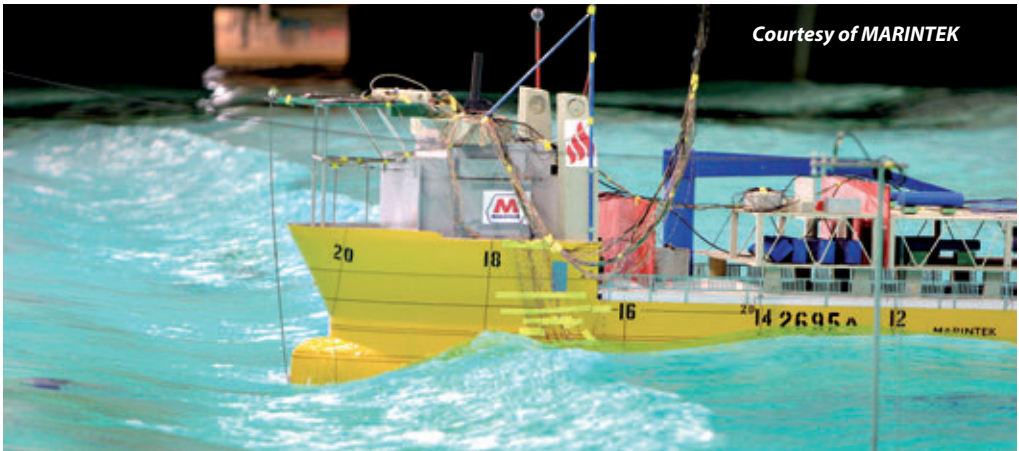

Courtesy of MARINTEK

Seakeeping test

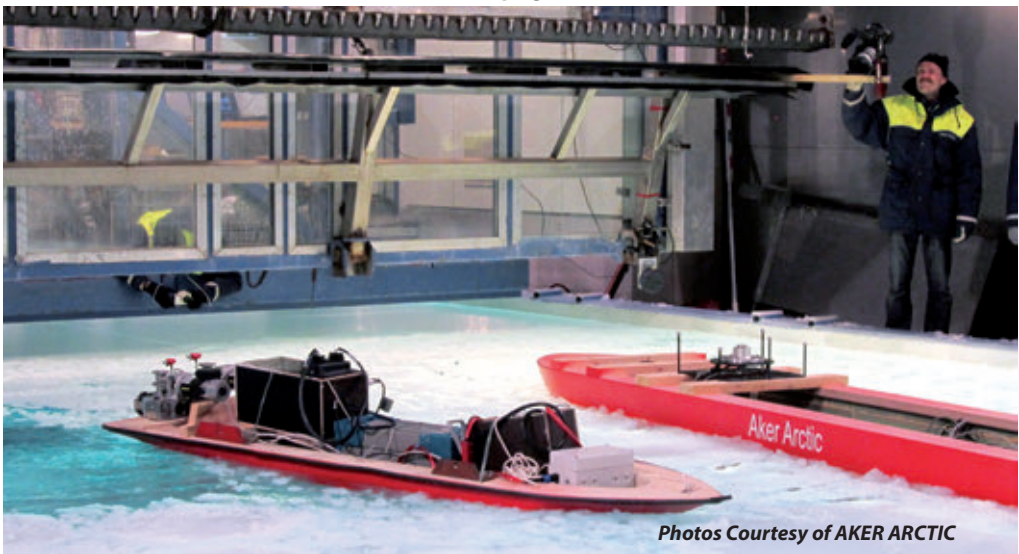

Photos Courtesy of AKER ARCTIC



Ice tests

Resistance tests are also carried out to measure the nominal **wake**, i.e. the wake of the ship without the propeller.

Further reading: ITTC Recommended Procedure 7.5-02-02-01

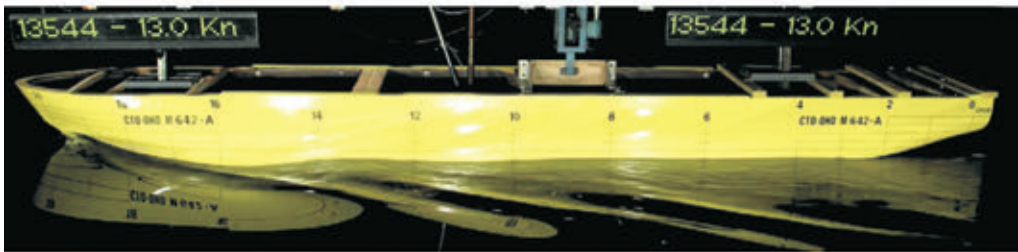
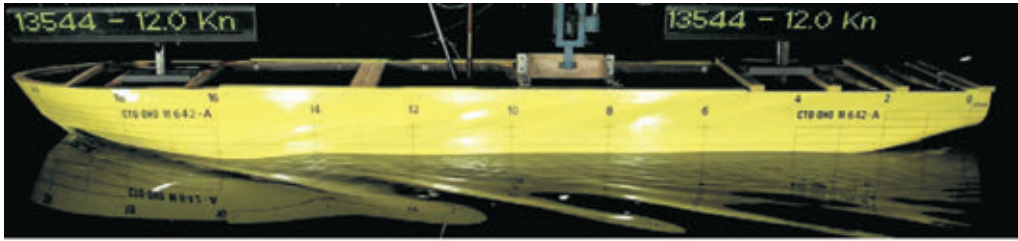

Photos courtesy of the Gdańsk Ship Model Basin CTO S. A.

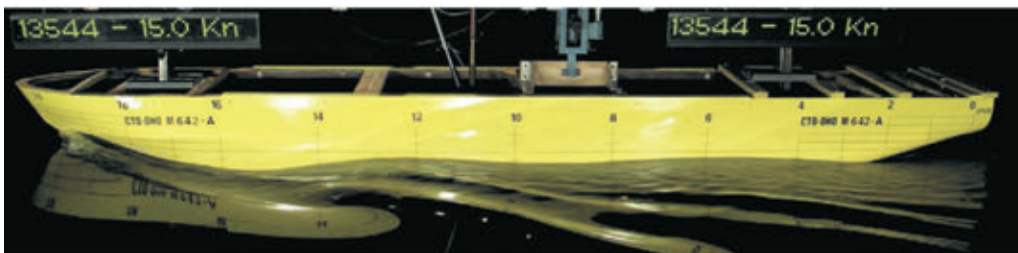
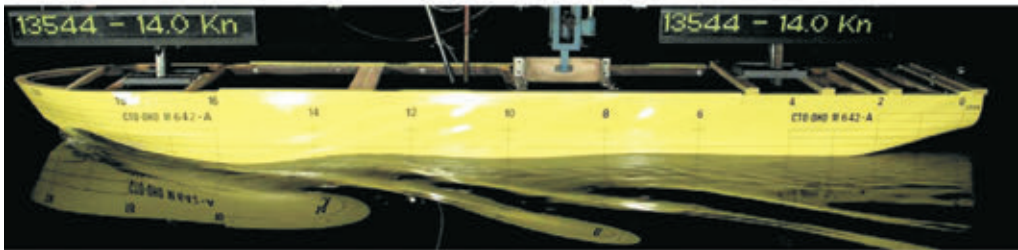

Self-propulsion tests – In the self-propulsion test, the model is towed at speeds giving the same Froude number as for the full-scale ship. During the test, propeller thrust, torque and rate of propeller rotation are measured. In many cases, stock propellers are used which are selected in view of the similarity in diameter, pitch and blade area to full-scale propeller. Propulsion tests are performed to determine the power requirements, but also to supply **wake** and thrust deduction, and other input data (such as the wake field in the propeller plane) for the propeller design.

Further reading: ITTC Recommended Procedure 7.5-02-03-01.



Photo: J. Babicz

*Model of container vessel VENUS tested at the Hamburg Ship Model Basin HSVA
Hull shape designed by BOG-Projekt*

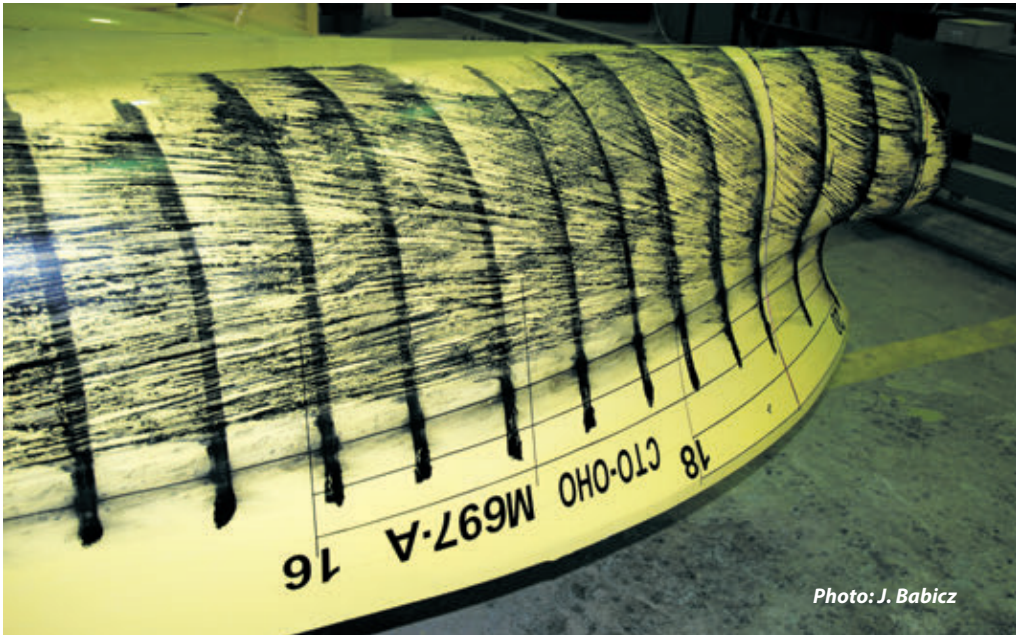

Photo: J. Babicz

*Model of MPV ARIADNA after paint test at the Gdańsk Ship Model Basin CTO S.A.
Hull shape designed by BOG-Projekt*

Propeller open water test – Although in reality, the propeller operates in the highly non-uniform ship **wake**, a standard propeller test is performed in uniform flow yielding the so-called open-water characteristics, namely thrust, torque and propeller efficiency.

Further reading: *ITTC Recommended Procedure 7.5-03-02-01*

The model resistance has to be converted for a prediction of the full-scale ship. Full-scale predictions are prepared usually according to the modified “1978 **ITTC Performance Prediction Method**”.

Standard Model Test Programme for ordinary cargo vessels

Nº	Test
First Part	
1	CFD analysis of Hull Lines
2	Fabrication of the model
3	Resistance test at design draught without rudder, 5 test runs
4	Self propulsion test with a stock propeller and rudder, design draught, 5 test runs
5	Paint test
7	Three-dimensional wake measurement at design draught and one speed
8	Generation of building frames
Second Part	
9	Manufacture of CPP model according to data from propeller maker
10	Final propeller open water test
11	Self propulsion test with the final propeller and rudder at design draught, 5 test runs
12	Cavitation tests
13	Resistance test at ballast draught, 5 test runs
14	Self-propulsion test with the final propeller and rudder at ballast draught, 5 test runs
Third Part	
15	Self-propulsion test with model draughts as expected at speed trials, 5 test runs

Model tests of the 57,300 DWT bulk carrier at HSVA

HSVA was contracted by a Chinese consortium to optimize the hull lines for a new 57,300 DWT Super-Handymax Bulk Carrier. Prior to performing calm water model tests, HSVA’s experts analysed and improved the hull lines using **computational fluid dynamics** calculations. The calculations were done with the CFD-software Comet which takes into account viscous effects as well as the free surface, i.e. the wave pattern of the vessel. According to HSVA’s experience, for high block vessels with very blunt waterlines the application of a viscous flow code is to be preferred in comparison with a potential flow code. Longer computing time must be accepted, but the advantages of using this code are clear: not only the bulbous **bow** design can be optimized but also the **wake field** at the location of the propeller.

Modified atmosphere

The model test program started with resistance and self-propulsion tests with a stock-propeller at four draughts. A 3-dimensional wake field measurement, a paint test and manoeuvring tests were the next step. All the tests were performed in HSV's 300m-long towing tank. The tests were continued with self-propulsion tests with a final propeller and **cavitation tests** in the **HYKAT**.

Modified atmosphere – Fruit and vegetables can be transported in a nitrogen reach atmosphere in order to slow down the ripening process. For this purpose **nitrogen generating plants** are installed on board. If the bananas are transported in containers, nitrogen is distributed to the cargo holds through piping system, which must ensure that a precise and pre-determined amount of nitrogen reaches each container.

Molten sulphur/bitumen tanker FS CHARLOTTE

According to the **Significant Ships** of 2006

Designed by Delta Marine, of Istanbul, the 11,000dwt combined molten sulphur and bitumen tanker is one of only very few vessels of this type in service worldwide. FS CHARLOTTE is a single-decked, single-screw tanker, with a double bottom and double skin, and has a total of 11 cargo tanks and two slop tanks. Six of the cargo tanks are designed to carry molten sulphur (1.80t/m³) at 180°C and five to carry bitumen (1.30t/m³) at 250°C. The cargo tanks are fully independent of the hull structure and mounted on special supports, to allow for expansion of the cargo at high temperatures. The Ulepsi tank support system from the Dutch company Beele Engineering was selected for the vessels.

Each of the cargo tanks, which can expand up to 80mm, weighs around 400t. The cargo discharge system is based around four Bornemann hydraulic pumps in two separate rooms. Two pumps each have a capacity of 400m³/h, for bitumen, and two are rated at 337m³/h for molten sulphur. Considerable attention also had to be paid to the effectiveness of the tank insulation system, so that in the event of any technical problems, the cargo temperature can be maintained sufficiently to keep the cargoes liquid, so that they can still be pumped ashore. The daily cargo heat loss, in the event of a heating system failure, is calculated to be only 1°C.

The tanker's classification covers an extensive list of requirements from Bureau Veritas, including those for vibration and noise, and the structure has additionally been analysed to comply with BV Veristar notation.

The propulsion plant has an output of 5400kW at 500 rev/min. The transmission is taken through a reduction gearbox to a CP propeller of 4400mm diameter, turning at 150 rev/min. Three 750kW heavy-fuel-burning diesel generators are installed, and heat for all cargo and domestic services is generated by two thermal oil boilers and an economizer.

Length, oa: 129.00m, Length, bp: 123.90m, Breadth, mld: 22.00m, Depth, mld: 12.50m, Draught design/maximum: 7.80/8.20m, Deadweight design/maximum: 11,500/12,500dwt, Gross tonnage: 9416, Propulsion power: 5400kW, Service speed at 85% MCR, 20% sea margin: 14.00 knots.

Moment – The attempt of a force to turn a body. It is usually measured by the product of the force and the length of lever.

Moment of inertia, mass moment of inertia – The product of the mass and the square of its perpendicular distance from the axis considered, which is summed for all the elements in the body considered.

Moment of statical stability – The moment which will try to return a ship to upright position when she is inclined.

Monitoring – Act of checking equipment and surroundings constantly in order to detect changes.

Monitoring system – A system designed to supervise the operational status of machinery or systems by means of instruments which provide displays of parameters and alarms indicating abnormal operating conditions.

Monitoring workstation – Workstation from where equipment and environment can be checked constantly. When several persons are working on the **bridge** it serves for relieving the **navigator** at the **navigating and manoeuvring workstation** and/or for carrying out control and advisory functions by the master and/or pilot.

Montreal Protocol – “The Montreal Protocol on Substances that Deplete the Ozone Layer”, 1987, and the respective adjustments/amendments 1990 to 1999.

Moonpool – A large opening through the deck and bottom of drill ships, diving support vessels or well intervention vessels, allowing to lower tools and instruments into the sea.

Mooring – Securing a ship at a pier or elsewhere by several lines or cables to limit her movement. Also, connecting a floating structure such as a drillship, a semi-submersible platform, a pipelaying barge, etc, to fixed points generally on the seabed and limiting its movements.

Multi-Buoy Moorings (MBM), conventional buoy moorings – A facility whereby a tanker is usually moored by a combination of the ship anchors forward and mooring buoys aft and held on a fixed heading. Also called conventional buoy moorings.

Single Point Mooring (SPM) – A facility whereby the tanker is secured by the bow to a single buoy or structure and is free to swing with the prevailing wind and current. Three types of single point mooring systems are commonly used: **Catenary Anchor Leg Mooring**, **Single Anchor Leg Mooring** and **Turret Mooring**.

Mooring and Towing Manual – A novel document with index and characteristics of machinery, equipment, shipboard fittings and ropes available for mooring and towing. It must be available on board for the guidance of the Master. The manual should include a number of pre-planned layouts such as:

- Basic Mooring Pattern
- Mooring Pattern for Excessive Winds
- Panama Canal Towing
- Emergency Towing

Further reading: *MSC/Cir.1175 Guidance on Shipboard Towing and Mooring Equipment.*

Mooring arrangement, mooring pattern, mooring layout – The geometric arrangement of mooring lines between the ship and the berth. See also **Arrangement of chocks and bitts for transit of Panama Canal**. **Further reading:** *Guidelines on Mooring of Ships*, www.bettership.com

Mooring drums – Mooring drums may be either split or undivided. For either type of drum, the diameter should be 16 times the wire rope diameter.

Non-split type mooring drum – An undivided mooring drum.

Split type mooring drum, split drum – A common drum divided by a notched flange into a wire storage section and a tension section. It is operated with only one layer of

Mooring equipment

wire on the tension section and theoretically can maintain a constant, high brake holding power.

Mooring equipment – Mooring equipment includes mooring winches, anchor windlasses, chain stoppers, fairleads and capstans.

Mooring fittings, shipboard fittings – **Bollards** and bits, fairleads, stand rollers and **chocks** used for the normal mooring of the ship and similar components used for the normal towing of the ship.

Note: *Generally, bollards, roller fairleads and chocks are not intended to be used by multiple mooring lines – only double Panama chocks can be belayed by two towing lines.*

Further reading: *MSC/Circ 1175 “Guidance on Shipboard Towing and Mooring Equipment”.*

Mooring lines – Lines (or cables) used to secure a ship at a berth. Mooring lines should be arranged as symmetrically as possible about the midship point of the ship.

Breast lines – Mooring lines leading ashore as perpendicular as possible to the ship fore and aft line. Breast lines restrain the ship in one direction (off the berth).

Note: *Due to collision with shore gantry cranes, breast lines are not used in container terminals.*

Head lines – Mooring lines leading ashore from the fore end or forecastle of a ship, often at an angle of about 45 degrees to the fore and aft line.

Spring lines – Mooring lines leading in a nearly fore and aft direction, the purpose of which is to prevent longitudinal movement (surge) of the ship while in berth. Spring lines restrain the ship in two directions: headsprings prevent forward motion and backsprings aft motion.

Stern lines – Mooring lines leading ashore from the after end or **poop** of a ship, often at an angle of about 45 degrees to the fore and aft line.

Further reading: *Loss Prevention Report “Understanding mooring accidents”, it can be freely downloaded from www.ukpandi.com*

Mooring restrain – The capability of a mooring system to resist external forces on the ship.

Mooring retention – Number of mooring lines by line breaking strength.

Requirements of EXXON rules for tankers

VESSEL SIZE (DWT)	MOORING RETENTION RANGE
Below 5100	120-280
5100-10,000	280-350
10,000-17,000	350-400
17,100-45,000	400-600

Mooring trials – Testing of main propulsion machinery with the ship moored.

Mooring winch – A winch with a drum which is used for hauling in or letting the mooring wires go. A warp end is also fitted to assist in moving the ship. See **mooring winches**.

Mooring winch brake design capacity, brake holding capacity – The percentage of the **minimum breaking load** (MBL) of a new mooring rope or wire it carries, at which the winch brake is designed to render. Winch brakes are normally designed to hold 80% of the line MBL and are set in service to hold 60% of the mooring line MBL. Brake holding capacity may be expressed either in tones or as a percentage of the line MBL.

Note: *The rated brake holding capacity is only achieved with one layer of wire on the tension drum. Operation with additional layers will decrease the brake holding capacity.*

Mooring winch brake – The brake is the heart of the mooring winch, since the brake secures the drum and consequently the mooring line at the shipboard end.

Band brakes – Band brakes follow the same principle as wrapping a rope around a **bitt** or **warping head** to hold a line force. This principle ensures for easy brake application, but has disadvantages such as sensitivity to friction changes and sensitivity to reeling direction. Oil, moisture or heavy rust on the brake linings or brake drum can reduce brake holding load capacity by 75%.

Mooring winches – Mooring winches secure the shipboard end of mooring lines, provide for adjustment of the mooring line length and compensate for changes in draft and tide. General requirements for shipboard mooring winches are dealt within **ISO** Standards 3730 and 7825.

Winches can be categorised by their control type (automatic or manual tensioning), drive type (steam, hydraulic or electric), by the number of drums associated with each drive, by the type of drums (split, undivided) and by their brake type and brake application (band, disc, mechanical screw, spring applied).

Automatic tension mooring winch, self-tension winch – Winches designed to heave-in automatically whenever the line tension falls below a certain pre-set value. Likewise, they pay out if the line tension exceeds a pre-set value. The use of the self-tension winches is not recommended except for mooring deployed at 90° to the ship axis.

Manual tension mooring winch – Manual winch always requires a person to handle the controls for heaving or rendering.

Non-split drum mooring winch – The undivided drum winches are commonly found on smaller ships. It is often difficult to spool and stow the wire on such a drum satisfactorily; when wires are handled directly off the drum, the final turns of the outer layer when under tension tend to bite into the lower layer. This could result in possible wire damage and difficulties when releasing the line. To reduce this problem, the winch with non-split drum should be placed at a sufficient distance from the fairlead to ensure that the wire can be properly spooled.

Split drum mooring winch – A winch with a drum divided by a notched flange into a tension section and a line storage section.

Mooring winches drives – The power source for the winch systems can be low-pressure hydraulic, high-pressure hydraulic, frequency-converter drive or pole-change electric drive.

Frequency converter drive – The latest and the most advanced electric drive technology. The stepless control allows the use of very low speed for clutch control. The drive system also offers good stalling performance, smooth and low noise operation.

High-pressure drive – The high-pressure (200 to 280 bar) drive is easy to install, operate and maintain. One pump can simultaneously supply a number of winches and other hydraulically-driven devices. The system consists of the hydraulic power pack and the winch with a hydraulic motor and the control valve mounted on the winch.

Low-pressure drive – The low-pressure drive gives dynamic braking, low noise level and is easy to operate. Further advantages are stepless speed regulation and high-torque. Because it has few mechanical parts, the low-pressure drive is less exposed to wear, lowering maintenance costs in this way.

MOORING WINCHES

Photo: C. Spigarski

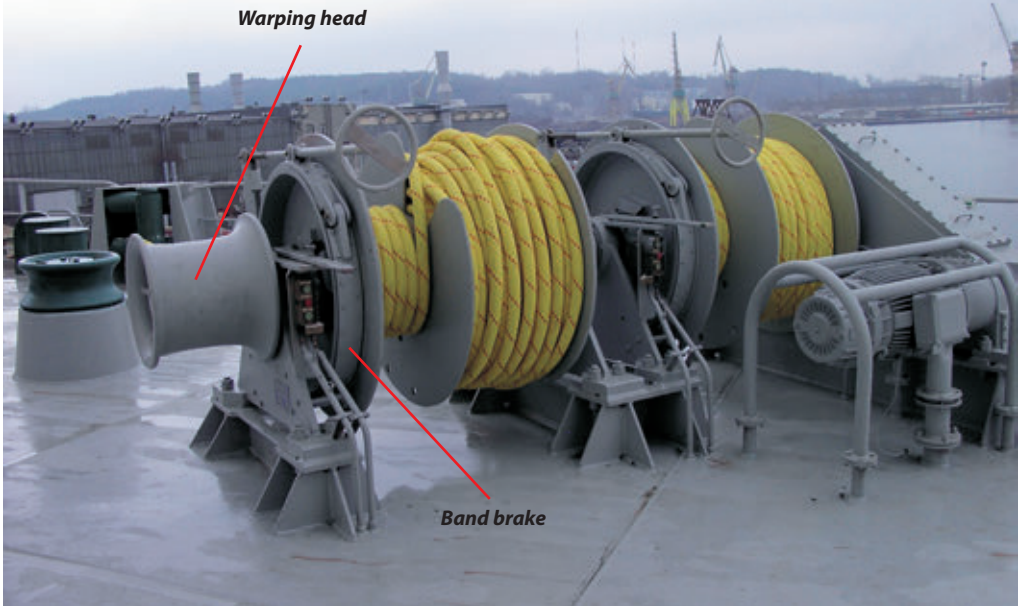

Electrically driven mooring winches with two split drums



Three speed pole-change drive – The nearly maintenance-free electric motor is equipped with standstill heating, temperature sensors and fail-safe brake. The winch control is precise and easy. Speed steps in both directions are obtained by a single lever. Electric systems are easy to install and provide quick start in all environmental conditions.

Moss Rosenberg system – The LNG cargo containment system developed by Moss Rosenberg Verft. The system features self-supporting spherical tanks connected at the equator to a single cylindrical supporting skirt, the lower portion of which is welded to the ship structure. The tanks are made of aluminium alloy, with internal diameters of up to and above 40m and a shell thickness of up to 50mm. Insulation (of polyurethane, styrofoam or equivalent) is arranged over the tank outer surface and the upper part of the skirt.

Motor enclosures – A casing provided according to the location of the motor, e.g. flame-proof, drip-proof, hose-proof.

Motor starter – An electronic controller for starting a motor from rest, accelerating it up to normal running speed and also stopping it.

Moulded breadth extreme – The maximum horizontal breadth of any frame section. The term breadth and beam are synonymous.

Moulded depth – The perpendicular distance in a transverse plane from the top of the flat keel to the underside of deck plating at the ship side.

Moulded lines – Lines defining the geometry of a hull as a surface without thickness; structural members are related to the moulded lines according to the standard practice, e.g. the inside surface of flush shell plating is on the moulded line; also the underside of deck plating.

Mud-box, strum box – A coarse strainer with a straight tailpipe down to the bilge.

Multifunctional Subsea Operation Vessels – Vessels developed for monitoring, supporting and subsea operation services. Usually suitable for a whole range of ROV/survey services and other subsea services such as supporting and monitoring pipe laying, maintenance work, seafloor construction, inspection and all types of seafloor charting and surveying using an ROV and a 3D echo sounder.

Multiple-container lifting – To reduce container loading and discharging times up to three containers are connected as a stack by twistlocks, and are lifted together as so-called “vertical tandem lift unit”.

Multi-purpose carrier NEPTUN TRADER

According to HANSA 12/2010, photos J. Babicz

The NEPTUN TRADER is one of 10 NEPTUN 30-type dry cargo vessels designed by Neptun Stahl (Germany) and built by Zhejiang Ouhua Shipbuilding Co.Ltd (China). The vessel is tailor-made for the transport of spacious project cargo, numerous general cargoes in palletized or bundled condition, steel coils, paper reels, ordinary bulk cargoes like grain, iron ore. All protruding wells seams are grind to ensure smooth wall surfaces. All pockets and lashing eyes in walls and on double bottom are flush mounted.

Cargo holds Nos. 2-4 (30.4x24.4m) can be equipped with tweendeck sets. Since the span of 24.4m and the demand for loads of 4 t/m² would require ultra heavy panels, the Owner, Neptune Stahl and MacGREGOR decided to divide the panels at centre line and support them by identical movable foundation racks.



The hydraulically folded hatch covers are some of the heaviest which MacGREGOR has ever applied, since each of the seven bigger folding pairs weights appr. 140t. Two independent power packs are installed, supplied by two pumps each, serving up to 2 folding hatch cover pairs. The hatch covers have a breadth of 26.6m and form a 120m long continuous stowage plane, just interrupted by the crane columns and ventilation towers.





Length, oa: 179.54m, Length, bp: 169.0m, Breadth, mld: 28.00m, Depth, mld: 15.10m, Draught design/maximum: 10.0/10.8m, Deadweight design/maximum without tweendeck panels: 29,618/33,217dwt, Hold capacity: 39,927m³/37,490m³ (TD), Main engine: MAN 6S50MC-C7 derated to 8800kW, Service speed: 15.5 knots, Aux. engines 2x6L16/24 – 510kW + 5L16/24 – 425kW, Complement: 30 persons.

Multi-purpose dry cargo vessel – Usually a smaller ship with one or two box-shaped holds, reinforced tanktop (15-20t/m²) to allow heavy and project cargoes, often fitted with a **removable tweendeck**. Ships of this type are able to transport a large number of commodities, such as general cargoes, containers, bulk cargoes, steel coils, timber and paper products, dangerous goods, etc. It is predicted that a large number of such vessels will be needed to replace the fleet of ageing general cargo ships.

Multi-purpose dry cargo vessel INNOGY SPRITE

According to **HSB International** September 2002

The 19,300 dwt vessel was completed by Damen Shipyards and delivered to Carisbrooke Shipping Limited in 2003. In the world today flexibility is the key factor, therefore vessel is entirely fitted to carry containers, bulk fertilizers, dangerous goods, steel and paper cargoes. Cointainer capacity is 1232TEU: 530 TEU in holds with stack loads 100t/TEU and 130t/FEU, and 702TEU on deck with stack loads 50t/TEU and 65t/FEU.

The vessel is provided with three Liebherr cylinder-luffing cranes 60t/18m, 40t/32m. She has two box holds; the Hold No1 with a length of 37.68m and the Hold No2 of 72.84. The width of both holds is 20.20m and their height under the hatch covers is 12.28m. The holds are ventilated mechanically with a capacity of 12 air changes per hour. The tanktop is strengthened generally to 15t/m² and maximum up to 20t/m² according to loading pattern. Six tiers of lashing eyes are fitted flush with the cargo hold side platings.

Both holds are closed by MacGREGOR high stowing folding type hatch covers, operated by means of external hydraulic cylinders. A pontoon type hatch panel, operated by the deck cranes, is placed between the forward and aft folding panels closing the Hold No 2. The holds are provided with lift-away steel pontoons forming non-weatertight tweendeck (uniform load 5t/m²). Pontoons can be locked in two positions. They can be used as grain bulkheads.

A Framo anti-heeling system is fitted in between the cargo holds. The system automatically provides compensation of angles due to cargo handling with the deck cranes. The system features 1120m³/h reversible propeller pump operating in both directions by reversing the electric motor. In case of heavy cargo handling, pre-heeling can also be carried out.

Multi-purpose/forest product carrier SUOMIGRACHT

The prime mover consists of a two-stroke engine rated 7860kW driving a 5.10m diameter four-blade CP propeller. Service speed of 14.9 kt on 30t HFO (IFO 380).

A 1500kW shaft alternator of 1875kVA, 400VAC, 50Hz is driven by a tunnel gear-based power take-off. A highly elastic torsionally Vulkan Rato-S flexible rubber shaft coupling is fitted between the diesel engine and the tunnel gearbox. Furthermore, two generator sets are installed, each consisting of an ABC diesel engine and A. van Kaick generator, output 820 kVA, 400 VAC, 50Hz. A harbour/emergency generator set of 330 kVA is installed on the boatdeck.

Length, oa: 159.99m, Length, bp: 152.34m, Breadth, mld: 23.70m, Depth, mld: 11.95m, Draught maximum: 8.41m, Deadweight maximum: 19,465dwt, Gross tonnage: 14,357, Propulsion power (MCR): 7860kW, Service speed at 90% MCR: 14.90 knots.

Multi-purpose/forest product carrier SUOMIGRACHT

According to **Significant Ships** of 2004

Transportation of forest products, such as paper, pulp and sawn timber is a core activity of the Dutch owner Spliethoff which manages more than 55 multi-purpose tweendeck cargo vessels.

Photo courtesy of Stocznia Szczecińska Nowa Sp. z o. o.



The multi-purpose/forest products carrier SUOMIGRACHT

A Wärtsilä 6L64 main engine, developing 12,060kW at 333rpm drives a CP propeller at 105 rpm through a Renk gearbox for a service speed of 19.30 knots (design draught, 85%MCR).

SUOMIGRACHT, the first of the Spliethoff newbuildings from the Polish shipyard Stocznia Szczecińska Nowa, was delivered in November 2004. The vessel is the larger, modified version of earlier vessels built at Szczecin. She features only two box-shaped holds. The upper deck hatch covers are a combination of hydraulically-operated folding and rolling panels, with the second deck closed by pontoons handled by the ship cranes, and capable of being positioned to form a tweendeck at three levels, or located vertically as grain bulkheads or cargo divisions.

Although forest product export from Finland provides ship main employment, transporting a wide range of backhaul cargoes are essential to her economic running. Consequently, three side-mounted 120, 90, 55 tonne SWL hydraulic deck cranes are fitted, unusually positioned two on port side and one starboard, with tandem lifts up to 240 tonnes possible for project

cargoes. Container capacity is 1283TEU (555 in holds and 728 on deck, where 120 reefer plugs are provided), and the ship can accommodate 1022 stability TEU homogeneously loaded to 14tonnes.

The innovative TTS side-loading system installed in the earlier series has again been adopted to facilitate handling of forest products, and comprises five hydraulically-operated 4m x 2m loading platforms, each lifting 16tonnes. The shell door of the sideport structure is raised and pivoted outwards when the loaders are in use, forming a rain shelter, which allows for all-weather operation. The system is capable of making transfers between the quayside and the lower and intermediate tweendeck levels at an hourly rate of 500tonnes. Movement into the Hold No1 is through watertight doors in the transverse bulkhead.

The vessel features a hull form incorporating an asymmetric stern configuration aimed at improving **wake field**. The Wärtsilä 6L64 main engine, developing 12,060kW at 333 rev/min, drives a CP propeller at 105 rev/min, through a Renk gearbox. The ship is fitted with 1000kW main-engine-driven alternator Taiyo/FEK 45DL-4.

Length, oa: 185.40m, Length, bp: 173.50m, Breadth, mld: 25.30m, Depth, mld: 14.60m, Draught design/maximum: 10.00/10.60m, Deadweight design/maximum: 21,350/23,750dwt, Gross tonnage: 18,100, Propulsion power (MCR): 12,060kW, Service speed at 85% MCR: 19.30 knots.

Mushroom – A cover permanently fitted above a ventilator located in the weather deck, usually round and of larger diameter than the ventilator.



Musketeer door – Marine door with a novel locking mechanism developed by WINEL Company (the Netherlands). The Musketeer locking system incorporates a 33:1 power transmission from manual operating force to the locking device; as a result the door can be securely locked and opened even using an elbow or a shoulder only.

Mussel cutter CORNELIA YE-157, according to HSB International June 1998

The mussel catch is led into two bins situated in port and starboard side. In these two bins water derived from two shower and rising heads flushes away sand, soil and loose tarra from the mussels. Next, the mussels are transported by a conveyor belt to a seawater shower where they are once again rinsed. Next, they are transported to a longitudinal conveyor belt, and then onto a transverse conveyor distribution belt. In this way, the mussels are evenly distributed over two mussel holds.

National authorities – Either the government of the country in which the ship is registered, or the Administration delegated to deal with merchant shipping for that country.

Natural gas (dry) – Gas without condensation at common operating pressures and temperatures where the predominant component is methane with some ethane and small amounts of heavier hydrocarbons. The gas composition can vary depending on the source of natural gas and the processing of the gas. Typical composition in volume Methane 94.0%, Ethane 4.7%, Propane 0.8%, Butane 0.2%, Nitrogen 0.3%. Density liquid 0.45kg/dm³, Calorific value (low) 49.5MJ/kg, Methane number 83.

The gas may be stored and distributed as compressed natural gas (CNG) or liquefied natural gas (LNG).

Natural gas fuel – With new emission control regulations taking effect, gas as a ship fuel, once banned, is now re-emerging as an environmentally and economically attractive option. Compared to oil, natural gas has two key advantages: high efficiency and a lower environmental impact: 100% less of SO_x, 85-90% less of NO_x, and up to a 25% reduction in CO₂ emissions.

Whilst there are a number of ways to meet emissions restrictions in Emission Control Areas, such as the use of low sulphur fuel or the installation of a **scrubber**, natural gas is an appealing answer. In liquid form natural gas cannot ignite: it is simply too cold. When evaporated into gaseous form it is still very difficult to find right mixture of gas and air to allow it to burn. Additionally, the ignition temperature of the air-gas mixture is very high (600°) and there are no surfaces in the engine room hot enough to ignite gas.

Until recently, **LNG tankers** were the only ships equipped with gas burning propulsion systems using their cargo boil off as fuel. These ships used to be equipped with boilers and steam turbines until the break through in 2004 of the construction of the first dual fuel diesel-electric propulsion on board the **LNG tanker GAZ DE FRANCE ENERGY**.

In early June 2009, the **IMO** Committee on Maritime Safety (MSC) lifted the ban on natural gas as a ship fuel by adopting Resolution MSC 285(86), called "Interim Guidelines on Safety for Natural Gas-Fuelled Engine Installations in Ships". Developed by the IMO subcommittee on Bulk Liquid and Gases (BLG) with GL assistance over the past few years, the Interim Guidelines are the first step towards the envisioned general code for gas as a ship fuel, the so-called **IGF Code**, which is currently under development by IMO and is expected to enter into force conjointly with the revision of **SOLAS** 2014.

See also **Platform supply vessel VIKING ENERGY**.

Natural gas-fuelled ferry GLUTRA

Financed by the Norwegian Directorate of Public Roads, a car ferry GLUTRA with a capacity of 100 private cars was designed for operation on natural gas, based on a new set of Norwegian safety standards for gas fuelled passenger ships. The ship was built at Langsten Yard in Norway. The ferry is propelled by four gas engine generator sets giving power to two electric driven compass thrusters, one in each end of the ship. Liquid Natural Gas (LNG) is stored in two LNG tanks under the main deck.



Photo courtesy STX Europe

LNG double-ended car/passenger ferry GLUTRA delivered in 2000

The LNG fuel system was sealed off under main deck in two separate compartments containing one LNG tank and evaporator each. Evaporated gas is fed in double piping to the engine room at about 4 bar. The size of the LNG tanks is 32m³ each having enough capacity to take a full truck load. Refueling takes place every 4th or 5th day when the ferry is docked for the night and no passengers are onboard. Refueling time is about one hour for a truckload of 40m³ of LNG. The truck connects to the filling station through a hatch at the shipside.

When choosing gas engines, only gas engine generator sets for power production were available at the power range of 500-800kW per unit. A final argument for choosing electric transmission was the freedom of putting the generator sets at different locations onboard the ferry. Four generator sets, 675kW each, were put in separate engine rooms above the main deck. This was at the same time an elegant way to meet the strict requirement regarding consequences of an explosion in the engine room. An explosion analysis showed that in the worst case the door of the engine room would burst and immediately release the pressure without affect the other engine rooms. The engine room are arranged two and two, with the main switchboard for the electric power, separating them. In normal operation two engines gives sufficient power for propulsion and other energy consumers. The third generator set is backup or may be added to increase speed or higher energy demand due to weather conditions. The fourth generator set could then be available for maintenance. By this arrangement the ferry could be in operation 365 days a year in a period of 2-3 years.

Natural gas-fuelled ferry VIKING GRACE

Length, oa: 94.80 m, Breadth: 15.70 m, Depth: 5.15 m, Deadweight: 640dwt, Service speed 12 knots, LNG fuel system: 2 AGA CRYO vacuum insulated cryogenic tanks 32m³ per unit, Engines: 4 lean burn pre-chamber spark ignited gas engines Mitsubishi GS12R-PTK, 12 cylinder V, 675 kW per unit, Propulsors: 2 Schottel Twin Propeller STP 1010, 1000 kW each, diameter 2.15 m.

Natural gas-fuelled ferry VIKING GRACE

The PaxCar ferry VIKING GRACE is the largest LNG fuelled passenger ship. Built in STX Turku yard, the ship is designed for efficient year-round service on the trans-Baltic route linking the southwest Finnish port of Turku with Stockholm.



Finnish ferry VIKING GRACE built in 2013

To ensure self-reliance and scheduling in Baltic winter conditions, the hull has been strengthened to Finnish/Swedish 1A Super ice-class criteria. The cruise-standard ferry has been laid out for 2800 passengers, with a total of 880 cabins. The maximum ro-ro freight payload equates to the 1275m lane of main deck loading capacity, complemented by some 550m lane for cars, with provision of a similar capacity on the intervening hoistable deck level.

The dual-fuel electric propulsion is based on Wärtsilä 50DF-type machinery. Four eight-cylinder 50DF engines drive ABB alternators delivering power to the main switchboards for two 10,500kW ABB propulsion motors and other shipboard consumers. With two independent engine rooms and two drive lines the propulsion system offers a high degree of redundancy.

LNG fuel is carried in two 200m³ stainless steel, vacuum-type tanks located in an open area right aft, above the stern ro-ro ramp. The tanks and associated bunker handling equipment, safety and automation systems constitute the integrated LNGPac solution developed by Wärtsilä.



Wärtsilä's patented Cold Recovery System utilises the latent heat of LNG in air conditioning systems, reducing the amount of electricity consumed in cooling compressors. Significant operational savings and an increase in overall vessel efficiency are the result.

In addition, Wärtsilä supplied two 2300kW bow thrusters and a 1500kW stern thruster, two stainless steel fixed-pitch built-up-type main propellers and complete propeller shaft lines with shaft-line seal systems.



Wärtsilä Gas Valve Unit Enclosed Design (GVU-ED™) installed directly in the Engine Room

The main functions of the Gas Valve Unit are to regulate the gas feeding pressure to the engine, and to ensure a fast and reliable operation and shut down of the gas supply. GVV-ED™ is standard part of Wärtsilä's gas propulsion package.

NATURAL GAS-FUELLED FERRY VIKING GRACE



NATURAL GAS-FUELLED FERRY VIKING GRACE



Nautical chart

Wärtsilä Compact Silencer System minimises noise emissions from the engines, being particularly effective in the abatement of disturbing low frequency impulses. Furthermore, the Wärtsilä propellers have been designed with the lowest possible pressure impulses.

Length, oa: 218.60m, Length, bp: 135.40m, Breadth, mld: 31.80m, Depth to main deck: 13.80m, Design draught: 6.80m, Gross tonnage: 57,700GT, Service speed: 21.8 knots, Maximum speed: 25.6 knots, Lane metres: cargo 1275 m, cars 500m on Deck 4 plus 500m on Deck 5, Propulsion: 4 Wärtsilä dual fuel (LNG/diesel) 8L50DF engines, Combined output: 30,400 kW.

Nautical chart – A map of water area including the adjoining land, intended primarily for use of mariners.

Nautical mile – Distance of one minute of longitude at the equator, equal to 1852m.

Naval architecture – The science and practice of designing ships as distinguished from their construction which is covered to shipbuilding. Modern naval architecture was established during the industrial revolution with the basic methodologies established for hull design, resistance prediction, propulsion, stability and structural strength.

Navigation – All tasks relevant for deciding, executing and maintaining the course and speed in relation to waters and traffic.

Navigation aids – Magnetic compass, gyrocompass, radar, echo sounder, rudder angle indicator, propeller revolution counter, rate of turn indicator.

Navigation aids vessel – A vessel intended for buoy handling. See **Aids to navigation service vessel**.



Navigating and manoeuvring workstation – The main **workstation** on the **bridge** where speed and course are considered and controlled, preferably conceived for working in the seated position with optimum visibility and integrated presentation of information and operating equipment. It shall be possible from this place to operate the ship safely, in particular when a fast sequence of action is required.



Navigation lights – All seagoing ships must be equipped with running and signal lights in compliance with the International Regulations for Preventing Collision at Sea (COLREG). A navigational light panel is installed in the **wheelhouse** for the control of all running and signal lights.

Running lights – Sidelight starboard and port, masthead forward and aft, stern light.

Signal lights – Anchor forward and aft, not-under-command, towing lights, hampered vessel, flashing lights for hovercrafts.

All-round light – A light showing an unbroken light over an arc of the horizon of 360 degrees.

Flashing light – A light flashing at regular intervals at the frequency of 120 flashes or more per minute.

Masthead light – A white light placed over the fore and aft centreline of the vessel showing an unbroken light over an arc of the horizon of 225 degrees and so fixed as to show the light from right ahead to 22.5 degrees abaft the beam on either side of the vessel.

Sidelights – A green light on the starboard side and a red light on the port side each showing an unbroken light over an arc of the horizon of 112.5 degrees and so fixed as to show the light from right ahead to 22.5 degrees abaft the beam on its respective side.

Sternlight – A white light placed as nearly as practicable at the stern showing an unbroken light over an arc of the horizon of 135 degrees and so fixed as to show the light 67.5 degrees from right aft on each side of the vessel.

Towing light – A yellow light of the same characteristics as the sternlight.

Navigator – The person navigating, operating the **bridge** equipment and manoeuvring the ship.

NAVTEX – An international maritime radio telex system sponsored by **IMO** and **IHO**, which automatically receives the broadcast telex information such as navigational, meteorological warnings and search and rescue (SAR) alerts on 24-hour watch basis.

NAVTEX is a method of transmitting navigational warnings and weather forecasts from designed coast radio stations. All English-language transmissions are made on 518 kHz and each station is allocated several time “slots” during the day, when it is permitted to transmit. These are normally emitted at four-hour intervals. Except for the gale warnings and search and rescue messages which can be transmitted at any time. Reception of NAVTEX is limited to an area of 200-300-mile radius around each transmitting station, although considerably greater ranges are possible at night.

Necking effect

Necking effect – A term describing local **corrosion** at junction of plating and stiffeners due to flexure effects caused by reverse, cycling loading with loss of coating or shedding of **scale** exposing fresh steel to further corrosion. The corrosion rate may be rather high and accelerates with thinning of the material.

Net pick-up – A net protection ring with U-shaped cross-section. The net pick-up is the ancillary component of the **sterntube** aft seal and its purpose is to prevent netting and fishing lines from entering the seal.

Net cutters – Stainless steel net cutters are mounted on the rope guard, overlapping the **propeller hub**.

Nitrile rubber – A synthetic rubber that is a copolymer of butadiene and acrylonitrile. It has good resistance to petroleum-based substances and is often used in seals.

Nitrogen generator – Chemical **tankers, gas carriers** and reefer ships need clean, dry nitrogen for **inerting**, purging and cargo padding. Onboard nitrogen generators are the most efficient way to provide this. There are two main types of nitrogen generators. One type uses hollow fiber membrane technology and other one is based on the Pressure Swing Absorption (PSA) process. **Inert gas generators** can produce nitrogen too. Molecular sieves remove the CO₂ present in the inert gas.

For more information visit www.wartsila.com



Wärtsilä Moss Nitrogen generator uses state of the art membrane technology

Membrane technology – The air we breathe contains approximately 78% nitrogen, 21% oxygen and 1% other gases such as argon and water vapour. Membrane systems use this unlimited supply of raw material to produce specific purities of nitrogen.

Selective permeation is the general principle behind a membrane system. Each gas has a characteristic permeation rate that is a function of its ability to dissolve and diffuse through a membrane. The “fast” gases, O₂, H₂O, CO₂ permeate through the membrane wall much faster than the “slow” gases, thus separating the original mixture into two streams. The driving force of the separation process is the differential partial pressure, which is created between the compressed feed airside and the low-pressure side of the membranes.

The membrane separator consists of a bundle of hollow fibres in a cylindrical shell, arranged much like a shell and tube heat exchanger. The compressed air is fed to the inlet end of the separator, and flows inside the hollow fibres towards the opposite end. On the way the air molecules start to permeate through the walls of the fibres according to their permeability. Oxygen, carbon dioxide and water vapour permeate faster than nitrogen, and the result is a super-dry nitrogen stream at the outlet end. The secondary oxygen-rich stream is vented to atmosphere.

PSA-type nitrogen generator – A typical nitrogen generation plant based on the **Pressure Swing Absorption** (PSA) process consists of two absorption towers filled with the carbon molecular sieve. Compressed, purified air passes through the towers and oxygen is absorbed on the carbon molecular sieve, whilst nitrogen-enriched gas leaves the tower. While absorption is taking place in one tower, the second tower is regenerated by returning to ambient pressure, with the oxygen enriched gas vented from the system.

Nitrogen oxides (NO_x) – Nitric oxide (NO) and Nitrogen dioxide (NO₂) are usually grouped together as NO_x emissions. The NO_x emissions contain predominantly NO which forms mainly in the oxidation of atmospheric nitrogen in high temperature. NO can also be formed through oxidation of the nitrogen in fuel and through chemical reactions with fuel radicals.

Nitrous oxide – Not to be confused with nitric oxide (NO) or nitrogen dioxide (NO₂), nitrous oxide (N₂O) a potent greenhouse gas. Nitrous oxide is naturally present in the atmosphere as part of the Earth's nitrogen cycle, and has a variety of natural sources. However, human activities such as agriculture, fossil fuel combustion, wastewater management, and industrial processes are increasing the amount of N₂O in the atmosphere. Nitrous oxide molecules stay in the atmosphere for an average of 120 years before being removed by a sink or destroyed through chemical reactions. The impact of 1 pound of N₂O on warming the atmosphere is over 300 times that of 1 pound of carbon dioxide.

Node – A point that is at rest in a vibrating body.

Noise Code – A new mandatory code for the protection of seafarers against noise on board. The Code lays down the permitted maximum noise limits on ships to protect seafarers against noise and contains detailed provisions on how to carry out the necessary measurements to ensure compliance with the noise levels. It was decided that the Code enters into force on 1st July 2014, since it will apply to ships for which a building contract is concluded on or after 1 st July 2014, or the keel of which is laid on or after 1st January 2015, or which are delivered on or after 1st July 2018.

Accommodation should be sited both horizontally and vertically as far away as is practicable from sources of noise such as propellers and propulsion machinery. Machinery casings should, where practicable, be arranged outside superstructures and deckhouses containing accommodation spaces. Where this is not feasible, passageways should be arranged between the casings and accommodation spaces, if practicable.

Limits for noise levels (dB(A)) are specified for various spaces as follows:

Designation of rooms and spaces	Ship size	
	1,600 - 10,000 GT ≥ 10,000 GT	
Work spaces		
Machinery spaces	110	110

Non-combustible material

Machinery control rooms	75	75
Workshops	85	85
Non-specified work spaces (other work areas)	85	85
Navigation spaces		
Navigating bridge and chartrooms	65	65
Listening posts, incl. navigating bridge wings and windows	70	70
Radio rooms (with radio equipment operating but not producing audio signals)	60	60
Radar rooms	65	65
Accommodation spaces		
Cabin and hospitals	60	55
Messrooms	65	60
Recreation rooms	65	60
Open recreation areas (external recreation areas)	75	75
Offices	65	60
Service spaces		
Galleys, without food processing equipment operating	75	75
Serveries and pantries	75	75
Normally unoccupied spaces		
Spaces not specified	90	90

Where reasonably practicable, it is desirable for the noise level to be lower than the maximum levels specified above.

Non-combustible material – A material which neither burns nor gives off flammable vapours in sufficient quantity for self-ignition when heated to approximately 750°C, this being determined in accordance with the **Fire Test Procedures Code**, (SOLAS).

Nondestructive test (NDT) – Any test that does not damage the material under test and can, therefore, be used on the finished items.

Further reading: *IACS Rec.69 “Guidelines for nondestructive examination of marine steel castings”.*

Nondestructive testing methods of hull welds – Inspection of welded joints is carried out by non-destructive methods, such as radiography, ultrasonic, **magnetic particle** or liquid penetrant.

Radiographic testing (RT) and **ultrasonic testing (UT)** are used for detection of internal discontinuities. Generally, they supplement each other. RT is the most effective method in detecting three-dimensional discontinuities, such as **porosity** and **slag**, and is less effective for two-dimensional discontinuities, such as laminations or cracks. UT, on the other hand, is generally most effective for detecting laminations and cracks and is less effective for detecting porosity and slag. Magnetic particle or **liquid penetrant** inspection is used for surface inspection of welds.

Further reading: *ABS Guide for “Nondestructive Inspection of Hull Welds” (2002), can be downloaded from www.eagle.org*

Non-organic grease – A type of grease which does not attack the seal.

Non-return valve – A valve that is designed to prevent a reverse flow. If the valve disc is not attached to the spindle, it is called a screw down non-return (SDNR) valve.

Non-volatile petroleum – Petroleum having a flash point of 60°C or above, as determined by the closed cup method of test.

Normal conditions (on the bridge), normal sailing conditions – Normal conditions exist when trouble-free operation of the equipment required for the **bridge** operation is given and environmental conditions with regard to weather and traffic do not cause excessive operator workloads and/or impair visibility.

Normal operational and habitable condition – A condition under which the ship as a whole, the machinery, service, means and aids ensuring propulsion, ability to steer, safe navigation, fire and flooding safety, internal and external communications and signals, means of escape, and emergency boat winches, as well as the designed comfortable conditions of habitability are in working order and functioning normally, (acc. to **SOLAS**, chapter II-1, Part A).

Normalising – The type of steel heat treatment. The steel is heated to 850-950°C depending upon its carbon contents and then allowed to cool in air. The resulting product is hard strong steel with a refined grain structure.

Not under command (NUC) – A vessel which through exceptional circumstances is unable to manoeuvre as, required by the COLREGs.

Notch ductility – The property of a material whereby it will withstand stress due to a notch or area of stress concentration without cracking or failure.

NO_x emissions – see **EXHAUST GAS EMISSIONS FROM SHIPS**.

NO_x REDUCER SYSTEM

The Wärtsilä NO_x Reducer System is based on the **Selective Catalytic Reduction** technique for Nitrogen Oxide (NO_x) reduction.

The main components are:

1. Reactor housing
2. Catalyst elements
3. Soot blowing unit
4. Urea injection and mixing unit
5. Urea dosing unit
6. Control and automation unit
7. Urea pumping unit

The reactor is a steel casing consisting of an inlet and an outlet cone, catalyst layers, a steel structure for supporting the catalyst layers and a soot blowing system. Compressed air connections for soot blowing are installed at each catalyst layer. The reactor is equipped with a differential pressure transmitter for monitoring the condition of the catalyst elements, and a temperature transmitter for monitoring the exhaust gas outlet temperature. One SCR Reactor is installed per engine and exhaust gas pipe.

The urea pump unit supplies urea to the dosing system and maintains a sufficient pressure in the urea lines. A suction filter protects the pump and the downstream equipment from impurities. Excess urea returns to the storage tank through an overflow line.

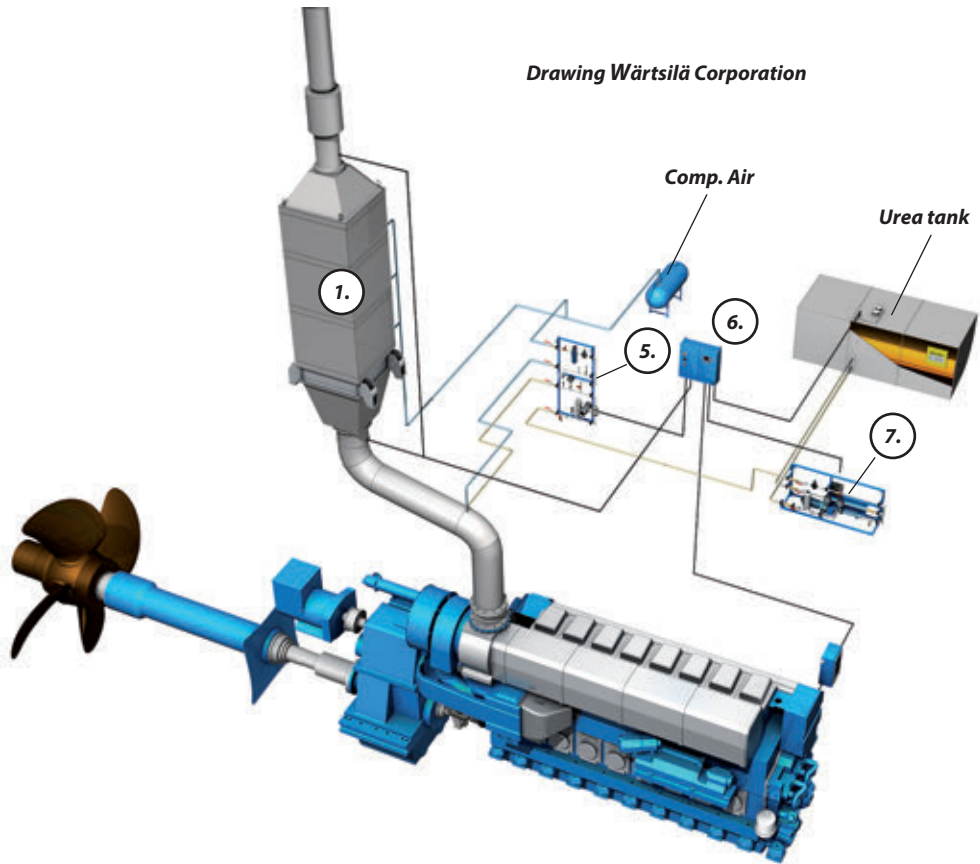

The dosing unit defines the correct urea dosing rate for the injection system and adjusts the urea flow accordingly by a control valve. The components in the unit are mounted on a frame, forming a compact module. One pump unit can be used for several SCR reactors while one dosing unit is installed for each SCR reactor.

The urea injector sprays reducing agent into the exhaust gas duct. After injection of the reducing agent, the exhaust gas flows through the mixing pipe to the reactor, where the catalytic reduction takes place. The reactor is equipped with a soot blowing system for keeping the catalyst elements clean.

Further reading: *Wärtsilä Environmental Product Guide*

NOx Technical Code – The Technical Code on Control of Emission of Nitrogen Oxides from Marine Diesel Engines adopted by **IMO**. This document covers engine testing, certification and onboard verification procedures to demonstrate continuing compliance with the applicable NOx emissions limits.

Nylon – A synthetic polymer which is chemically inert and resistant to erosion and impingement attack. It is used for orifice plates, valve seats and as a coating for salt water pipes.

OBO – Abbreviation for a **combination carrier** designed to carry **oil**, bulk cargoes or ore cargoes.

Ocean area coverage

Area A1 Covered by VHF coast radio stations providing digital selective calling (DSC) alerting services (typically 20 NM from the coast).

Area A2 Covered by MF coast radio stations providing continuous DSC alerting (typically about 200 NM from the coast).

Area A3 Covered by the Inmarsat geostationary satellites (typically global coverage about 70N to 70S latitude 0 or DSC HF radio).

Area A4 For those outside the other areas (only required for vessels sailing in the polar regions out of Inmarsat satellite coverage). Served by DSC HF radio.

Ocean areas – Navigation area beyond the outer limits of coastal waters where freedom of course-setting is not restricted in any direction for a distance equivalent to 30 minutes of sailing at the relevant ship speed.

Oceanographic research vessel RRS JAMES COOK

31 August, 2006, the Natural Environment Research Council (NERC) took delivery of the newest addition to their research vessel fleet, the RRS JAMES COOK.

The design for the RRS JAMES COOK was developed by Norwegian design company Skipsteknisk AS, a leader in the design of sophisticated research vessels. The hull built by steel ship specialist CRIST of Gdańsk, Poland, was outfitted in Norway at Flekkefjord Slipp & Maskinfabrik AS.

Housing eight science laboratories, the vessel can accommodate up to 31 scientists and 23 crew and is capable of spending up to 50 days at sea. In designing the new vessel, safety was paramount and NERC took into account the risk of running aground in isolated, uncharted waters where there is no possibility of rescue, and the risk of puncture damage to the hull from icebergs or growlers. As a result, the vessel incorporates a double skin around the main propulsion and generator rooms and this concept should enable the ship to sail to the nearest port for repairs.

Power for propulsion and all ancillary functions is provided by a “power station” comprising four Wärtsilä 9L20 diesel engines coupled to Siemens alternators. Total power available when all four generators are running is 6840kW. Each generator unit is independently raft mounted, the rafts being resiliently mounted on the tank top in order to minimise underwater radiated noise.

Two 2500kW electric motors drive twin FP 3600mm diameter, five-blade propellers. In addition, there are four thrusters, two each at the bow and stern. The two stern thrusters are both tunnel types, of 800kW (Super-Silent) and 600kW. One bow thruster is of tunnel type, a Super-Silent design rated at 1200kW. The other is a retractable azimuthing unit of 1350kW. This combination of propulsors provides the vessel with a DP1 capability.

In addition to a deep sea ROV, the JAMES COOK is fitted with two dropped keels which project 2.5m below the ship’s bottom and house sensors.

Length oa: 89.20m, Length bp: 78.60m, Breadth: 18.60m, Depth to upper deck: 9.50m, Draught: 6.30m, Service speed: 12 knots.

Octopus Onboard system – A modular decision support system developed by Amarcon BV for avoiding dangerous situations in adverse weather and sea conditions. The system combines information from wave measurements, weather forecasts, speed, course, route and the loading conditions to allow continuous monitoring of ship responses, possible hazards and their consequences. Octopus gives a warning, if and when a signal is expected to exceed the critical level, or when there is a risk of ship motion resonance. Clear guidance is given on how to find an operating point in which all the criteria are satisfied by changing the speed and/or course.

Officer – One of the certificated members of the ship staff who under the master authority assist him in navigation and operation of the vessel.

Officer of the watch, navigator – The person responsible for safe navigating, operating of the **bridge** equipment and manoeuvring of the ship.

Offset table – A booklet containing measurements, which are, taken from a faired **lines plan** to give the coordinates according to which the curved lines representing the hull must be drawn.

Offsets – A term used for the co-ordinates of a ship form, deck heights, etc.

Offshore – Industrial activity at sea, e.g. drilling and pumping at an oil or gas well.

Offshore Construction and Anchor Handling Vessel NORMAND INSTALLER

Designed by Wärtsilä Ship Design, an offshore construction vessel NORMAND INSTALLER was built in 2006 by Ulstein for the Norwegian offshore company Solstad Offshore ASA and the Swiss-based company Single Buoy Moorings Inc (SBM).

The vessel is employed in the installation and maintenance of floating production systems and single-point mooring (SPM) systems around the world. The vessel is thus designed to be extremely versatile in its capabilities based upon the experience of both Solstad Offshore and SBM, and upon anticipated future demands. It has the largest anchor handling winch ever supplied by Rolls-Royce, a moonpool, a 250t capacity A-frame over the stern, helicopter deck and a 250t offshore crane. It has a large working deck aft, with a working area of about 2500m² on two decks.

The vessel is equipped with a diesel-electric power plant incorporating two Wärtsilä 16V32 diesel generating sets and two Wärtsilä 8L32 diesel generating sets. The 16V32 engines each develop 7680kW, and 8L32 engines each 3840kW, both at 720 rpm. Electric propulsion motors drive through twin Wärtsilä SV105 reduction gears two Lips CPS115 controllable-pitch propellers (dia 4.5m) running in Wärtsilä Lips HR nozzles. In addition, Wärtsilä has delivered four CT250M-D tunnel thrusters and an FS225-240/MNR retractable thruster.

Length, oa: 123.65m, Length, bp: 110.00m, Beam, mld: 28.0m, Depth, mld to the main deck: 11.0m, Draught, scantling: 8.3m, Lightship mass: 10,574t, Deadweight at 8.2m: 9511dwt, Output: 2x7680kW + 2x3840kW, Speed: 16.8 knots, bollard pull: 275t, Accommodation for 100 persons.

OFFSHORE PRODUCTION AND STORAGE INSTALLATIONS

Depending of water depths, fixed or floating installations are used for offshore oil and gas production.

Fixed installation is a bottom-supported offshore facility permanently affixed to the sea floor. Fixed steel installations for oil and gas production are used at water depths ranging to about 150m. In most cases they consist of a jacket: a steel frame construction piled to the seabed. The jacket supports a sub-frame with production equipment and accommodation deck on top of it.

OFFSHORE CONSTRUCTION AND ANCHOR HANDLING VESSEL NORMAND INSTALLER

NORMAND INSTALLER is equipped with a complete Wärtsilä package including four diesel generating sets, two reduction gears, two controllable pitch propellers, HR nozzles, the propulsion controls, an advanced remote control system, four transverse thrusters and a retractable thruster.

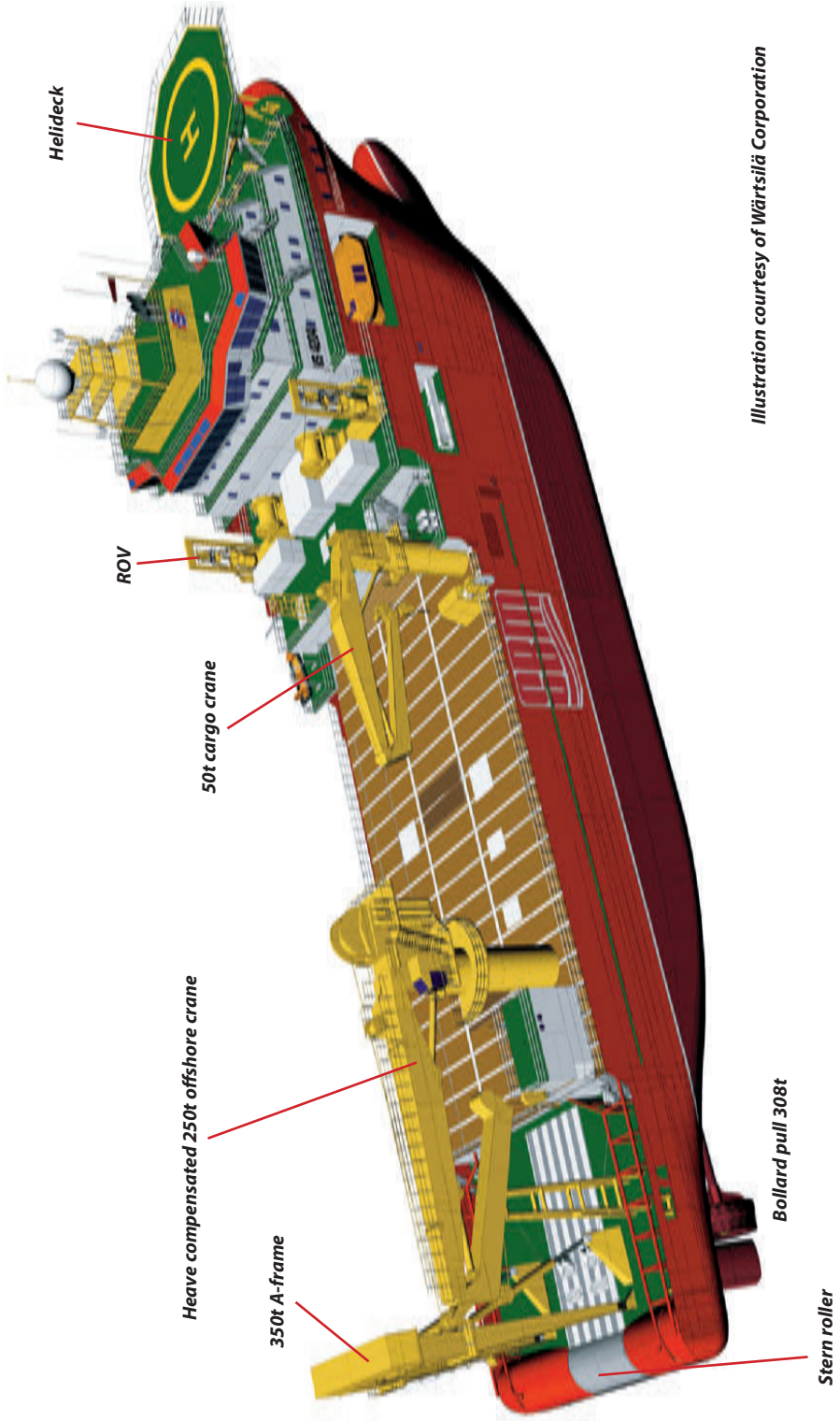
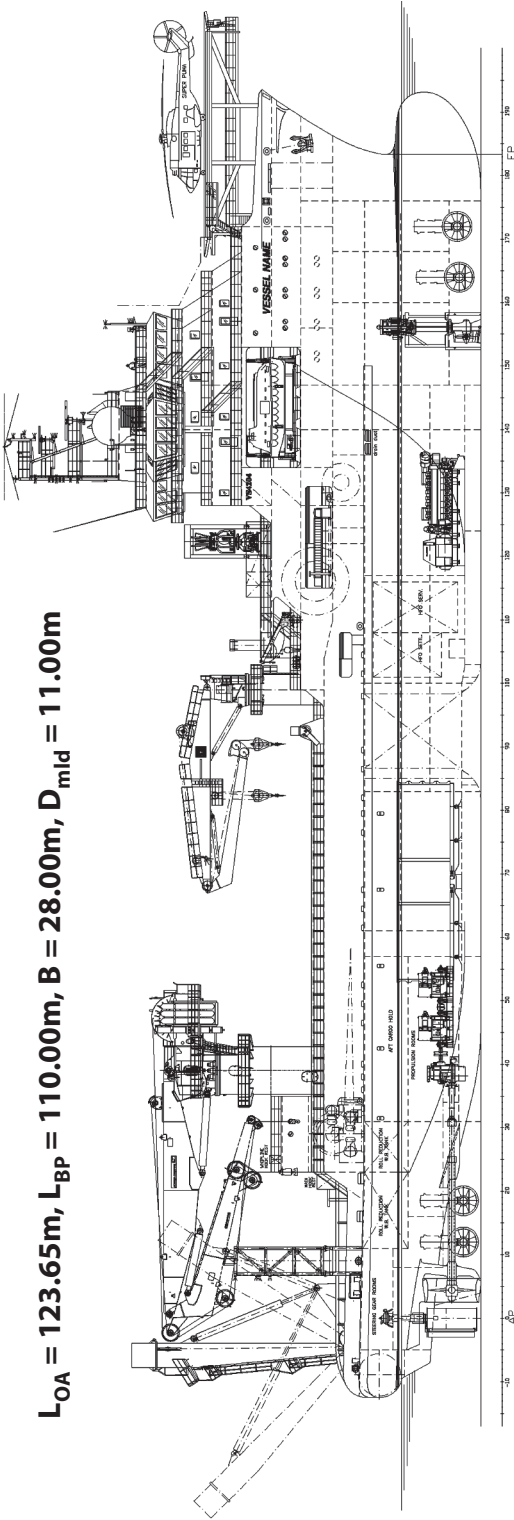

Illustration courtesy of Wärtsilä Corporation

OFFSHORE CONSTRUCTION AND ANCHOR HANDLING VESSEL NORMAND INSTALLER

$L_{OA} = 123.65\text{m}$, $L_{BP} = 110.00\text{m}$, $B = 28.00\text{m}$, $D_{mid} = 11.00\text{m}$



Illustrations courtesy of Wärtsilä Corporation

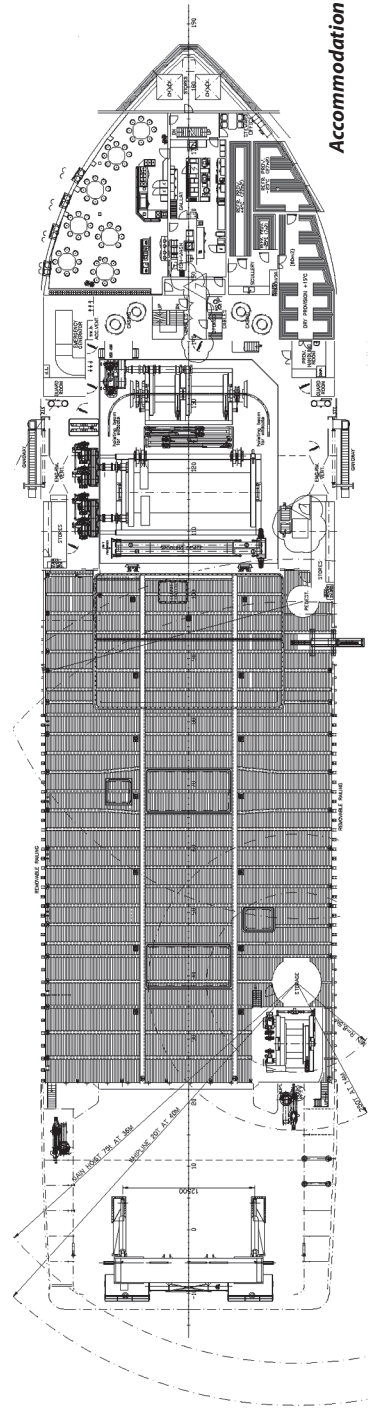

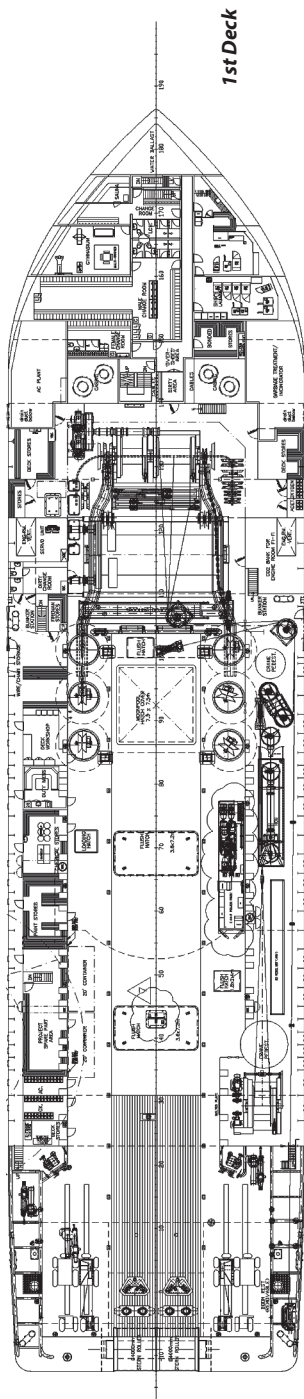

Illustrations courtesy of Wärtsilä Corporation

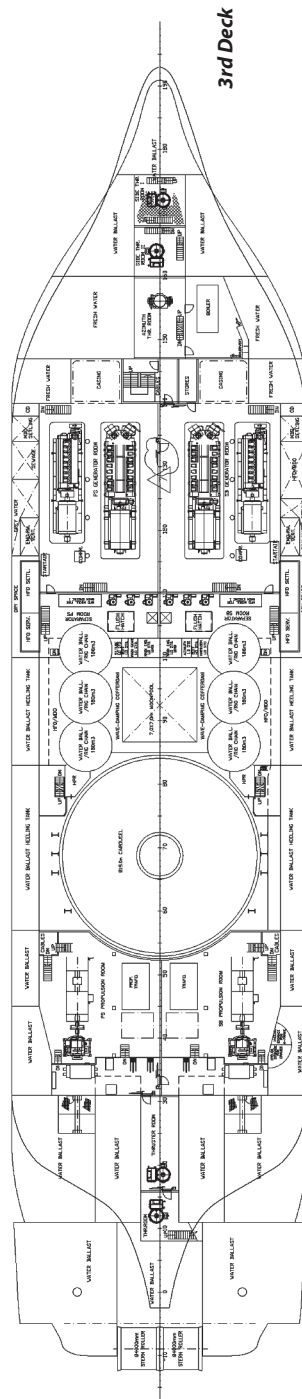
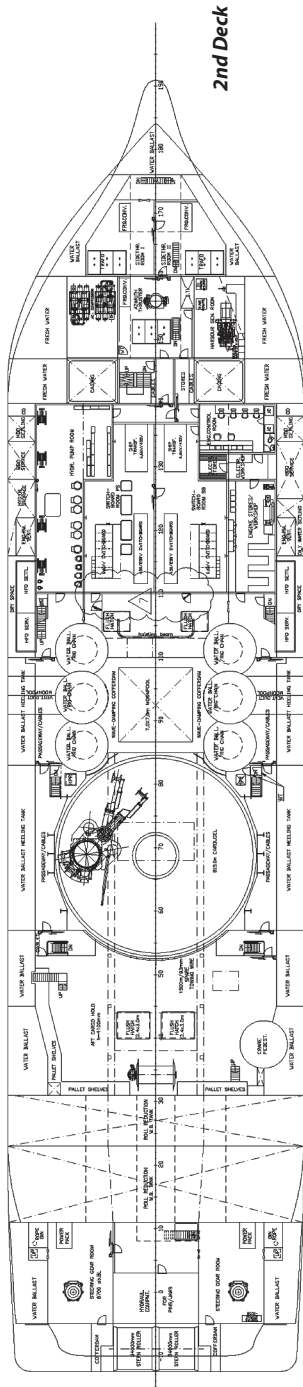

Photo Oyvind Hagen, courtesy of Statoil



Fixed steel installation on the Heimdal field

Photo Harald Petersen, courtesy of Statoil



Gravity Base Structure on the Heidrun field

Gravity Base Structures (GBS) are fixed installations applied to remote fields in deep and harsh waters in the central and northern part of the North Sea. They consist of a combination of a number of large diameter towers, placed on top of a large area base which contains also storage capacity. Pilling to the seabed is not required because of the large size of the base and the mass of the structure, but the sea-bed has to be levelled.

Floating installation is an offshore buoyant facility designed to provide **hydrocarbon** processing and/or hydrocarbon storage, and to off-load hydrocarbons. This installation is securely and substantially moored so that it cannot be moved without a special effort. The structural configurations of these installations may be ship-shaped or barge-shaped, column-stabilised, Tension Leg Platform Installations and Spar Installations.

Semi-submersible production installation is permanently moored by eight to twelve point catenaries. This installation processes and off-loads hydrocarbons without storage capacity. Motion of the semi-submersible does not allow wells to be completed on deck. So they are usually completed sub-sea. They are connected to the production wells through 4-inch to 12-inch diameter pipes know as risers. There can be as many as 60-70 risers connected to one platform.

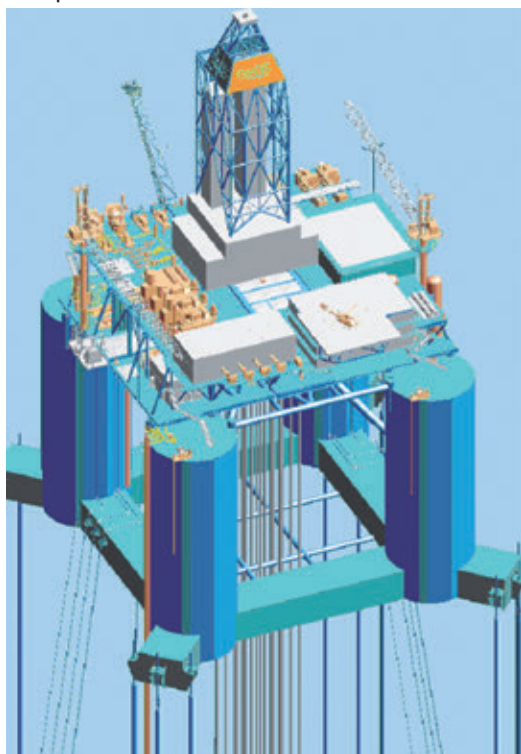

Tension leg platform

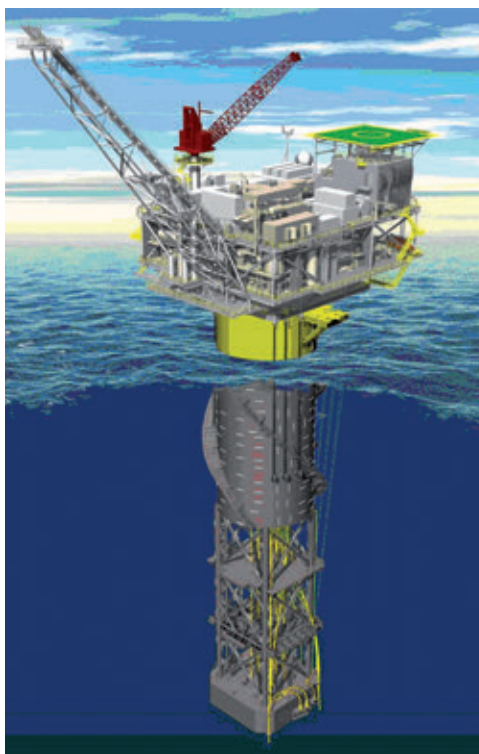

Truss Spar

Tension leg platform (TLP) consists of a semi-submersible hull vertically moored by an array of very stiff tendons held in tension by the buoyancy of the hull. The tendons, arranged at each corner of the hull, are connected to the columns of the hull and foundations on the seabed. The major advantage of a TLP is that the limited heave response allows for surface trees and rigid production risers.

OFFSHORE SUPPORT VESSELS (OSVs)

Spar platform consists of a single, vertical, large diameter cylinder that support the topside. The hull is moored as a taut catenary system of six or more lines anchored into the seabed. By virtue of a very deep draft, exceeding 200m, spars have significantly reduced heave response and like tension leg platforms, they can accommodate surface trees and rigid risers. When onboard storage is not required, the cylindrical midsection is replaced with a truss section. The truss spar offers a lighter and more cost-effective alternative while retaining the motion characteristics.

Photo Oyvind Hagen, courtesy of Statoil



FPSO PEREGRINO

Floating production, storage and offloading units (FPSOs) are ship-shaped structures used for exploitation of marginal fields. Their main advantage is that they are standalone structures that do not need external infrastructure such as pipelines or storage. The FPSO is a floating facility mainly installed near oil and gas production wells to receive, process, store, and export hydrocarbons. It consists of a tanker type hull or barge, often converted from an existing crude oil tanker. The wellheads or subsea risers from the sea bottom are located on a central or bow-mounted turret so that the ship can rotate freely to point into wind, waves or current. The main process is placed on the deck, while the hull is used for storage and offloading to a shuttle tanker.

OFFSHORE SUPPORT VESSELS (OSVs)

During the past decades the offshore oil and gas industries have expanded tremendously, which has led to ever increasing demand for offshore support vessels (OSVs) to carry out different operations necessary for floating drilling rigs, as well as moored or fixed production platforms. In order to encompass a more varied and multifunctional role, the facilities installed on board OSVs vessels have been revolutionized, so that they are now amongst the most technically sophisticated vessels afloat.

The OSVs can be divided into a number of types according to the operations they perform: seismic survey ships, platform supply vessels (PSV), anchor handling tugs, anchor handling tug and supply vessels (AHTS), offshore construction vessels (OCV), ROV support vessels, dive support vessels, stand-by vessels, inspection, maintenance and repair vessels (IMR) and variety of combinations of these.

Further reading: “*Offshore Support Vessels*”, see www.betterships.com

Seismic Survey Ship – A vessel mapping out geological structures in the seabed by firing air guns transmitting sound waves into the bottom of the sea. The echo of the shot is captured by listening devices/hydrophones being towed behind the vessel. Dedicated seismic survey vessels are highly specialised ships. The working decks are enclosed but typically are open at the stern and at a lower level, have the air gun handling system and storage, and at a higher level, they have winches and storage reels for streamers. The ship itself must be capable of accurate track and station keeping and the propulsion system must have low radiated noise and minimal propeller induced noise to avoid interference with the survey equipment.

See also **Seismic Ship GEO CELTIC**.



The general layout of PSVs has become fairly standardized, with a large open working deck aft and the accommodation forward. They have low angle of deck immersion due to small depth in way of open working deck

Platform Supply Vessel (PSV) – The PSV is designed for supplying offshore drilling rigs and production platforms with necessary equipment, stores and drilling consumables. These are typically cement, baryte and bentonite transported as dry powders; drill water; oil or water-based liquid mud, methanol and chemicals for specialized operations.

The PSV loads at a shore base. Liquid cargo is carried in double bottom tanks, dry bulk cargoes in special pneumatic pressure tanks, equipment and drill pipes on the aft open deck. At the rig or platform, the liquid and powder cargoes are pumped up or transferred pneumatically while deck cargo is handled by the rig crane.

A typical PSV operating profile shows the vessel spending about 25% of the time in harbour loading and unloading, 40% sailing at a service in the 14-16 knot range and 35 % loading or discharging at sea, often in strong winds, high seas and strong currents.

AHTS VS 490 NORMAND FERKING

$L_{OA} = 89.35\text{m}$, $L_{BP} = 79.35\text{m}$, $B = 22.00\text{m}$, $D_{mid} = 9.60\text{m}$

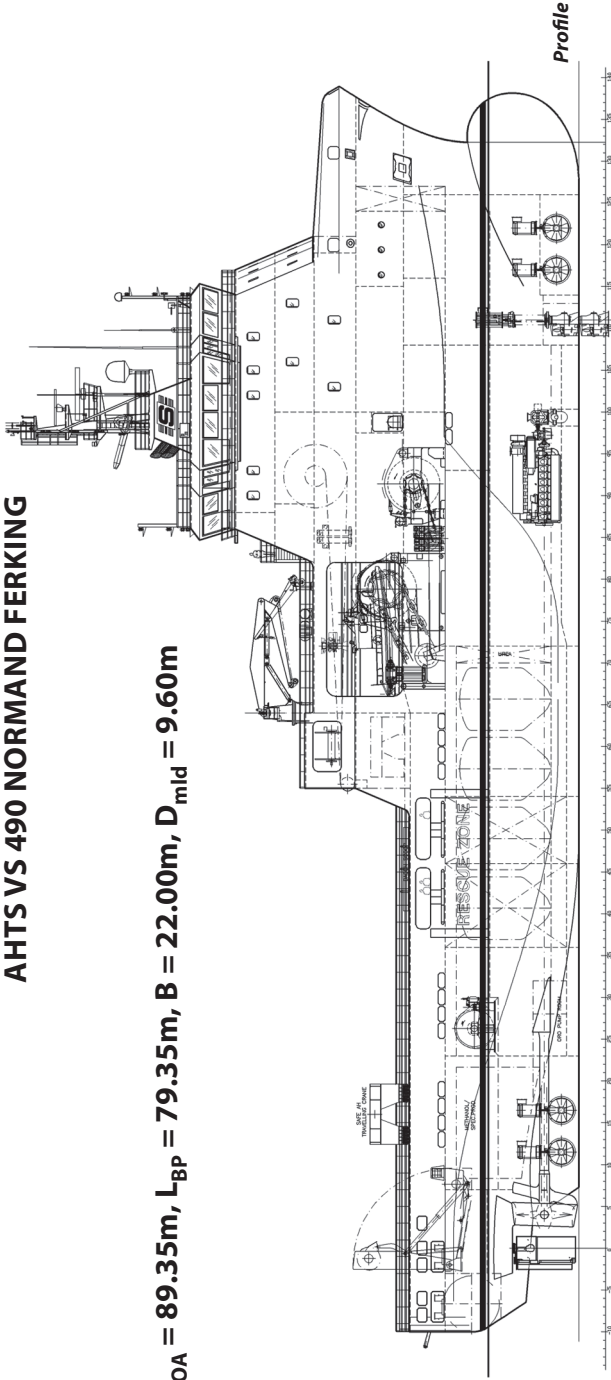

Illustrations courtesy of Wärtsilä Corporation

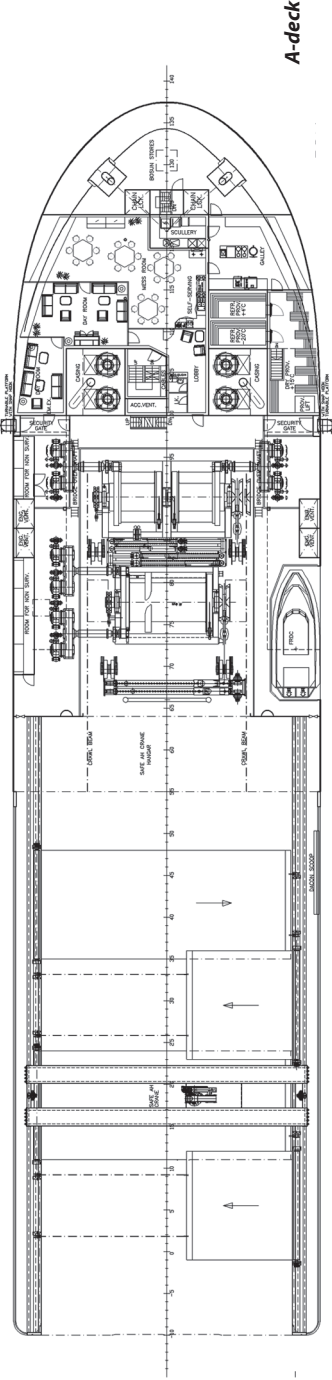

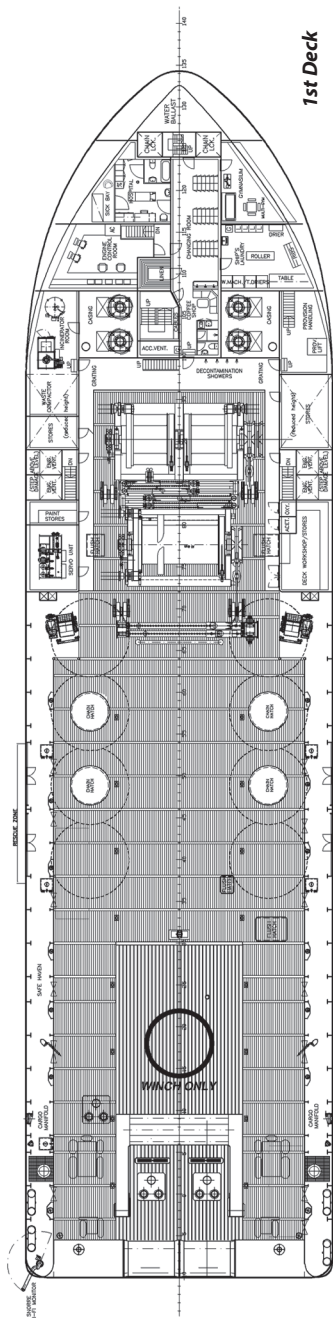

1st Deck

Illustrations courtesy of Wärtsilä Corporation

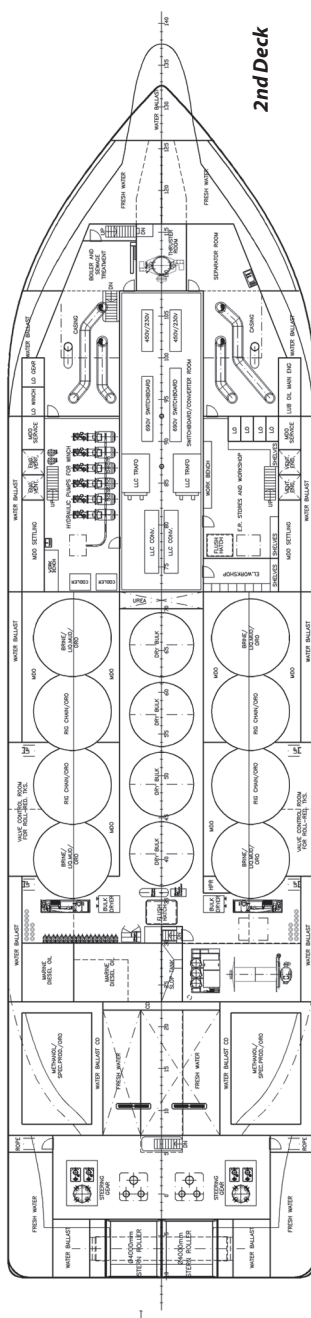

2nd Deck

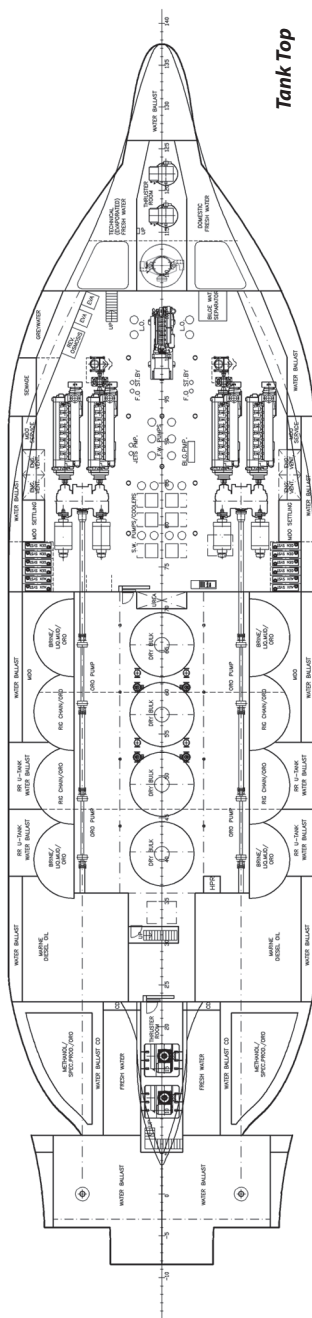

Tank Top

OFFSHORE SUPPORT VESSELS (OSVs)

The greatest dangers to a crewman working on a supply vessel include being washed overboard in bad weather conditions or being harmed – either by the cargo he is handling or by the equipment he is using. See also **Platform Supply Vessel VIKING ENERGY**.

Anchor Handling Tug Supply Vessel (AHTS) – The AHTS combines a number of functions in a single hull. These include handling the anchors and mooring chains for drilling rigs, towing of rigs and platforms together with subsequent positioning on site, and platform supply duties. The required **bollard pull** has a powerful influence on the design, since this defines the power need, the **propeller** size, hull shape and depth aft to give the necessary propeller immersion. Hull beam and shape shall give good stability, particularly when heavy moorings and anchors are suspended from the stern. Anchor handling requires high power, winch capacity, deck space aft, storage bins for rig chains and auxiliary handling equipment. A stern roller is used to ease the passage of wires and anchors over the stern of the vessel during deploying or weighing of the anchor. See also **AHTS Vessel SIEM PEARL**.

Illustration courtesy of Wärtsilä Corporation

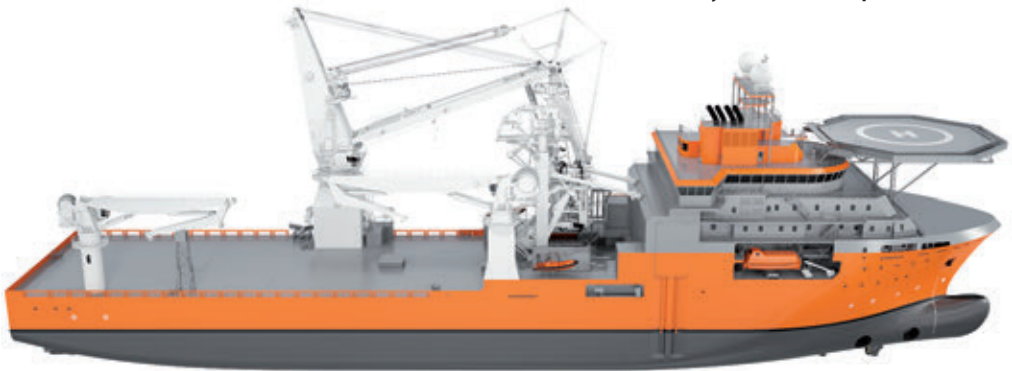

Heavy Construction Vessel

Construction Support Vessels – Dynamically-positioned Class 3 vessels with large unobstructed deck areas, substantial accommodation capacity and significant surface and subsea heavy lift crane capability, able to support surface and subsea construction and installation projects, as well as inspection, repair and maintenance (IRM) programmes. Construction Support Vessels are designed to provide tailored solutions and facilitate larger projects that often require such vessels to remain on location for long periods of time.

Illustration courtesy of Wärtsilä Corporation



Diving Support Vessel

OFFSHORE SUPPORT VESSELS



Seismic Ship



Platform Supply Vessel



AHTS



Offshore Construction Vessel



ROV Support Vessel



Diving Support Vessel



Well Intervention Ship



Emergency Response and Rescue Vessel

Diving Support Vessel (DSV) – A vessel provided with diving equipment and used for underwater work such as the maintenance and inspection of mobile platforms, pipelines and their connections, well-heads, etc. The DSV is fitted with a **moonpool** – a hole in the middle of the vessel open to the sea – through which divers, remotely-operated vehicles and other equipment is passed to and from the worksite. The DSV shall maintain an almost exact position over the worksite during diving operations. In order to accomplish this, it shall be provided with a DP3 class positioning system. See also **Diving Support Vessel SEVEN ATLANTIC**.

Inspection Maintenance and Repair (IMR) Vessel – A dynamically positioned ship-shaped offshore unit provided with equipment for well stimulation or maintenance (e.g. coil tubing). Such vessels are often able to carry out other tasks, such as **ROV** operations and general supply duties.

ROV Support Vessels – Dynamically Positioned (DP) Vessels from which ROV operations are conducted. ROV Support Vessels are equipped with computer-controlled, precision, position-keeping capabilities with added redundancy features, such as multiple computers, thrusters and reference systems. Such vessels have additional cabins, mess room facilities and Client offices, to comfortably accommodate the Client's ROV support crews.

Offshore unit – Any floating offshore structure (including vessels and barges), designed for operating afloat or supported by seabed.

Oil – Petroleum in any form including **crude oil, sludge**, oil refuse and refined products.

Oil clearance, oil recovery – An operation of removing oil from the water surface.

Oil Companies International Marine Forum (OCIMF) – The OCIMF is a voluntary association of oil companies interested in shipment and storage of **crude oil** and oil products. 27 Queen Anne's Gate, London SW1H 9BU, homepage: www.ocimf.com

The OCIMF published a large number of guidance notes and recommendations related to the operations of tanker ships.

Oil distribution shaft – It is a hollow propulsion shaft with the bore and radial holes used for distribution of hydraulic oil in **controllable pitch propeller** installations.

Oil-fired boiler MISSION™ OS boiler from Aalborg Industries

The MISSION™ OS boiler is a vertical oil-fired auxiliary boiler with a capacity range up to 6t/h. It is insulated and assembled as a unit with boiler mountings mounted on the boiler body. Basically, the boiler is designed as a vertical boiler with a shell surrounding a cylindrical furnace, and a convective section consisting of pin tube elements.

The pin tube elements consist of an outer tube enclosing the pin tube. A large number of pins are welded around the outside of the pin tube creating an extended heating surface. This surface transfers heat from flue gas to the steam/water mixtube in the pin tube.

The furnace floor consists of a steel plate protected from radiation of heat by refractory. The furnace bottom is provided with a socket for drain of washing water.

Oil ignition and combustion take place in the furnace. The produced heat is transferred mainly by radiation from the flame to the furnace shell. Leaving the furnace, the flue gases flow through the vertical uptakes where heat is transferred to the pin-tube elements mainly by convection.

On the water side, the heat is transferred by evaporation of the saturated water adjacent to the furnace shell or tube wall where steam bubbles are formed. As the steam bubbles have a much lower specific density than the water, they will rise rapidly to the steam space where water and steam are separated.

The natural circulation in the pin-tube elements occurs because the density of water is higher than density of steam. The density of the water outside the pin-tube element is higher than steam/water mixture inside the pin-tube element. The difference in the static pressure at the lower connection to the pin-tube creates the driving force for the circulation. The steam/water mixture is discharged into the steam space where the heavier water particles separate from the steam and flow back into the water.

The steam space is designed to absorb the shrink and swell volumes. It is very important to note that a boiler plant consisting of one or more exhaust gas boilers using the steam space in the MISSIONTM OS boiler is not designed for simultaneous operation.

For further information visit www.aalborg-industries.com

Oil-in-water monitor – A measuring instrument which determines the contents of oil in bilge water. If the permitted level is exceeded, an alarm is activated and the water flow is directed to a slop tank. See also **Oily Water Separator**.

Oil Pollution Act (OPA) – The American rules on the safety of transport of **hydrocarbons** by sea. Provisions apply to tanker structure, with the requirement that new tankers should be built with a double hull or other similar design. It also introduces a tougher inspection system of existing ships, making it obligatory for ships to have an emergency action plan on board.

Oil Record Book – The document required to be carried on board ships by **MARPOL 73/78**, Annex I, reg. 20. Every **oil tanker** of 150 **gross tonnage** and above and every ship of 400 gross tonnage and above, other than oil tanker, shall be provided with an Oil Record Book, Part I (Machinery space operations).

Every oil tanker of 150 gross tonnage and above shall also be provided with an Oil Record Book, Part II (Cargo/ballast operations).

Oil recovery and sludge treatment system – A system designed to handle sludge from oil treatment systems in diesel engine installations. The system separates the sludge into its three main components: oil, sludge and water. The recovered oil is fed to a boiler feed tank, the concentrated separated sludge is fed to a sludge tank for disposal and the water proceeds to the **oily water separator**.

Oil recovery system of HAVEN HORNBILL

According to **Significant Small Ships** of 2002

Halmatic Ltd delivered a multi-role oil spill recovery vessel HAVEN HORNBILL for Harwich Haven Authority in July 2002. Oil spill recovery equipment comprises a complete LORI oil recovery system with four brushes to port and starboard. Oil recovery channels are incorporated in both sides of the vessel outboard midships – compartments are 4.8m long and 1.2m wide – casings are built on the main deck with top-opening hatches for maintenance and removal of equipment.

For separating oil and debris the recovery channels are fitted with standard LORI brush packs, each with four brush chains mounted in aluminium alloy frames, approximately 3.5m long. The brush is cleaned by a comb installed at the upper end. It discharges oil and debris into a collection hopper.

Oil slick

The recovered oil is dropped from the brushes into the collecting sump from where it is transferred to recovery tanks via two Desmi model DOP-250 heavy duty submersible, hydraulically-powered pumps, complete with cutting knives for debris.

An oil-skimming boom can be rigged on both sides of the vessel and the height of the boom is tapered outwards with adequate height close to the vessel, compensating for roll and pitch. The inner end is attached to the aft door and the forward end is supported by the outboard end of the side jib.

Oil slick – A layer of oil floating on the surface of the sea, generally caused by accident or spillage.

Oil spill combatment vessel ARCA

According to **HSB International** June 1998

Built by Damen Shipyards, The Netherlands, the ARCA is multifunctional vessel with oil recovery as the main function, but she is also able of carrying out hydrographic survey and research work. The ARCA can process and transport up to 1000 m³ of recovered oil. The vessel is equipped with two 15m long retractable oil booms. With the sweeping arms the ARCA can embank an **oil slick**, sweep it together, pump it up, separate it and take it with her. Each sweeping arm is fitted with an inner pontoon accommodating the hydraulically adjustable pump skimmer housing and a movable dirt grating. The inner pontoon is, just like the outer pontoon, fitted with three fenders, bollards, a catwalk and a footrail. Below decks, inflatable booms of 2 x 200m are carried on a hydraulic reel system. The vessel also carries various types of oil skimmers and a demulsifier and gas oil injection system. A small **workboat** is fitted on board for pulling the inflatable booms. A helium balloon with camera is utilised to determine the extent of the oil spill slick with a bird's eye view.

Length, oa: 83.00m, Beam: 12.80m, Depth: 7.00m, Design draught: 4.50m, Draught maximum: 5.50m, Deadweight max: 2000dwt, Propulsion power: 2 x 1230kW.

Oil spill response vessel (OSRV) – A ship designed to support oil spill clean-up operations by oil recovery, boom deployment and/or dispersant application. Oil recovery ship is equipped with fixed installations and/or mobile equipment for the removal of oil from the sea surface and its retention on board, carriage and subsequent unloading. Boom deployment vessels install floating barriers (booms) to control spilled oil. They frequently feature reels for stowage of boom. Dispersant application vessels are fitted with pumps and distribution systems.

Oil spill response vessel ARKONA

With the Spill Response Vessel for the Federal Ministry of Transport, Building and Housing the German shipyard Peene-Werft GmbH delivered another highly- sophisticated ship. The multi-purpose vessel is ready for duties within the framework of the maritime emergency response in the North and Baltic Sea for fighting against oil- and chemical spills and for executing emergency towing operations in the Baltic Sea. Furthermore, the concept includes an engagement in icebreaking, handling seamarks and fulfilling tasks of the shipping police.

The ambitious profile of the vessel is reflected by its class notation:

GL ❄️100 A5 E3 ❄️MC E3 AUT RP2 50% Oil Recovery Vessel, Chemical Recovery Vessel, Tug, Icebreaker

For the intended purpose the vessel is equipped with special winches, boats, cranes, skimmers, separation plants, cargo tanks and fire-fighting systems. Operation in anti-gas

mode is possible by means of the installation of special diesel engines and the arrangement of a citadel.

The diesel-electric propulsion system comprising two Schottel Electric Propulsors of 1850kW each and a Schottel Pump-Jet of 1000kW provides the vessel with a speed of 13.1 kn, a bollard pull of 400 kN and the required good manoeuvring features.

Modern radio, communication and nautical plants are fitted. Together with a horizontal log

Picture courtesy of Peene-Werft and Fotostudio Wasmund, Wilhelmstrasse 54, 17438 Wolgast



and five computer working stations interlinked via LAN, the set duties can be fulfilled in an optimal way.

Dimensions:

Length o.a.: 69.20m, Length b.p.: 66.40m, Breadth mld:14.50m, Depth: 5.50m, Design draught (Buoy Layer): 3.80m, Max draught: 4.50m

Deadweight: 895t at max draught and 277t at design draught

Measurement: 2056 GT

Speed: 13.1 kn (at T design , 100% MCR)

Bollard Pull: 400kN

Icebreaking (at v=5 kn) up to 0.5m

Main Propulsion: diesel-electric, 2x 1850kW podded drives SEP2

Main Engines: 4x MTU 12 V 4000 M50A GSB, 1140kW at 1500 rpm, each

Auxiliary Engines: 1x of MTU S 60 6062 HK 51 KC, 298kW, 1500 rpm

Bow Thruster: 1x pump jet SPJ 220L, 1000kW

Complement: 16 crew, total number of berths 32 pcs.

Stores:

Fuel oil	275m ³	Fresh water	30m ³
Cargo tanks	408m ³	Ballast water	276m ³
Slop tank	35m ³	Fire-fighting foam	19m ³

OIL SPILL RESPONSE VESSEL ARKONA

**$L_{OA} = 69.20m, L_{BP} = 66.40m,$
 $B = 14.50m, D_{mid} = 5.50m$**

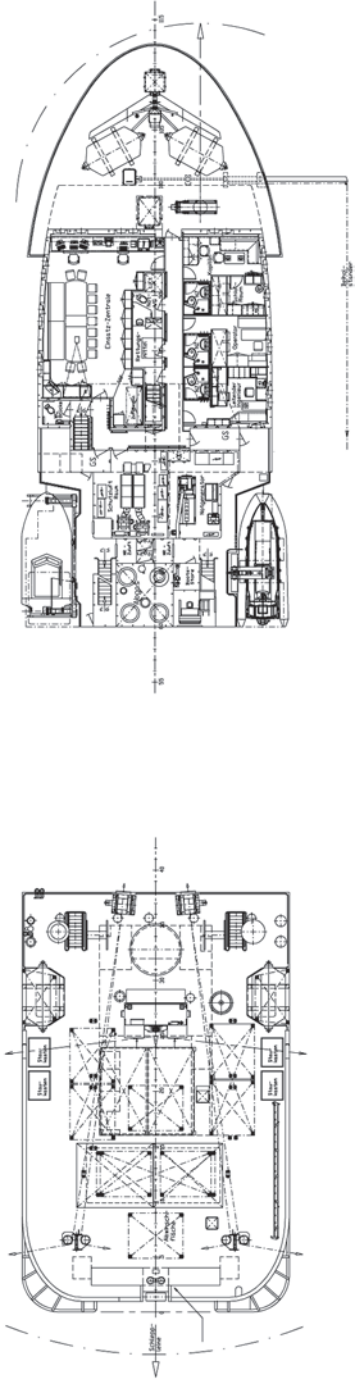
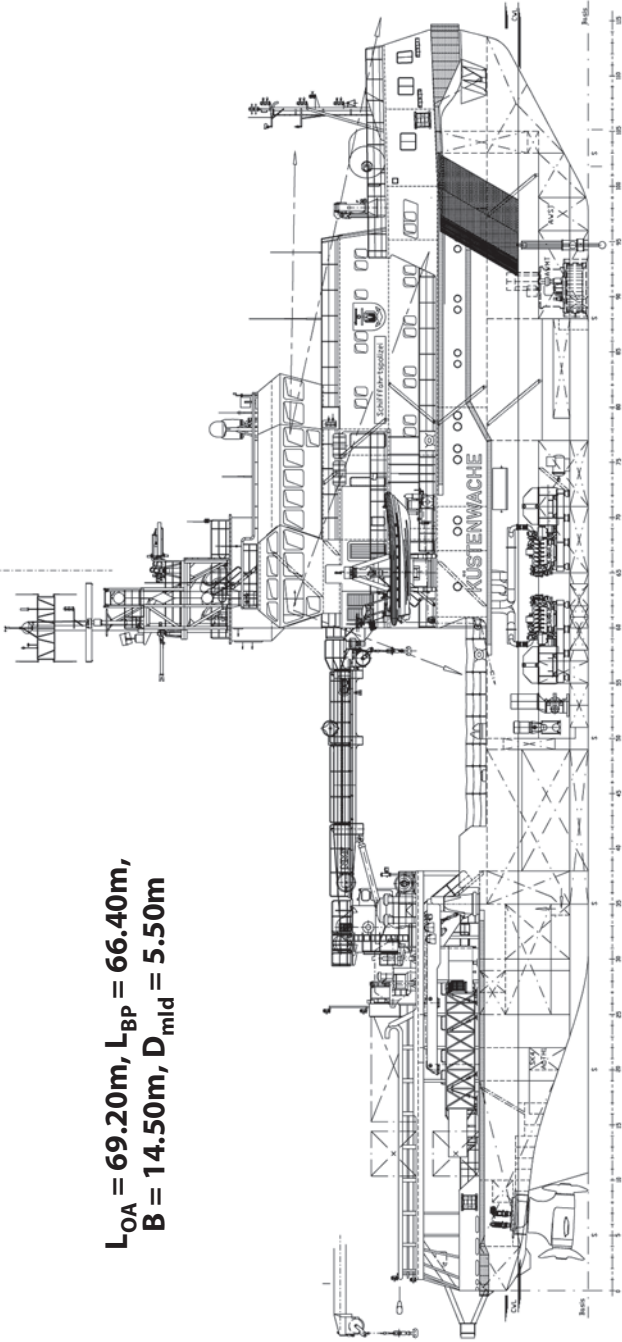

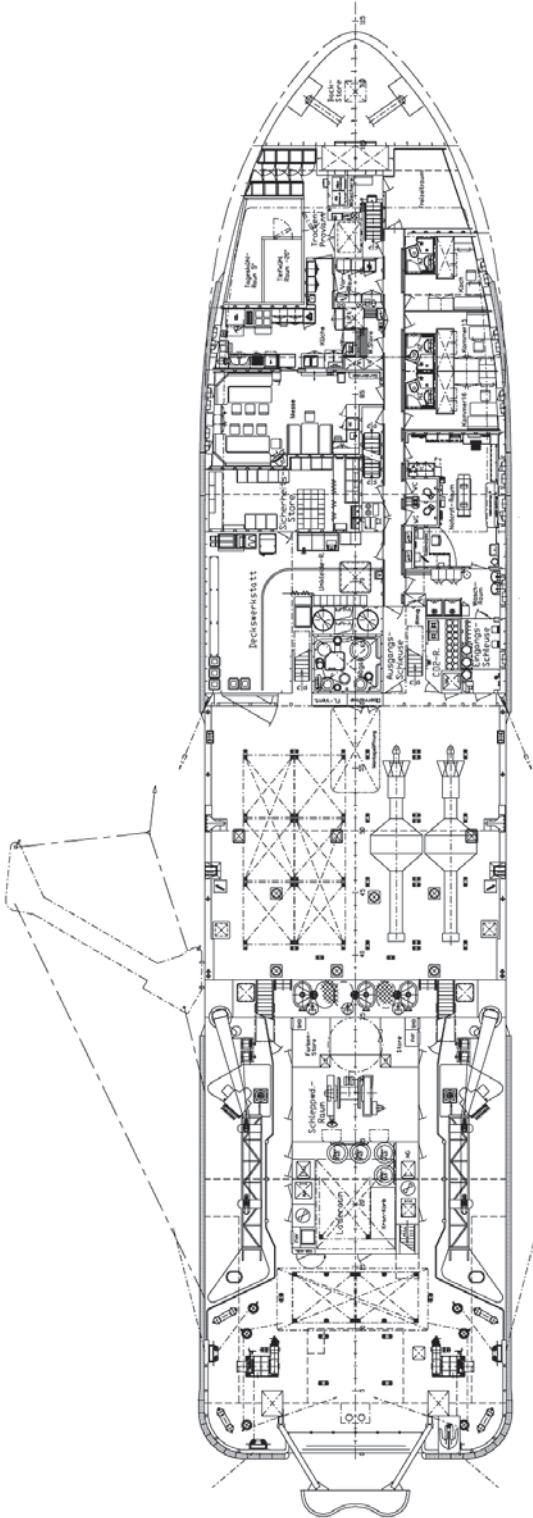

Courtesy of Peene-Werft

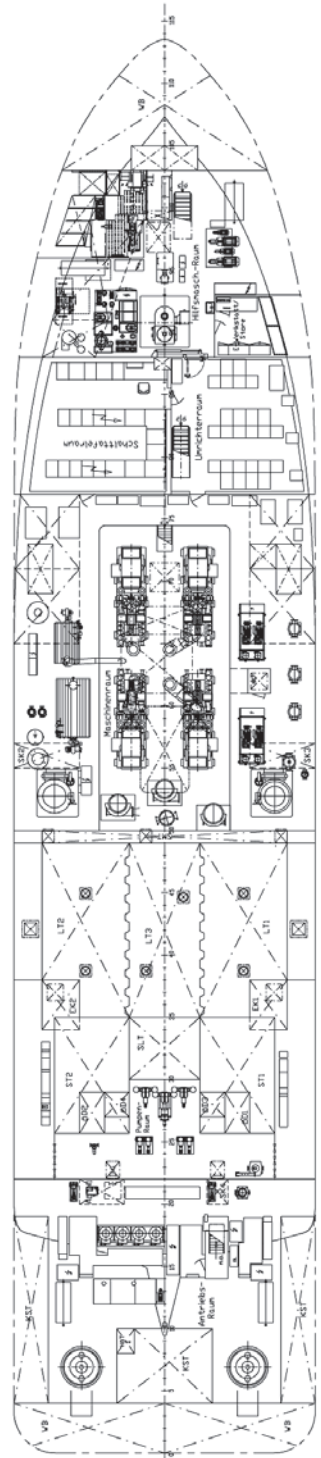



Photo courtesy of Peene-Werft and Fotostudio Wasmund, Wilhelmstrasse 54, 17438 Wolgast

Equipment:

2 pcs. of skimmers with high pressure hot water cutting system, launching/towing devices for skimmer,

2 pcs. of separation plant, 320 m³/h oil-water mixture,

emergency towing gear with winch, warping capstan, hydr. karm fork/towing pins unit,

fire-fighting equip. with 2 monitors – 600 m³/h, water/foam monitor – 400 m³/h, portable monitor and jet-pipe, self-protection sprinkler system,

gas warning and analysis units, gas filtration plant,

Seamark handling equip. with crane 12.5t/22m, working winches and echo ranging set.

Oil tanker – A ship constructed or adapted primarily to carry oil in bulk in its cargo spaces.

This includes **combination carrier** and any **chemical tanker** when they carry a cargo or part cargo of oil in bulk.

Beam and draft restriction have led to a few preferred sizes of oil tankers:

About 35,000-45,000dwt: Panamax tankers configured for transit through the Panama Canal when loaded to their design draft.

About 70,000-120,000dwt: Aframax tankers.

About 120,000-165,000dwt: Suezmax tankers, they may be arranged for multiple grades (three segregated grades is common).

About 200,000-310,000dwt: Very Large Crude Carriers (VLCC) designed for the carriage of crude oils on longer voyages.

About 310,000-550,000dwt: Ultra Large Crude Carriers (ULCC).



Type	Panamax	Aframax	Suezmax	VLCC	ULCC
Ship	MILTADIS	NEVSKIY PROSPECT	NORDIC STAVANGER	LIMBURG	HELLESPOINT ALHAMBRA
Length, oa	228.00 m	249.90 m	277.40 m	332.00 m	380.00 m
Length, bp	219.00 m	239.00 m	262.00 m	320.00 m	366.00 m
Breadth, moulded	32.24 m	44.00 m	46.00 m	58.00 m	68.00 m
Depth, moulded	20.40 m	21.00 m	23.60 m	31.00 m	34.00 m
Draught design	12.22 m	12.20 m	15.85 m	20.80 m	23.00 m
Draught scantling	13.80 m	14.80 m	17.00 m	22.00 m	24.50 m
Deadweight design	60,750 dwt	89,034 dwt	134,600 dwt	278,95 dwt	407,469wt
Deadweight scantling	71,522 dwt	114,680 dwt	147,500 dwt	299,364 dwt	441,893 dwt
Gross tonnage	41,787	62,586	80,691	157,833	234,006
Displacement		133,280 t		341,097 t	509,484 t
Lightweight		18,600 t		41,732 t	67,591 t
Cargo capacity	85,285 m ³	130,016 m ³	162,781 m ³	347,593 m ³	513,684 m ³
Width of side structure	2.08 m	2.20 m	2.55 m	3.52 m	3.90 m
Bottom height	2.05 m	2.38 m	2.80 m	3.00 m	3.30 m



Oil treatment – The preparation of fuel oil or lubricating oil for use in a diesel engine. It involves storage and heating to allow separation of any water present, coarse and fine filtering to remove solid particles and also centrifuging to further clean the oil.

Oil/water interface detector – A sensor which must be fitted in oil tanker slop tanks. During pumping of the slop tank, it determines the interface level at a low position and stops further discharge.

Oily mixture – A mixture with any oil content.

Oily rags – Rags that have been saturated with oil. Contaminated rags are those, which have been saturated with a substance defined as a harmful substance in Annexes to **MARPOL 73/78**.

Oily water separator, bilge water separator – A device used to separate oil from oily water mixtures and from the emulsion. Bilge separators are necessary aboard vessels to prevent discharge of oil overboard while pumping out bilges or while cleaning oil tanks. An oil-content monitor is provided to measure continuously the oil content of the effluent. If the set limit of the oil content is exceeded, the effluent is automatically recirculated to the collecting tank, or the separator is stopped. Many conventional oily water separators fail to split stable emulsions and remove suspended colloidal particles from the water phase. This often results in equipment malfunction because the separation of oil below 15 ppm is not achieved or because of clogging from excessive solids.

15 ppm bilge separator – Any combination of a separator, a coalescer or other means, and also a single unit designed to produce an effluent with oil content not exceeding 15 parts of oil per million parts of water by volume.

Note:

According to Resolution MEPC.107(49), a sampling point should be provided in a vertical section of the water effluent piping as close as practicable to the 15 ppm bilge separator. Re-circulating facilities should be provided after and adjacent to the overboard outlet of the

WÄRTSILÄ OILY WATER SEPARATOR

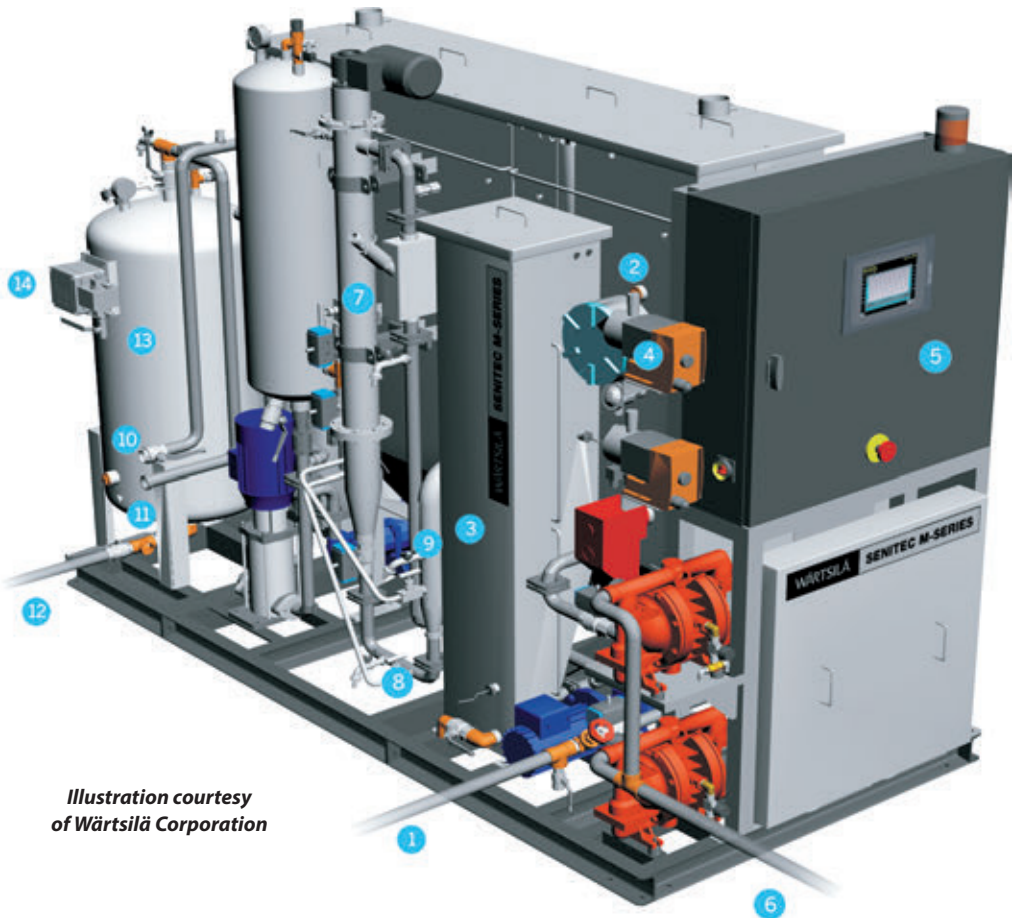

Illustration courtesy
of Wärtsilä Corporation

Oily water separator WÄRTSILÄ SENITEC M1000, capacity 1 m³/hour

The Wärtsilä Senitec oily water treatment units use optimized emulsion breaking and separation technology that surpasses all existing regulations and guarantees an oil content in the cleaned water of below 5 ppm. In normal operation the actual levels have repeatedly been shown to be as low as 1 ppm, which gives a priceless safety margin to the IMO limit.

- | | |
|----------------------------|---|
| 1. Bilge water inlet | 8. Dissolved air inlet |
| 2. Oil separation stage | 9. Inlet to flotation stage |
| 3. Emulsion tank | 10. Overboard |
| 4. Chemical dosing pumps | 11. Backwashing water outlet |
| 5. Control panel | 12. Fresh water inlet (to filter stage) |
| 6. Oil and solids effluent | 13. Filter stage |
| 7. Chemical stage | 14. Oil monitor |

Further reading: Wärtsilä Environment Technologies Product Guide

One compartment subdivision

stopping device to enable the 15 ppm bilge separator system, including the 15 ppm bilge alarm and the automatic stopping device, to be tested with the overboard discharge closed. One of the main causes of oilywater filtering equipment malfunction is the effect of bilge water containing cleaning agents. Detergent-based cleaning fluids can produce chemically stabilised oil emulsions which cannot be separated on board ship by the gravity alone. The best way to improve the performance of oily bilge water separating equipment is to avoid the use of surfactant-based cleaning materials.

One compartment subdivision – A standard of subdivision of a ship by bulkheads, which results in the ship remaining afloat with any one compartment flooded, under specified conditions as to the **permeability** of the compartment and the draft of the ship before flooding of the compartment.

On-hire/off-hire surveys – Surveys carried out to state the ship condition prior to or after her chartering. The main purpose is to record deficiencies or damages.

On-load release hooks – On-load release mechanisms designed to permit the release of the davit-launched lifeboat from fall wires when ship is still making way through the water or in rough sea. There is a common misconception that the on-load release system is to allow a lifeboat to be release while suspended from the fall wires. This is very dangerous practice, which can result in serious spinal injuries to persons on board and significant damage to the boat.

Since their introduction, failures of on-load release hooks were reasons of many serious accidents. There are reported to be about 80 types of on-load release hooks in service. Some of these systems are described by accident investigators as “inherently unsafe” or “unstable”. Many of the original manufactures of these systems are no longer trading and this leads to a situation where spare parts are not available creating problems with proper maintenance.

Remember:

It is not allowed to “drop” the davit-launched lifeboat from the falls to the water, as when the lifeboat is dropped, even from as little as one metre above the water, there can be serious personal injuries and possible structural damage.

Testing the on-load release mechanism must be carried out by equipment manufacturers or their authorized representatives.

On-scene commander (OSC) – The commander of a rescue unit designated to co-ordinate search and rescue operations within a specified area.

Open bell – A non-pressurized compartment at ambient pressure that allows the **diver** to be transported to and from the work site. It allows the diver access to the surrounding environment, and can be used as a refuge during diving operations. See also **Diving bell**.

Open sea – An ocean or sea outside territorial limits, i.e. international waters.

Open-top container vessel RIJNBORG

According to **HSB International** December 2006

Built by IHC Holland Dredgers BV Shipyard the RIJNBORG is the open top cellular container carrier with a capacity of 1700TEU. This type of vessel is characterized by the absence of hatch covers, allowing fast loading and unloading. Perhaps the most novel feature is the propulsion plant formed by a pair of new Wärtsilä medium speed diesel engine 6L46F. The new type engine features improved dual high pressure pump fuel injection and an integrated automation system resulting in better fuel economy and lower emissions.

The main engines are coupled to a twin input/single output reduction gearbox. This 42.5 ton heavy unit has its input shafts 3300mm apart and the output shaft in between. The gearbox also features a vertically offset power take off (PTO) for the shaft generator. The output of the gearbox goes to a controllable pitch propeller with diameter 5350mm. Each input shaft is fitted with a hydraulically operated multiple disk type clutch; one main engine can remain on standby, while the other is running near its optimum rate. This propulsion arrangement allows for economic and more ecologic running at an wide range of ship loadings.

Also located in the engine room are two diesel driven generator sets, each rated at approx. 1288kVA. The shaft generator driven through a PTO is rated at approx. 2500KVA. This high power demands stems mainly from the 200 reefer containers, each rated at 11kW.

On board there are three power systems. An AC three-phase 480V – 60Hz circuit provides for the heavy consumers, such as pumps, ventilators and the bow thruster. An AC 230V – 60Hz circuit supplies the lighting installation and other domestic costumers. Finally a 24V DC circuit supplies the alarm system, control systems and other applications.

Length, oa: 176.00m, Length, bp: 166.50m, Breadth, mld: 23.70m, Depth, mld: 11.00m, Draught: 7.70m, Deadweight: 16,450dwt, Container capacity: 1700TEU, Propulsion power: 15,000kW, Service speed: 19 knots.

Open-top reefer container vessel DOLE COLOMBIA

In the middle of 1990's, Dole Fresh Fruit International looked for vessels able to transport 1000 reefer 40ft containers. Gdańsk Shipyard, which built a lot of reefer vessels for Dole, convinced Dole's technicians to adopt open-top configuration for new ships. However, diesel-electric propulsion and a forward accommodation block were too innovative for them. As a consequence, the contract was signed with Howaldtswerke-Deutsche Werft (HDW) in Kiel, which designed an open-top vessel with classic mechanical propulsion and huge electric plant used mainly during a short period of cooling-down. Two reefer container vessels: DOLE CHILE and DOLE COLOMBIA were delivered in 1999.



Open water efficiency

The vessel has 6 holds with 10 bays. Only the first hold is fitted with hatch covers. The open-top cargo holds are equipped with cell guides up to 10th tier; containers are stowed 11 high and 11 across. DOLE COLOMBIA can carry 990 refrigerated FEUs: 851 in open-top holds, 95 in the conventional Hold N°1 and 44 on its hatch cover. All reefer containers have both, air-cooled and water-cooled condensers. The containers inside holds are cooled by the water-cooled condensers connected with the fresh water cooling system by quick coupling pipe connections. The holds are equipped with mechanical supply and natural exhaust. Air is lead to the bottom of the cargo holds to ensure the proper circulation.

Some holds have been prepared to enable reefer containers to be carried under modified atmosphere to slow the fruit ripening process. A membrane type nitrogen generating plant from Unitor is installed on board. The unit consists of two screw compressors and auxiliary components for air treatment, such as oil and water separators, filters and heaters. The heart of the system is the membrane unit which consists of several parallel hollow fibre membranes. Nitrogen is distributed to the holds through an extensive piping system, which ensures a precise and pre-determined amount of nitrogen to be delivered to each container.

Loading and unloading is done by two gantry cranes from Liebherr, driven along rack-and-pinion tracks. They consist of a central carrying crossbeam on two supports with a traveling trolley lifting system. The crossbeam is provided with swing-out extensions on both sides. These extensions enable the crane trolley to move out on a fixed support 10m over each of the ship sides.

Propulsion power is provided by a Wärtsilä 8RTA 72U two-stroke diesel engine with 23,920kW output at 97rpm. The direct driven fixed-pitch propeller has 6 blades and a diameter of 6.65m. To optimize manoeuvring capabilities, the ship is equipped with both a bow and stern thrusters, each with an output of 1450kW.

Electrical energy is provided via 5 diesel generators with the total power of 20,930 kVA similar to a power plant able to supply a small city. The main board network is a 6.6 kV medium- voltage system. The main consumers such as: thrusters, transformers for reefer containers, MA compressor distribution and the 440V main switchboard are supplied from the 6.6kV switchboard. The 440V distribution switchboards, which provide power to container plugs, are located in the passageways close to the holds. The switchboards are supplied from 6.6 kV water-cooled transformers located also in the passageways. The spatial arrangement of the switchboards and transformers involves a lot of the detailed solutions in order to accommodate them in the confined spaces of the passageways.

Length, oa: 204.90m, Length, bp: 193.40m, Breadth, mld: 32.24m, Depth, mld: 20.80m, Draught design/maximum: 9.25/10.20m, Deadweight design/maximum: 25,055/30,560dwt, Gross tonnage: 34,840, Propulsion power: 23,920kW, Service speed at 87.7% MCR: 21 knots.

Open water efficiency – The ratio of the **thrust power** to the power absorbed by the **propeller** operating without a hull attached, i.e. in open water.

Openings – The external openings may be listed into the following categories, depending on their means of closure: unprotected, weathertight, watertight. Only watertight openings do not lead to **progressive flooding**.

Operating values of an engine – Engine data, like cylinder peak pressure, exhaust gas temperature, etc., from the engine log which are related to the **NOx emissions** performance.

Operation manual – An instruction book provided by manufacturer, which details the correct operating procedure for a piece of equipment.

Operational – Ready for immediate use.

Operational design – Operational design is that part of the design process, which ensures that the crew and stevedores can operate a ship effectively. It covers the concept of the ship at sea, controllability, workability, manoeuvrability, security, safety and emergency response, maintainability and **habitability**.

Operator – A person, a company, or a government agency, or a representative of a company keeping operational control over a **terminal**.

Ore carrier – A single-deck **bulk carrier** having two longitudinal bulkheads and a deep double bottom throughout the cargo region and intended for carriage of ore cargoes in the center holds only. The cargo hold capacity has commonly been based on stowage factor of 19.5 to 21.5cbf/ts at summer draught. These specially designed dedicated vessels spend much of their voyage time in ballast since they do not carry any cargo on the back haul.

Ore/oil carrier – A combination carrier similar in construction to an ore carrier but also features side tanks for the carriage of oil. These ships do not carry ore and oil simultaneously. In the mid-1970s, a number of up to 280,000dwt ore/oil carriers were built. Since then, only a few such vessels have been built and today the majority of them are employed in trading only dry cargo as they are no longer certified for the carriage of oil.

Orimulsion – An emulsion containing 70% of natural bitumen finely dispersed in water and stabilised by a package of additives. The bitumen is extracted in a Venezuelan region known as the Orinoco Belt.

Osmosis – The diffusion of a solvent through a semi-permeable membrane which separates two solutions of different concentrations, such that the concentrations are equalized.

Reverse osmosis – The use of a high-pressure pump to force a liquid through a semi-permeable membrane which stops salts or dissolved solids. It is a means of producing distilled water from seawater.

Outboard – In a direction away from the centerline of the ship.

Overall survey – A survey intended to report on the overall condition of the hull structure and determine the extent of additional **close-up surveys**.

Overflow – Accidental escape of oil from a tank when it gets too full because pumping was not stopped in time.

Overflow pipes – Pipes provided to prevent, during filling operations, an overload greater than the one corresponding to the test pressure prescribed for the compartments.

Overflows prevent over-pressurisation of a tank if it is overfilled and also provide for safe discharge or disposal of the overflowing liquid.

Overhead welding position – The welding position in which welding is performed from the underside of the joint.

Overload – A load which is in excess of the rated capacity of the unit or device, e.g. an engine, motor, electric cable.

Overload protection – A device which interrupts the current flow if it reaches an excessive value.

Override – A manual means of changing the operation of an automatically-controlled device or a system.

Overspeed protective device – Each main propulsion engine which can be declutched or which drives a CP **propeller** is to be fitted with an overspeed device so adjusted that the speed cannot exceed the maximum rated speed by more than 20%.

Oxygen

Oxygen – A colourless, odourless gas which occupies about 20% of the atmosphere. It is essential for support of combustion and all forms of life.

Oxygen analyser/meter – An instrument for determining the percentage of oxygen in a sample of the atmosphere drawn from a tank, pipe or compartment.

Oxygen cutting – A group of thermal cutting processes that separates or removes metal by means of the chemical reaction between oxygen and the base metal at elevated temperature. The necessary temperature is maintained by the heat from an arc, an oxyfuel gas flame, or other source.

Oxygen gouging – Thermal gouging that uses an oxygen cutting process variation to form a bevel or groove.

Ozone depleting substances (ODS) – These are man-made chemicals which degrade the ozone layer in the upper atmosphere and which are being phased out, both in terms of manufacture and use, in accordance with the Montreal Protocol. Within the marine context, these are the halons, as used in some older fire fighting systems, and the chlorofluorocarbons (CFC) used as refrigerants and in insulation material. Any deliberate emissions of ozone-depleting substances are prohibited.

***Further reading: Regulations for Prevention of Air Pollution,
Annex VI to MARPOL 73/78.***

Ozone depletion potential (ODP) – The ODP of a compound is defined as the ratio of the total amount of ozone destroyed by that compound to the amount of the ozone destroyed by the same mass of CFC-11. The ODP of CFC-11 is defined to be 1.0.

Pad gas – Gas added to the vapour space of the vessel or tank to prevent the forming of an explosive or ignitable vapour-air mixture.

Padding – Charging of the gas pad, usually nitrogen, above the liquid cargo to prevent the cargo coming in contact with air. See also **Environmental control**.

Some substances must be shipped under a suitable protective padding to prevent oxidization.

Paint – A liquid material applied or spread over a solid surface on which it subsequently dries or hardens to form a continuous, adherent, obliterating film. Paint consists of a pigment, a binding agent and a solvent. The pigment determines the properties of the paint. The binding agent determines the consistency and ease of application. The solvent makes the paint flow easily.

Paint cracking – Deep cracks in paint that expose substrate.

Paint system – The complete number and type of coats applied in the painting job. In a broader view, surface preparation, pre-treatments, dry film thickness, and the method of application are included in the specification of a paint system.

See also **Performance Standards for Protective Coatings**.

Pallet – A wooden or steel flat tray for stocking goods in boxes, cartons or bags, can be stacked. Its function is to facilitate the movement the goods, mainly by use of forklift trucks.

Pallet swinger – A crane designed for handling pallets on refrigerated cargo vessels and others where cargo is carried in pallets.

Panama Canal – The Panama Canal is approximately 80 kilometers long and connects the Atlantic and Pacific Oceans. This waterway was cut through one of the narrowest saddles of the isthmus that joins North and South America. The Canal uses a system of locks-compartments with entrance and exit gates. The locks function as water lifts: they raise ships from sea level (the Pacific or the Atlantic) to the level of Gatun Lake (26 meters above sea level). Then, ships sail the channel through the Continental Divide.

Each set of locks bears the name of the town where it was built: Gatun (on the Atlantic side), and Pedro Miguel and Miraflores (on the Pacific side). The lock chambers -steps- are 33.53 meters wide by 304.8 meters long. The maximum dimensions of ships that can transit the Canal are: 32.3 meters in beam; draft -their depth reach- 12 meters in Tropical Fresh Water; and 294.1 meters long (depending on the type of ship).

The water used to raise and lower vessels in each set of locks flows from Gatun Lake by gravity; it comes into the locks through a system of main culverts that extend under the lock chambers from the sidewalls and the center wall.

The narrowest portion of the Canal is Culebra Cut, which extends from the north end of Pedro Miguel Locks to the south edge of Gatun Lake at Gamboa. This segment, approximately 13.7 kilometers long, is carved through the rock and shale of the Continental Divide.

Ships from all parts of the world transit daily through the Panama Canal. About 13 to 14 thousand vessels use the Canal every year. In fact, commercial transportation activities through the Canal represent approximately 5% of the world trade. The Canal has a work force of approximately 9 thousand employees and operates 24 hours a day, 365 days a year.

When the construction of new locks is completed, the canal will handle post-Panamax ships of maximum dimensions being: Length 365.8m, Breadth 48.8m, Draught 15.2m, with TEU capacity of 13,000.

According to www.pancanal.com where all information on Panama Canal can be found.

See also **Arrangement of chocks and bitts for transit of Panama Canal.**

Panama Canal SOPEP – A special SOPEP manual requested by the Panama Canal Authorities. The Panama Canal Authorities have announced that since 2004-01-01 a national regulation is coming into force that each ship going to transit Panama Canal Waters and carrying more than 400 tons of oil has to carry a “Panama Canal SOPEP”. This manual is to be furnished by the owners and to be approved by the authority.

Panel – One unit of a set of hatch cover closures.

Panting – The pulsation in and out of the bow and stern plating when a ship alternately rises and plunges deep into water.

Paper carrier, newsprint carrier – A special cargo vessel designed to transport paper cargo. Paper carriers are often equipped with side loading system. To prevent damage of the sensitive paper cargo, all welds on the deck and double skin are usually ground smooth. All lashing fittings and lights are also flash, both to prevent scuffing as well as the damage due to the contact with the masts or clamps of the trucks.

Parallel mid-body – The ship length for which the midship section is constant in area and shape.

Parallel Side Loader – An innovative gantry-type shipboard **crane** developed by Wijnne & Barends for the handling of forest products and containers.

Parametric roll resonance – A ship in longitudinal seas experiences a completely different shape of the underwater volume as compared with the ship in calm water and in beam seas. The reduction of righting arm GZ at wave crest causes a larger heel under the action of wind and sea. The ship rights again, due to the increased righting arm GZ in the wave trough, when the wave passes the ship. The ship in a seaway behaves dynamically, i.e. she starts rolling, and passes the upright position when returning from the first large roll. If the time of the large roll to the opposite side coincides with a wave crest passing the vessel, then the ship ends up with another reduction of righting arm GZ, and consequently with larger roll. Roll amplification due to the “timing” of the restoring moment variation with the roll motion is called “parametric resonance”.

This resonance can cause the ship to roll to very large angles in a moderate sea, leading to cargo damage, loss of containers and, in extreme cases, capsizing of the ship.

Further reading: *ABS Guide for “Assessment of Parametric Roll Resonance in the Design of Container Carriers” (2004), can be downloaded from www.eagle.org*

Large container ships are prone to parametric rolling because the shape of the fore body and aft body are usually very different, leading to a variation of righting levers as wave crests and trough move alongside the ship. A small initiating force at the right time from the rudder, wind gusts and other influence can set the ship rolling to a large angle. Possible consequences on machinery operation of the ship heeling to very large angles include: loss of cooling water, loss of suction, exposure of lubricating oil sumps and, for resiliently-mounted engines, problems with connection of services – and hence shutdown of the main engine.

Parametric roll prevention system (IPRP) – The anti-heeling system developed by the German company Interling™ to prevent the build-up of **parametric rolling** in head or following seas. Sea-keeping model tests demonstrate that the system can reduce the risk of parametric disturbance by shifting the critical wave threshold to such high values that the chances of ever encountering such a roll during a vessel service life are extremely low.

A typical example of a complete ship system will include several pairs of U-shaped tanks and pneumatically controlled air valves, plus a control unit with pitch and roll sensors. The controller detects the starting phase of parametric rolling and tunes the tank water period and its damping characteristics by operating the valves according to the actual ship motion.

With the **metacentric height** reduction of appr. 10%, the system will prevent from excessive parametric rolling in significant wave heights up to approx. 10m event at zero speed.

Parametric rolling – The stability moment of a ship is the product of the righting lever and the total weight. In head or following seas, the righting lever varies periodically due to the changing wave elevation around the ship and her pitch motion. This, in turn, causes the stability moment to vary, which can trigger rolling. The phenomenon is known as parametric rolling because its source is the time variation of a parameter. This resonance can cause the ship to roll to very large angles in a moderate sea, leading to cargo damage, loss of containers and, in extreme cases, capsizing of the ship.

Ships capsized although they fulfilled the criteria of stability. Analysis of some cases highlighted the parametric resonance as the cause of the disaster. The surprising discovery was that the righting arm could be negative on wave crest.

Paravane – Device used to achieve lateral separation for In-Sea Equipment towed from a **seismic vessel**.

Partially weatertight hatch covers – Hatch covers without sealing between comings and panels and with non-weatertight gaps between panels. Such covers can be fitted on board containerships with high freeboard. Hatches within the forward quarter length shall be located at least 6.9m above the designated freeboard deck, other hatches at least 4.6m.

The gaps between panels should be as small as possible and proportional to the capacity of the bilge system, as well as to the capacity of the fire-extinguishing system, and in any case should be not more than 50 mm.

Further reading: *MSC/Circular.1081- "Guidelines for Partially Weathertight Hatchway Covers on board Containerships"*

Particulates, particle matter (PM) emissions – A complex mixture of inorganic and organic substances comprising mainly soot (elemental carbon), nitrates, carbonates and a variety of non, or partially, combusted hydrocarbon components of the fuel and lubricating oil. The quantity of these emissions depends on the quality of engine maintenance with PM emissions increasing as the level of maintenance decreases. Wet cleaning of the exhaust can remove over 60 percent of particulates, but creates the problem of disposing of the acid water. See also **Exhaust gas emissions**.

Passenger – A person on board a vessel at sea who is neither the master, a member of the crew nor engaged in any way in the business of the ship. A child under one year of age is not considered to be a passenger.

Passenger/cargo ship FINNMARKEN

The FINNMARKEN is a cruise ship that can carry vehicles and both dry and refrigerated cargoes. Built by Kleven Verft, it is operated by the Norwegian company OVDS, linking towns on the Norwegian coasts from Bergen in the south west, to Kirkenes near the Russian border. The vessel can accommodate up to 1000 passengers and there is accommodation for 643. Passengers enter through a door on the port side. There are 12 suites, two of which are grand suites with private balconies. A high proportion of the cabins and mini-suites are located outside.

The Finnmarken has eight decks. Deck four houses the ship restaurant and features large windows extending around the curved stern and down each side. The deck also incorporates public spaces including a bistro, bars and shops. There is a conference area of four rooms, which can accommodate approximately 200 seats. The fifth and sixth decks contain the cabins and suites. Deck seven contains a lounge and a cafe and a swimming pool. Deck eight houses the panorama lounge which extends forward over the **bridge**. It also contains a fitness centre, which is partly cantilevered out over the swimming pool.

The FINNMARKEN has three cargo holds of 75m³, 407m³ and 308m³ in volume, all insulated to a K-value of 0.465W/m/sq/C and able to take chilled or frozen cargo with individual temperature regulation. The ship has eight provision rooms, six for chilled stores and two for frozen, plus a thawing room. The total provision room volume is about 306m³. There is an additional cold room by the galley on deck four.

The vessel is driven by two shaftlines. Each of them has a Wärtsilä W9 L32 nine-cylinder main engine, which has an output of 4,140kW. It is located ahead of the Wärtsilä Lips TCH 150V 85-550 reduction gearbox.

Each shaftline also has a six-cylinder engine mounted aft off the gearboxes which can be coupled either to their own generators or to the main gears. The sets of engines are separated by a stepped bulkhead.

The two controllable pitch propellers are supplied by Wärtsilä-Lips. Steering is by a twin Wärtsilä **Efficiency Rudder**. For comfort, there are two anti-roll stabilisers located amidships. At the bow, there are also two tunnel **thrusters** as well as an azimuthing thruster at the stern. Concycle shaft generators produce constant voltage and frequency when operating at variable speeds. One **shaft generator** can also function as a motor when fed with power from the other.

The control centre includes an Atlas NACOS navigation and command system with 1019 ARPA Sand 1019 ARPA X radar and a multifunction display. This permits a radar image to be super-imposed on the ECDIS electronic chart display.

The ship uses Atlas planning stations consisting of an A1-size digitising chart table with a planning and consulting station. Navigation also includes a C Plath speedlog type Naviknot III.NF and an Atlas Doppler log. There are also two Plath Navigat X Mk1 gyrocompasses, two Trimble NavtracXL DGPS receivers with remote units and a Furuno Loran C.

A Sailor GMDSS radio, Inmarsat C with EGC receiver and a Saturn B class 1 satcoms system form the major elements of the communications system.

Classification DNY + 1 A 1, Car Ferry, ICE 1 C, EO, NAUT-C, RM (-28/+30(sea), clean Design, F-C. The Finnmarken has an overall length of 138.5m, or 116.6m between perpendiculars and a mid breadth of 21.5m. It has a 4.95m maximum draught and a height of 29.6m. There are 14 watertight subdivisions below the bulkhead deck.

Passenger spaces – Spaces provided for the accommodation and usage of passengers, excluding baggage, store, provision and mailrooms, (SOLAS).

PaxCar ferry MARTIN i SOLER

Photos courtesy of Astillero Hijos de J Barreras



The ferry features a hull topped with a virtually full length superstructure containing four decks laid out with public rooms and cabins for 1164 passengers and 36 crew. Drivers are catered for separately with 4x4 berth cabins. Forward and aft facing lounges with panoramic views, video games rooms and a children’s playground are amongst the leisure attractions available to travelers, and open deck space is also provided for recreation. Two double rooms are equipped for disabled passengers, and a lifesaving equipment package to the highest specification includes two RFD marine evacuation systems using vertical chutes, each serving 430 persons, also two 150 person and two 30 person lifeboats, all supplied by Certasa. Rescue boats are also fitted.



PAXCAR FERRY MARTIN I SOLER

Photos courtesy of Astillero Hijos de J Barreras

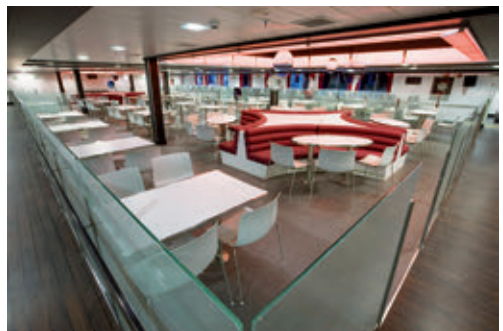
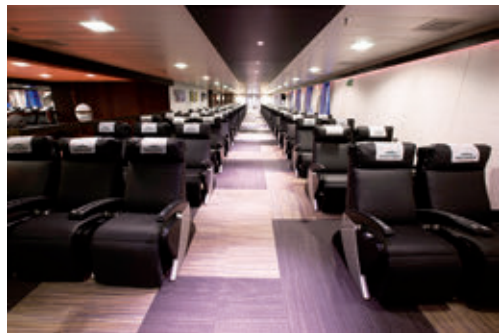

Main access is to deck number 3 over two stern ramp/doors, each 14.50m long x 9.50m wide, designed for the simultaneous passage of two 16m long vehicles. A four metre wide bow/ramp door serves the same deck, and a tilting ramp links the main deck with double bottom.

Three fixed, and one hoistable, car decks are provided, and these can accommodate vehicles in various combinations, such as 107 cars and 96 trailers (2.90m wide and 16m long) with car deck hoisted, and 334 cars and 65 trailers with this deck unhoisted.

The vessel is powered by a pair of main engines, each developing 9000kW MCR at 500 rev/min and driving twin CP propellers through Reintjens gearboxes for service speed of 21.4 knots. Electric current is derived from two 1300kW Leroy Somer shaft-driven alternators, and three MaK/Leroy Somer diesel sets of 1080kW output each. Two 1000kW thrusters operate at the bow, and a pair of fin stabilizers and an anti-heeling system enhance passenger comfort and assist with stability whilst cargo handling.

Length, oa: 165.30m, Length, bp: 152.50m, Breadth, mld: 25.60m, Depth, mld to main deck: 8.50m, Draught design/maximum: 5.50/6.00m, Deadweight maximum: 4370dwt, Gross tonnage: 24,761, Propulsion power: 2x9000kW, Service speed at 90% MCR: 21.40 knots.

Payload – Freight-carrying capacity of a ship.

Pedestal roller fairlead, pedestal roller guide – A roller fairlead usually operating in a horizontal plane. Its function is to change the direction of lead of a mooring or of other line on a deck. See also **Mooring fittings**.

Pelagic freezer trawler AFRIKA

According to **HSB International** April 1999

The pelagic freezer stern trawler AFRIKA is designed to operate in the tropics, fishing mainly for sardinella and horse mackerel. Built by YVC Ysselweft the 6400dwt vessel has an overall length of 126.20m and a beam of 17.50m. It has a long foredeck with the superstructure close to the stern, leaving a trawl deck aft of the **wheelhouse**.

Fishing gear is handled over the stern using the giant trawl winch supplied by Brusselle Marine Industries driven by two Bakker Sliedrecht 350kW electromotors. The eight-drum trawl winch has two shaft lines. The lower shaft carries two main drums, each for 4000m of 40mm diameter steel wire rope, two auxiliary drums, each for 83m of 32mm diameter steel wire rope and one net drum having a net capacity of 20m³. The two main drums are provided with an automatic wire-rope reeling system of the cross-spindle type. The nominal total pull on main drum 11th layer is 510kN at 0-72m/min with a brake force of 660kN.

The upper shaft carries two auxiliary drums, each for 83m of 32mm diameter steel wire rope, and one net drum having a net capacity of 20m³.

The eight drums, arranged on two sectional shaft lines, are carried by roller bearings with central gearcase. An automatic lubrication device is provided for reaching all the moving parts.

Deck operations are controlled from a console at the back of the wheelhouse with a full view over the deck. All of the winches are operated from this position.

The AFRIKA has no stern ramp. Once the fish is caught and the net is hauled in, the catch is transferred into Refrigerated Sea Water (RSW) tanks with a large submersible fish pump handled by a hydraulic crane. The fish pump has a capacity of 250 tons per hour (1400 m³ fish/water per hour) and transfers the fish from the net to the fish bins from where it is immediately discharged through hatches into twelve RSW tanks where the fish is pre-cooled.

Pelagic species

Subsequently, the fish is vacuum-pumped with a fish pumping system to the sorting belt and to six cooled sorting bins, from where it is pumped to a conveyor system leading to 40 vertical plate freezers. After having been frozen to a temperature of minus 25°C, the fish blocks, weighing about 25 kg each, are sealed in sealing machines and then packed into cardboard boxes and stowed in refrigerated holds.

The handling equipment to transport the fish from the packing station to the fish holds consists of horizontal and vertical conveyor systems. The holds of the vessel are fully equipped for palletized cargo to be discharged by forklift trucks to the hatches and from there landed with shore cranes.

Length o.a.: 126.22m, Length b.p.: 118.99m, Breadth, mld: 17.50m, Depth, mld: 11.02m, Draught: 6.85m, Deadweight: 5977dwt, Speed: 17.6knots, MCR: 7210kW.

Pelagic species – Fish living above the bottom levels, predominantly such as herring and mackerel. See also **Demersal species**.

Pentamaran – The patented hull form developed by Nigel Gee and Associates Ltd. The pentamaran is a slender stabilised monohull which offers the potential for a 30% power reduction in large high-speed vessels, compared to existing monohulls or catamaran.

Perbunan – A seawater- and oil-resistant rubber compound used for sterntube lip seals.

Performance Standards for Protective Coatings (PSPC) – The new industry guidance contained in the **IMO** Resolution MSC.215(82) provides requirements for protective coatings in dedicated seawater ballast tanks in all types of ships and double-side spaces of bulk carriers.

The PSPC is not significantly different from coating specifications used in the past. The most significant impact of this requirement is that it provides a common minimum standard for all owners and shipyards. The requirements extend through the whole process from specification to application, detailing the role of each party involved, the approval of coatings to be applied, and the process of inspection. Under the new standard, the coatings are to be light colour epoxy-based using a multi-coat system. The standard is intended to provide a target useful coating life of 15 years, over which the coating system is intended to remain in good condition.

Further reading: *ABS Guide for the Class Notation “Coating Performance Standard” (2007)* – can be downloaded from www.eagle.org

Period of roll – The time necessary for one complete double oscillation or **roll** of a ship as from port to starboard and back to port.

Periodical hull surveys – Annual, intermediate and special surveys. The purpose of the annual and intermediate **surveys** is to confirm that the general condition of the vessel is maintained at a satisfactory level. The special surveys of the hull structure are carried out at five year intervals with the purpose of establishing the condition of the structure to confirm that the structural integrity is satisfactory and will remain fit for its intended purpose until the next special survey subject to proper maintenance and operation.

Permanent magnet motor – The electrical motor of the novel type. It promises high powers at relatively low weights. However, it always requires a **converter**. The motor is practically maintenance-free, but to make repairs a specialized workshop is required.

Permanent set or **deflection** of seal – After the seal has been in service for some time, the rubber loses some of its elasticity and has a permanent groove visible on the sealing face, measured in mm.

Permeability of the space – There are many different spaces and compartments on board a ship. Some of them could be quite empty, others can house some equipment, and therefore its different parts can be occupied by water in case of flooding. Permeability of the space means the ratio of the volume within the space which is assumed to be occupied by the water to the total volume of that space.

Personnel capsule – A manned, non-self-propelled submersible tethered unit consisting of one or more chambers. All of them are maintained at an internal pressure near one atmosphere.

Personnel evacuation system – The method of evacuation from an oil rig in very severe weather conditions. The system consists of a cable car running between a specially equipped support vessel and the oil rig. Assistance is required from the oil platform to connect up the evacuation system.

Petroleum – **Crude oil** and liquid **hydrocarbon** derived from it.

Petroleum gas – A gas evolved from petroleum. The main components of petroleum gases are hydrocarbons, but they may also contain other substances, such as hydrogen sulphide or lead alkyls as minor constituents.

Petroleum products – Petroleum oils are characterised as either black or white (clean). Black oils include **crude oil**, furnace oil, fuel oil, tar and asphalt. White oils include benzene, kerosene, and gasoline.

Physically drying paints – Paints that dry solely by evaporation of solvent. The binder is unreactive.

PICKUPCAT concept – The PICKUPCAT concept is based on dividing a vessel into two separate parts: a self-contained catamaran containing power, propulsion and steering functions and an interchangeable cargo-carrying unit. The cargo unit may serve as a floating storage facility, independently of the propulsion unit which is free to operate elsewhere. While at sea, the pusher unit and the cargo section operate as one ship.

Pier – The structure perpendicular to the shoreline to which a vessel is secured for the purpose of cargo loading and unloading.

Piggy-back cover – Hatch cover arrangement where a wheeled panel carries another panel on its top during travel on the coaming. See also **Hatch cover**.

Pigments (painting) – Powders, insoluble in resins, which give the paints their colour, finish, and protective properties.

Pile – A hollow steel pipe installed into the sea bed by means of a piling hammer or vibrator and used as anchoring point. Generally, the pile has to be installed at great depth below seabed to obtain the required holding capacity.

Pillar – Vertical member or column giving support to a deck girder, flat or similar structure: also called stanchion.

Pilot – A person who is qualified to assist the master in navigation while entering or leaving a port.

Pilot boat, pilot launch, pilot tender, pilot cutter – Usually small, fast and highly manoeuvrable craft used to deliver pilots from a harbour to vessels.

Pilot ladder – A rope ladder provided for a pilot to embark and disembark safely. The pilot ladders shall be located in a place clear from any possible ship discharges. According to **SOLAS** the length shall be sufficient to reach water surface when the vessel in **ballast** condition has an adverse list of 15°. Unfortunately such ladder is too long with steps on

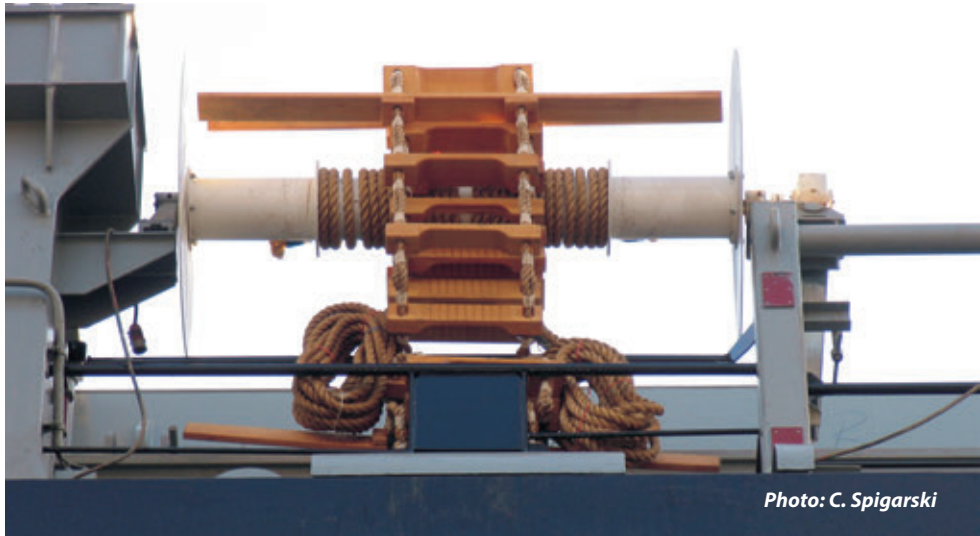

Note: Pilot ladders on stowage drum tend to stay clean, are easy to rig, retrieve and survey, and they last longer too. However, the drum should NOT be used to hoist/lower a pilot from/to the pilot boat.

the deck of the **pilot boat** presenting a hazard to both the pilot and deckhand. In practice it would be better to have two additional ladders with length adjusted to prevailing draught conditions.

In case of high freeboard (more than 9m), the pilot ladder shall be combined with an **accommodation ladder**. See also **Boarding arrangements**.

Further reading: *Shipping industry guidance on The rigging of ladders for pilot transfer* www.empa-pilots.org

Pilot mechanical hoist – A pilot boarding hoist raised by a power winch. The mechanical pilot hoist should be designed to operate as a moving ladder, or as a platform, to lift and lower one person on the side of the ship.

Further reading: *Recommendation on Pilot Hoist* www.empa-pilots.org

Pilot shelter platforms – Covered stands required by Regulations on Navigation in Panama Canal Waters onboard vessels with a breadth of 30.48m, and overall length of 274.4m or more.

Pilotage – The activity carried out by a **pilot** assisting the master of a ship in navigation while entering or leaving a port.

Pinholes – Tiny holes through the entire paint film down to the substrate formed during application and drying.

Pinpoint rusting – Local rusting at **pinholes** or holidays.

Pintles – The pins or bolts that hinge the rudder to the gudgeons on the sternpost or rudderpost.

Pipe fittings – Components such as sleeves, elbows, tees, bends, flanges, etc., which are used to join pipe sections.

Pipe joints – Butt-welded joints, socket-welded joints, slip-on welded sleeve joints, flanged joints, threaded joints, expansion joints.

PILOT LADDER

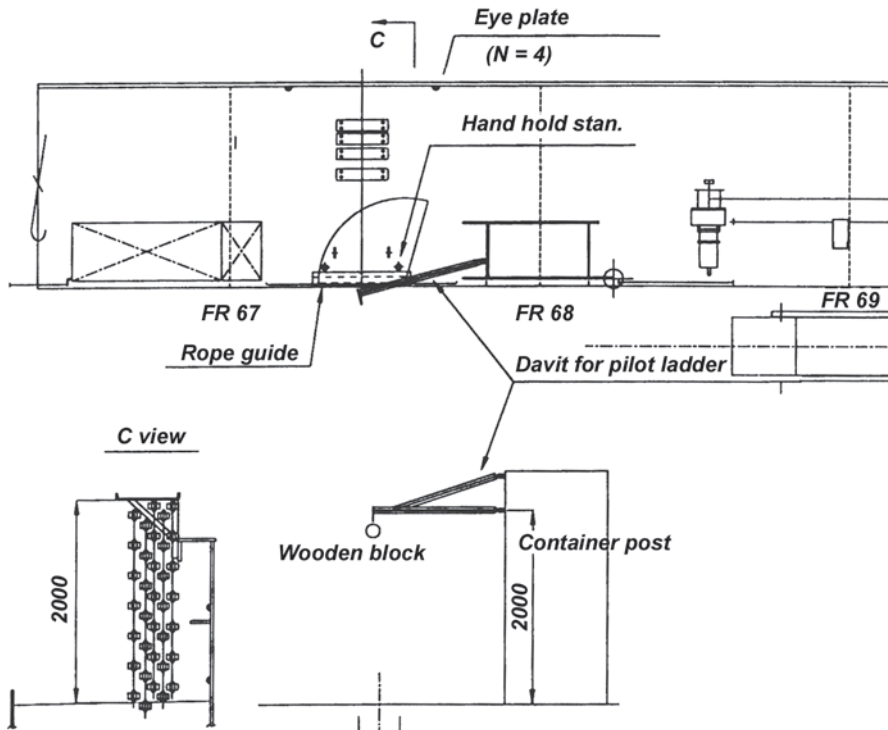

Pilot ladder



Photos: J. Babicz

Pipe schedules

Pipe schedules – Pipe schedules are designations of pipe wall thicknesses as given in American National Standard Institute, ANSI B36.10.



Pipe tunnel – The void space running in the midships fore and aft lines between the inner bottom and shell plating forming a space for ballast, bilge and/or fuel lines.

Pipelay/Heavy Lift vessel SEVEN BOREALIS

SEVEN BOREALIS is 182.2m long, with a breadth of 46.2m, and an operating draft of 8.5-11.35m. The vessel's CLEAN-DESIGN notation, conferred by DNV, covers requirements including ballast water and fuel oil handling as well as low NOx and SOx exhaust emissions. The classification also recognizes environmental measures in place such as double-hull protection for the fuel oil tanks, bilge, and ballast water management.

The 5000t Offshore Mast Crane, said to be the world's largest, was manufactured at Huisman's Zhangzhou facility in China, and installed on the vessel during a four-day operation in March 2011. The mast is just over 85m above the main deck, and with the 120m boom extended to its highest elevation, the boom tip will be more than 151m above main deck. The crane has two main blocks of 2500t and can lift 5000t at 34m radius. With a footprint of only 16.8x16.8m and total weight of 4100t, it offers a very effective net outreach. In addition there is a heave compensated hookblock, which depending on its reeving offers lifting capacities of 1200t (4 falls: 1500m waterdepth), 600t (2 falls: 3000m waterdepth) and in single fall mode 300t that can go down to 6000m!! There is also a 110t whipoist. Additionally, there are four load tuggers and five block tugger winches.

Huisman's crane is designed for a variety of lifting tasks. Both main blocks allow for a 40° side lead with a combined spread angle of 80°, rendering unnecessary the slings and spreader beams normally needed for dual lifts. An auxiliary hoist, combined with the dual-lift functional, allows for three-point lifts and upending operations without concerns over the position of the load's center of gravity, as this can be controlled by adjusting the tackle length.

The auxiliary hoist also serves as the vessel's heave-compensated deepwater lifting mechanism, with the heave compensator positioned below main deck. This cancels the effect of wave-induced roll motion and heave on the ship that could generate vertical motions of the crane's load.



Stability during installation operations is another feature. To compensate for heeling motions caused by offset crane loads, five pairs of ballast seawater tanks and 15 pumps are available, each capable of transferring water at up to 1300 m³/h. Total ballast water capacity is 41,021 m³. Filling and emptying of the tanks is controlled by a Kongsberg vessel management system. Four flume tanks generate additional roll damping to lessen roll motion induced by heavy sea states by around 40%.

The vessel is equipped with an S-lay system to lay pipe from 4.5" to 46". For laying pipe in extreme deep water, the J-Lay tower, positioned at SB side of the vessel can be used and can lay pipe from 4" to 24" in water depths upto 3000m.

The J-lay system has a 750t static and 937t dynamic tension capacity, and is mainly for use in deeper water projects (up to 3000m). Its tower is supported by a gimbal suspension which, in active mode, compensates for the vessel's motion up to a maximum tower tilt angle of 12±3° over an azimuthing range of 180°. This minimizes the forces on the pipe and lessens bending.

Friction clamps can accommodate coated steel pipe double joints pre-assembled onshore in diameters of 4-24-in. (10-61cm), typically 19-26m long, and weighing up to 30t each. Additionally, the J-lay system can be deployed for constructing risers and installing pipeline end termination structures of up to 100t and tees.

The S-lay system is designed for pipelay in water depths ranging from 25-3000m, and is suited to single and double joints in the range 4.5-46-in (11-117cm) diameter. It can lay 200km in one go operating at full speed. The S-lay equipment spread includes three 200t tensioners and a 200t and 600t A&R winch system. The latter also can be deployed to the vessel's starboard side to lift manifolds up and onto the seafloor.

The firing line incorporates work stations for different processes, including welding, non-destructive testing, and field joint coating. It can be adapted for 11 single-joint stations or six double-joint stations, depending on the type of pipes to be handled. The three-section

PIPELAYING METHODS

stinger is 92.5m long – depending on the project requirements, only one or two sections may be needed – with a stinger radii configuration varying from 70-300m. The S-lay system allows a very steep (close to 90°) departure angle during deepwater pipelay.

Also on board are two work class, 3000m water depth-rated Schilling ROVS that can be deployed using 1500m tethers, facilitating touch-down monitoring of the pipeline during laying.

Onboard power is provided by six 5.76MW diesel generating sets, backed by a 1.6MW MTU emergency generator. The switchboard and engine rooms are configured to ensure station-keeping thruster capacity at all times for the DP Class 3 redundant dynamic positioning system. This is served by four 3.2MW retractable FP azimuthing thrusters, three at the bow and one at the stern, supported by an 2.5MW tunnel thruster. They can deliver thrust in a full 360° arc as required by the DP system. Main propulsion is by two FP 5.5MW azimuthing thrusters at the stern. The vessel's service speed is 12 knots.

PIPELAYING METHODS



Photo courtesy of Wärtsilä Corporation

Dynamically positioned pipelaying ship AUDACIA with the stinger on the bow. The stinger is made out of several hinged sections to make it articulated. Hence, the stinger shape and curvature can be controlled by setting these segments at chosen angles

S-lay method

Conventional method for rigid pipe. When using the S-lay installation method, onboard welded **pipe joints** leave the vessel horizontally and are guided to the seabed over a “stinger” - a structure on the back of the ship that supports the seagoing pipe string to control its bend radius. The pipe is lowered using tensioners. Due to its high production rate and the possibility to install concrete coated pipe, S-lay is extremely suitable for pipe installation in shallow and intermediate waters. Larger water depths are equally possible but require a very long stinger, turning S-lay into a less practical and efficient solution.

J-lay method

One method for installing subsea pipelines in deepwater is by J-lay installation. Pipe stalks with a length up to 6 joints are upended and welded to the seagoing pipe in a near vertical ramp. The ramp angle is chosen in such a way that it is in line with the pipe catenary to the seabed. The J-lay method is very suitable for deepwater as the pipe leaves the lay system in

Photo courtesy of Huisman-Itrec



Semi-submersible crane and pipe lay vessel SAIPEM 7000 with J-lay tower

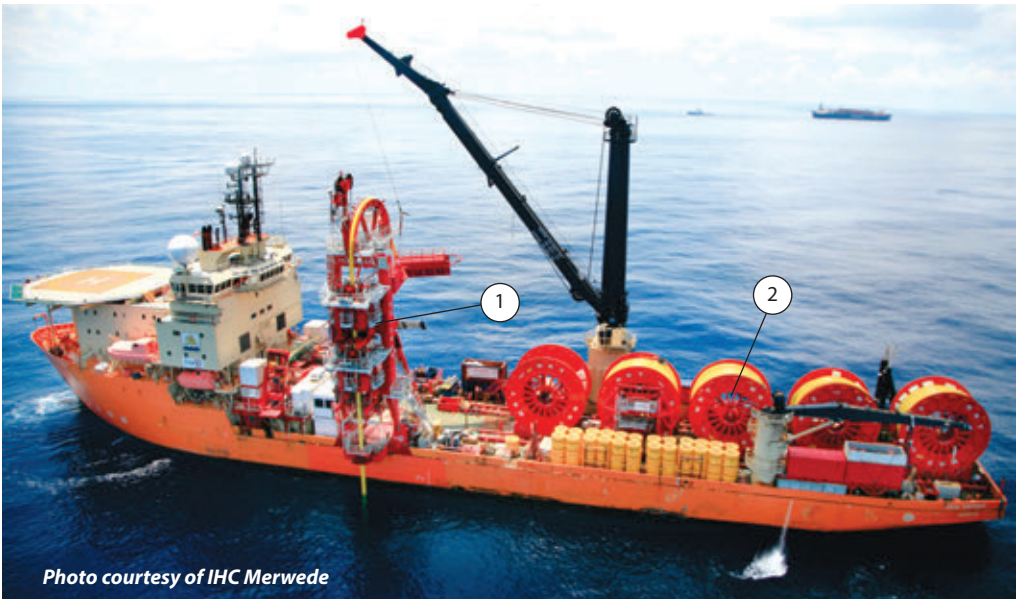

Photo courtesy of IHC Merwede

*Multi-purpose offshore vessel TOISA PERSEUS
1. Vertical lay tower 2. Storage reel*

PIPELAYING METHODS

an almost vertical position. The pipeline is only bent once during installation (at the seabed) which is advantageous for installing pipelines that are sensitive to fatigue. Compared to other lay methods, J-lay has a relatively low production rate due to the single welding station. The J-lay method is less suitable for shallow waters as this requires a steep departure angle.

Reel-lay method

Reel-lay and carousel-lay are used for rigid and flexible pipes: large lengths of pipe are welded, tested and coated onshore and then spooled on vertical reels or horizontal carousels on board the lay vessel. During pipelay the pipe is unspooled from the reel or carousel. Straightening of the pipe is required before it is over boarded. The advantages gained by the high production rate as well as the controlled welding and inspection conditions onshore, make Reel-lay an extremely efficient method for the installation of pipelines up to 20 inch in all waters.

See also **Flexible pipelaying ship SEVEN SEAS**

Combination of Reel-lay and J-lay

Using the reel lay method, pipe is welded onshore into long lengths, which are coated and loaded onto a large storage reel on the vessel. The pipe is plastically deformed around the hub of the reel.

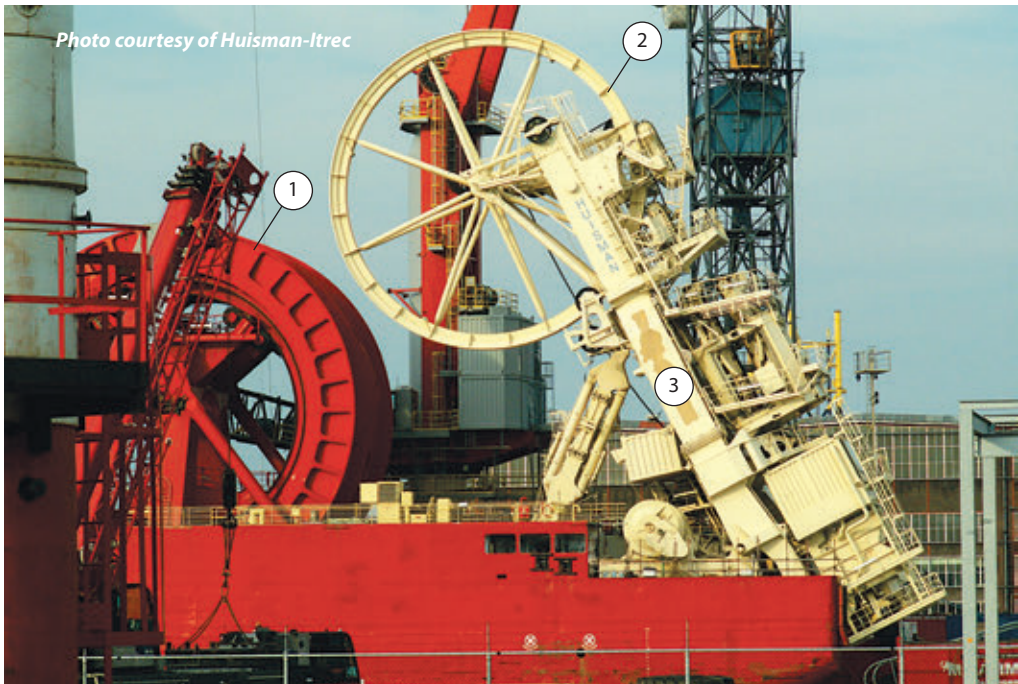

1. Main storage reel 2. Aligner wheel 3. Tilttable lay ramp

When the pipe is laid offshore, it is pulled off the reel over an aligner at the top of the lay ramp, passed through a straightening system, and the process of lowering the pipe to the seabed is controlled by linear tensioners which grip hold of the pipe as it passes. The main benefit of this approach is that much of the welding and coating is undertaken onshore.

See also **Rigid pipelaying ship SEVEN OCEANS**

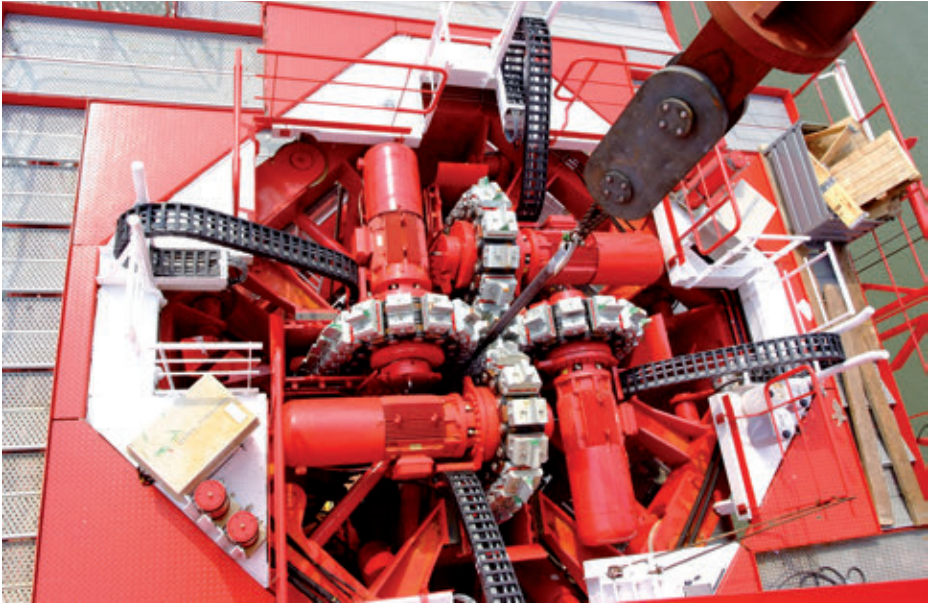

Pipe tensioner



Pipe straightener

Pipelaying system of the MIDNIGHT EXPRESS

Typical components for pipelaying systems are:

- Pipe tensioners
- Abandon & Recovery winches
- Hang of clamps
- Pipe straighteners
- Line up systems,
- Pipe storage reels
- Carousels
- Pipehandling equipment
- Pipe transfer cranes
- Stinger handling systems.

For further information visit www.huisman-itrec.com

Pipelaying system of the MIDNIGHT EXPRESS

Deepwater installation vessel MIDNIGHT EXPRESS was converted from a former LASH barge by the Canadian shipyard Davie Maritime in Quebec. The vessel has a new, patented reel-laying system, designed, manufactured and installed by Huisman-Itrec. After its conversion, the vessel is able to lay small- to mid-diameter rigid and flexible pipes in varying water depths, up to a maximum of 3000m. The J-lay system is configured to accommodate rigid pipes from 2.5-in. to 12.75-in. outside diameter, at tower angles ranging from 63° to 90°. The system is capable of pipe fabrication and spooling operations. It comprises the tower, an aligner wheel, one tensioner, a hang-off clamp, one adjuster, one abandonment and recovery (A&R) winch, two pipe storage reels, and associated workstation on the vessel deck.

The 12.3m long pipe segments are welded, inspected, and coated in the deck workstation. The pipe is spooled onto the reel via the deck tensioner. During unwinding of the first reel via the tower, the second reel is spooled with a new pipe. The total storage capacity per reel is 600t, with a spooling tension 200kn. The laying speed at maximum tension is 20 m/min.

During pipelay, the complete tower is automatically skidded sideway to keep it in line with the unwind position of the pipe on the corresponding reel. The shaft of the large aligner wheel can be adjusted lengthwise to ensure that the center of different pipe diameters remains at the same firing line.

The main 160t tensioner is equipped with four tracks. Depending on pipe diameter and wall thickness, two or four tracks are in operation. For the A&R function to handle the pipe's loose end when laying is interrupted, a 250t traction winch is deployed in combination with a large storage winch suitable for 3,000m of wire. The traction winch is installed directly on the tower while the storage winch is kept below deck. During skidding of the tower, the storage winch is maintained in automatic active mode to compensate for length variation of the wire.

For further information visit www.huisman-itrec.com

Pipeline – A primarily horizontal pipe lying on, near or beneath the seabed normally used for the transportation of hydrocarbon products, (ABS).

The 826km long NorFra pipeline runs from the platform complex in Norwegian waters to Dunkerque in France. The 42in-diameter pipe has a wall thickness of up to 30.3mm and its concrete weight coating ranges from 65-110mm thick. When carrying that thickest concrete coat, a single 12m joint of pipe weighs 25t.

Pipeline bundles – Arrangement of two or more pipelines laid parallel and directly contiguous.

The two 7.5km bundles will link the subsea manifold to the field main production platform. Weighing 12,000t in air, the bundles contain a 14in production line, an 8in test line, a 3in methanol line and finally, a 12in pipe to circulate hot water. It will be pumped from the platform to the subset manifold at 90°C and return via the annulus for recycling, helping to prevent the formation of waxes and hydrates within the flowlines.

Pipeline End Terminations (PLET) – A significant part of pipelaying vessel time is used for special operations like PLET handling or diameter changes. These operations normally require crane assistance which is time consuming and involves more safety risks. The PLET handling system allows for easy transportation of the PLET from the storage position to the ramp. It enables the execution of PLET operations without crane assistance in an efficient and safe way.

Pipeline system – An integrated set of sub-sea flowlines and pipelines including pertinent instrumentation, foundation, coatings, anchors, etc, (ABS).

Pipes – Pipes are pressure-tight cylinders used to contain and convey fluids.

Piping components – Pipes, **tubes**, valves, fittings, flanges, gaskets, bolting, hoses, expansion joints, sight flow glasses, filters, strainers, instruments connected to pipes, etc.

Piping system – A network of piping designed and assembled to serve a specific purpose. Piping systems interface, but exclude, major equipment, such as **boilers**, pressure vessels, tanks, **engines**, **turbine** etc. They are divided into three classes according to service, design pressure and temperature. Each class has specific requirements for joint design, fabrication and testing.

The various piping systems perform such functions as cooling, heating, cleaning and lubricating of the various machinery items.

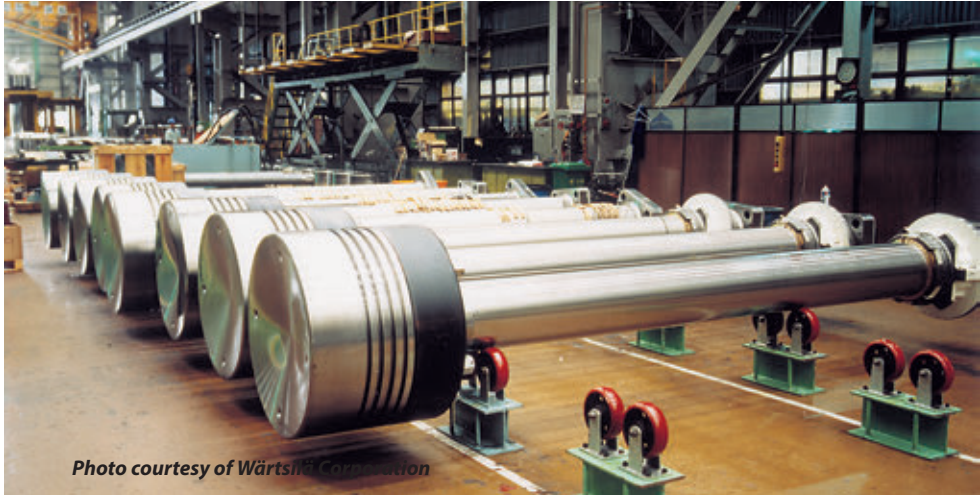

Photo courtesy of Wärtsilä Corporation

Piston – A cylindrical metal item which reciprocates within a cylinder. It may move as a result of fluid pressure as in an engine, or it can compress a fluid, as in a pump or compressor. The piston consists of **piston crown** and **piston skirt** screwed together.

Piston crown, piston head – The upper part of a **piston** exposed to hot gases in an **engine**.

Piston ring – A rectangular cross-section ring of cast iron which is cut to enable fitting over a piston. The ring fits into a groove and creates a gas tight fit of the piston when moving up and down in the cylinder.

Piston skirt – A thin cylinder of material fitted at the bottom end of a piston. It serves to close the ports in a two-stroke engine.

Pitquard anode – A sacrificial **anode** placed just above the tank bottom in order to mitigate the general and pitting **corrosion** process.

Planking – Wood covering for decks, etc.

Planning craft – The vessel with the hull suitably shaped to develop the hydrodynamic forces during forward motion, sufficient to support the craft with a substantial proportion of the hull out of the water. The wetted area is thus smaller than at a low speed, and so for a given speed the viscous resistance is also reduced. A semi-planning vessel is a craft that is supported partially by the buoyancy of water it displaces and partially by the dynamic pressure generated by the bottom surface running over the water.

Planning terminal – The **bridge** workstation, remote from the operational area of the bridge, which allows for the planning of routes and preparation of user-defined charts and radar maps.

Plasma-arc cutting – A process used primarily for the cutting out of steel components from plate in the workshop. It is both quicker and more accurate than oxy-acetylene cutting and may be used on materials such as aluminium alloys. The finished article can normally be welded without further edge preparation.

Plasma-air cutting employs an extremely high temperature, high-velocity constricted arc between an electrode within a torch and the metal to be cut. The intense heat melts the metal, which is continuously removed by a jet-like stream of gas coming from the torch.

Plastic – A solid material which contains one or more synthetic organic high polymers as essential ingredients.

Plasticity – The property of a material that allows it to be extensively and repeatedly deformed without rupture and that allows it to retain its deformed shape after the applied force has been removed.

Platform supply vessel VIKING ENERGY

The VIKING ENERGY is the world first LNG-fuelled PSV. The construction of the hull and superstructure was subcontracted to the Polish shipyard Maritim in Gdańsk from where it was towed to Kleven Verft in Ulsteinvik, Norway, for outfitting. The vessel was designed by Vik-Sandvik to meet industry demands for minimising greenhouse gas emissions. The VIKING ENERGY has an overall length of 94.9m and a length between perpendiculars of 81.6m. It has a moulded breadth of 20.4m. The depth to the second deck is 6.6m and the depth to the first deck is 9.6m. The ship has a maximum draft of 7.9m and cargo deck area of 1030m². It has complement of 24 crew, accommodated in 12 single berths and six double cabins.

The vessel will take supply materials to Statoil North Sea platforms. It can carry 1300m³ of fuel oil, 2000m³ of water ballast or drill water, 1100m³ of potable water, 200m³ of methanol, 800m³ of brine, 900m³ of liquid mud and 450m³ of dry bulk. The vessel has a gross tonnage of 5073t and a net tonnage of 1521t. Its deadweight is 2886t at 5.9m draught.

The VIKING ENERGY features dual fuel engines, so is able to run on both LNG and marine diesel oil in any proportion. Using LNG results in a 90% reduction of the outlet of NO_x (approx. 200t a year) as well as a 30% reduction in CO₂. This is important in Norway which has undertaken to reduce, by 2010, national NO_x emissions by about a third from the 1999 level. Tests have shown that the vessel has a fuel economy rate of 30% better than that of diesel.

Photo courtesy of Wärtsilä Corporation



The first gas-fuelled PSV VIKING ENERGY

In ten years of operation not a single hour of technical offhire has been caused by the gas system

LNG is stored in a giant “thermos flask” in the middle of the vessel and is well protected. The tank is a horizontal cylinder with domed ends, fabricated from 304 grade stainless steel. It comprises an inner and an outer chamber, with a gap of 300mm between the two maintained under a high vacuum to insulate the LNG at -162°C from the surroundings. The volume is 234m^3 , giving an effective fuel capacity of 220m^3 when filled to the allowable limit. The tank in turn is fitted in a compartment with A60 fire insulation. All gas lines and valves are enclosed in ventilated sheaths, with alarm leakage sensors.

Before it is used, the liquid gas has to be vaporized and supplied to the engines at about 20°C and 5 bar pressure. This is carried out by means of a hot water vaporizer unit. Two coils are fed with hot water from the ship system; one rated at 390kW vaporizes the fuel gas to supply up to $600\text{m}^3/\text{h}$ of free gas, the other smaller unit boils enough LNG to maintain pressure in the tank.

The electric power for propulsion and other services is derived from four main gensets. The main engines are Wärtsilä 6L32 DF 2,010kW engines units, although there is also a Caterpillar 3304T 116kW emergency genset.

These gensets are linked to a pair of contra-rotating 3000kW stern **thrusters** and two 1000kW tunnel thrusters in the bow. The vessel also has 880kW azimuthing retractable thruster for manoeuvring. This arrangement gives the VIKING ENERGY a top speed of 16 knots when fully loaded.

The electric propulsion systems were supplied by ABB in a workscope including a complete package of variable speed drives and power distribution as well as the electric propulsion and

Plating

the thrusters. The vessel uses Direct Torque Controlled (DTC) frequency converters that afford accurate control of thruster magnitude and azimuth, leading to better manoeuvrability of the vessel. This type of motor drive directly reduces vibration and noise, benefiting comfort and the working environment.

Length, oa: 94.90m, Length, bp: 81.60m, Beam, mld: 20.40m, Depth, mld to the first deck: 9.60m, Draught, summer: 7.9m, Deadweight: 6013dwt, Accommodation: 24 beds, Deck space: 1030m², Generator output: 4x2100kW, Main propulsors: two contra-rotating 3000kW thrusters.

Plating – The plates of a hull, a deck, a **bulkhead**, etc.

Plough – A cable plough is a sophisticated seabed tool that creates and back fills trenchers in order to protect all types of submarine cable. See also **Cable operations**.

Plug – A thing used for connecting a piece of electrical equipment to the main supply of electricity.

Pneumatic control valve – A valve which regulates the flow of a fluid. It is remotely-operated as the correcting unit of an automatic control system. The actuator is operated by compressed air.

Pneumatic conveyor system – The loading/offloading system for dry powder material (cement) developed by Merevido Europe B.B. The main elements of the system are a suction/delivery system with filter tank, four aeration floors fitted with fluidisation mat, operating and control panels, and the linework. The air required for aeration purposes is supplied by blower sets. The cement is fluidized by the upward flow of air through the fluidisation mat and then drawn into a suction/delivery tank, which is at subatmospheric pressure. Next, it is forced out again to the shore receiving facility by means of the air pressure generated by the compressor sets.

Pod – An electric rudderpropeller, see **Electric podded propulsors**.

Polar orbiting satellite service – A service based on polar orbiting satellites which receive and relay distress, alerts from satellite **EPIRBs** and which provides their position (**SOLAS**, Chapter IV).

Pollutant – A substance that makes air, waters, soil etc dangerously dirty.

Pollution – The process of making air, water, soil etc dangerously dirty and not suitable for people or animals.

Pollution and accident control ship NEUWERK

According to **MARINE ENGINEERS REVIEW** November 1998

The highly-sophisticated 3830t displacement multi-purpose ship built in 1998 by Stralsund shipyard, Volkswerft GmbH. She is able to meet all eventualities – marine pollution control, fire-fighting and emergency towing operations, buoy tender work, icebreaking and shipping police support tasks.

Pollutant recovery

NEUWERK has two independent systems for the recovery of floating pollutants, their filtration and separation from the seawater, as well as the storage of the pollutants for discharge ashore. Contaminated surface water is collected by a 15m skimmer, port and starboard, and directed to an integrated suction pipe on each skimmer arm and thence to the associated gravity separation units. After separation the water is returned to the sea and the recovered spill is stored in five stainless tanks. One of these tanks of 80 m³ is heatable.

Underwater search

For the location of drifting or sunken objects, such as containers or drums, the vessel is fitted with a retractable STN Atlas OSS 11Z sonar. Under normal sailing conditions, the 2m linear sonar is turned from the operational position and retracted into a trunk and aperture closed by a sliding ice door.

Firefighting off- and onboard

For off-board fire-fighting, the vessel is provided with two remotely-controlled 120m-range monitors. Two foam monitors with a 70m throw, switchable to water, are fitted.

Buoy tender operations

The ship is equipped with a working **crane** designed for handling buoys and salvaging containers. It has two lifting devices, each with a heave compensator, with a capacity for buoy lifting of 125kN at a radius of 15m. The crane pillar and cab are within the gas protection system. However, in hazardous atmosphere, it can be bridge-controlled.

Emergency towing

A Hatlapa towing winch comprises a 1000m towline stowage winch and a geared winch, with a friction brake set at 2000kN holding power, for paying out the towline. With both **rudder-propellers** and the pump jet in operation, the bollard pull exceeds 1100kN.

Length, oa: 78.61m, Breadth, mld: 18.00m, Draught, max/operating: 5.90/5.00m, Displacement: approx. 3830 t, Tonnage, gross/dwt: 3450/2040t, Propulsion, main/bow pump jet 2 x 2900kW/2600kW, Speed: 15 knots, Bollard pull: 1100kN.

Pollution containment and recovery equipment – Collection and subsequent pumping of viscous oil is difficult unless specially developed equipment is used for spill clean up. This includes oil containment booms, oil skimmers, sweeping arms to steer oil slicks towards the skimmers.

See also **Oil recovery system of HAVEN HORNBILL**.

For more information visit www.ro-cleandesmi.com, www.vikoma.com

Pollution control ships – The new generation of advanced coast protection vessels to deal with potential emergencies. Towing and pollution control ships are intended to prevent disasters such as the ERIKA and PRESTIGE pollution accidents happening again. They should have sufficient towing force to prevent a stricken vessel grounding or drifting ashore causing an oil spill, and a comprehensive oil recovery outfit. This includes oil booms and sweeping arms to direct floating oil to a variety of skimmer systems that can collect oil of different viscosities. They can have also other capabilities, including rescue, firefighting, salvage and support for divers.

See also **Oil spill combatment vessel ARCA, Oil spill recovery ship, Pollution and accident control ship NEUWERK**.

Polymer – A high molecular weight material created from lower molecular weight constituents by chemical reaction. Polymers with resinous characteristics are frequently used in paints.

Polyurethane – A resin with special characteristics. Paints based on polyurethanes are either one or two-pack, and they wear extremely slowly and are resistant to chemicals.

Polyurethane foam – A foam obtained from the reaction between the polyetherpolyol and the polyisocyanate. Thanks to its high insulation value, good compression strength and processability, the polyurethane foam is used for the insulation of cargo spaces on board trawlers, refrigerated and deep-freeze vessels.

Pontoon

Pontoon – A simple, non self-propelled and unmanned floating structure without hatchways in the deck except small manholes closed with gasketed covers.

Pontoon cover – A cover with both sides closed. This term is often misused as the alternative name for an open-girder **lift-away cover**.

Poop – A **superstructure** which extends from the **after perpendicular** forward to a point, which is aft of the **forward perpendicular**. The poop may originate from a point aft off the after perpendicular, (ICLL).

Port –

1. A harbour in which ships can load or discharge cargo.
Port means the area, through which ship traffic and maritime commerce flow or people are transported, including areas ashore (extending to intermodal and cargo storage areas) and on the adjacent water (to include anchorages and approaches), as defined by the designated authority.
2. An opening in the side of a ship.
3. The left-hand side of a ship when facing forward.

Port facility – A location where the ship/port interface takes place, including anchorages, berths, and approaches.

Port Facility Security Officer (PFSO) – Person designated as responsible for the development, implementation, revision, and maintenance of the port facility security plan and for liaison with the port authorities and **Ship Security Officers** and **Company Security Officers**.

Port of Registry (also referred to as hailing port) – The place where a ship is registered. It is shown on the stern of the vessel.

Port side – The left-hand side of a ship when looking forward. Opposite to starboard.

Portable decompression chamber – A unit intended for human occupancy under greater than atmospheric pressure conditions. It is installed on a vehicle such as a helicopter or truck. This chamber may be used for therapeutic purposes. See also **deck decompression chamber**.

Porthole, port light, sidescuttle – A circular opening in the ship side to provide light and ventilation. A hinged metal cover or **deadlight** can be clamped over to secure in heavy weather.



Sidescuttles are divided into three types: Type A (Heavy), type B (Medium) and type C (Light). The minimum requirement for type A is that it shall withstand a water pressure

head of 24m, 12m for type B and 6m for type C. Sidescuttles may be made for welding or bolting into the ship shell or bulkhead. They may be made with (type A and B) or without inside hinged deadlights (type C).

Position Mooring System – A system which keeps the **Floating Installation Vessel** on station. There are two types of position mooring systems: conventional **spread mooring** and **single point mooring**. The position mooring system includes mooring lines, connectors and hardware, winches, piles, anchors, and thrusters.

Post-weld heat treatment – Stress relieving operation carried out to reduce the stresses caused by welding. For general fabrication work it is only required when material thickness exceed 30-40mm.

Pot life – The period after mixing the components of two-component paint during which the paint remains usable.

Pour – The quantity of cargo poured through one hatch opening as one step in the loading plan, i.e. from the time the spout is positioned over a hatch opening until it is moved to another hatch opening.

Pour point – The pour point is the lowest temperature at which the fuel just flows thanks to its own weight.

Powder – A dry substance in the form of very small grains.

Power – The quantity of work done in a defined time or the rate of doing work. When unit work is done in unit time then a unit of power has been used. The unit of power is the watt (W).

Rated power of diesel engine – The maximum power output at which the engine is designed to run continuously at the rated speed between the normal maintenance intervals recommended by the manufacturer.

Power actuating system – The hydraulic equipment for supplying power to turn the **rudderstock**, comprising a **steering gear power unit** or units, together with the associated pipes and fittings, and a **rudder actuator**.

POWER-SAVING DEVICES

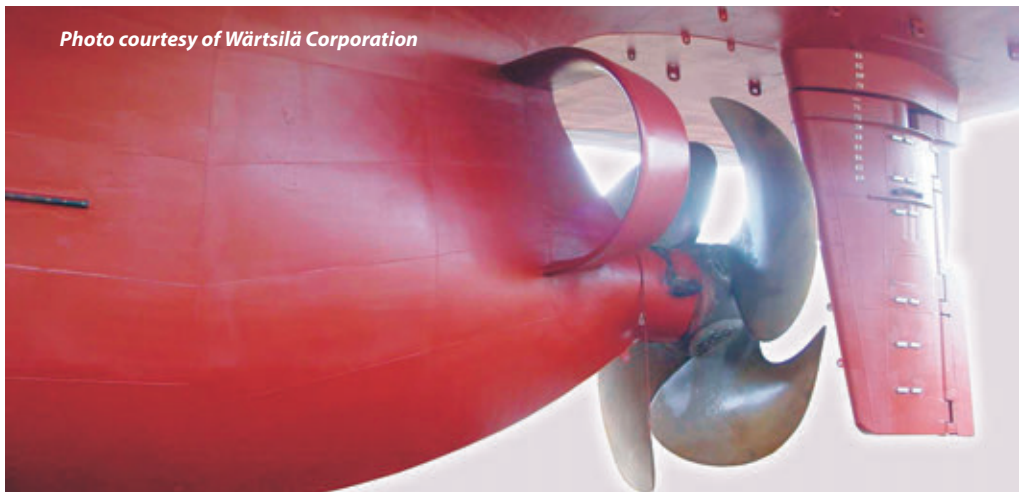

Schneekluth wake equalizing duct

The propulsion improving device, especially for full block ships, developed by Professor Schneekluth. It consists of two nozzle-shaped halfring ducts installed on both sides of the

stern ahead of the propeller. The duct accelerates the flow into the top half of the propeller plane and slow it down slightly in the lower part, thus achieving a more homogenous wake field.

Mevis Duct (Pre-Swirl Duct PSD)

This power-saving device consists of a wake equalising duct combined with an integrated pre-swirl fin system positioned ahead of the propeller. It reduces losses at the inflow to the propeller by equalising the inflow via the duct, reducing slipstream losses through the use of pre swirl fins and reducing hub vortex losses by increasing the propeller load at the inner radii.



The PSD is suited to vessels with high block coefficient and speeds lower than 20 knots. This encompasses tankers and bulk carriers of every size, together with multi-purpose carriers and feeder type container vessels. The expected power reduction is in the range of 3 to 9%, depending on the propeller loading, and is virtually independent of ship draught and speed. A beneficial byproduct of the PSD is a small improvement to the ship's yaw stability. Optimisation of the PSD is required on a ship-by-ship basis.

Propeller boss cap fins (PBCF)

The energy saving device developed by Mitsui OSK. It consists of a propeller boss fitted with short blades inclined to convert hub vortex energy into additional torque and thrust transmitted back to the shaft. Propulsion improvements of 4%-5% are claimed, based on extensive service experience. The elimination of propeller hub vortex results in reduced stern vibrations and lower propeller noise. It also solves a number of rudder erosion problems.

Reported gains have to be considered with caution as the rudder significantly reduces the hub vortex and hence the gain in propeller efficiency due to PBCF.



Grim vane wheel

Grim vane wheel is located immediately behind the propeller. Its diameter is somewhat larger than the propeller diameter so that only the inner part is located in the propeller stream. The vane wheel blades have turbine profiles in this inner section whereas they have propeller profiles at the outer blade section. In the turbine section, kinetic energy is taken from the propeller slipstream, which is directly transformed again within the propeller section into an additional thrust. In 1988 the world largest vane wheel: a freely rotating nine-bladed 11.65m dia propeller weighting 61t was supplied by Lips to IHI for installation behind the main propeller on 250,000dwt tanker.

Contra-rotating propellers (CRP) – Two propellers positioned in tandem on coaxial shafts that rotate in opposite directions. The after propeller of the pair is of smaller diameter to suit the contracting race column of the forward one. Higher efficiencies can be achieved with this propeller arrangement because no rotational energy needs to be left in the propeller **wake**. In 1988 the car carrier TOYOFUJI 5 was the first commercial vessel in the world to receive a CRP unit for evaluation purposes.

Ishikawajima-Harima Heavy Industries (IHI) has developed a large-sized contra-rotating propeller (CRP) system for container ships of between 4000 and 10,000TEU. After developing the large CRP system in 1988, IHI retrofitted it to the 37,000dwt bulk carrier JUNO the following year. Then, in 1993, the second system was fitted on the 259,000dwt VLCC OKINOSHIMA-MARU. This latest CRP was developed as a result of operational experience gained from these two vessels, but this one can work for twice as much transmission torque as that of a VLCC.



The model of Grim vane wheel at Hamburg Ship Model Basin

Podded CRP

The combination of the shaft-driven main propeller and the podded propulsor located on the same axis, but without any physical connection. The arrangement works as the contra-rotating propellers and is said to give an improvement of over 10% in hydrodynamic efficiency for an ultra-large containership. A 25/75 power split between the pod and the main propeller is the best option from the point of view of total efficiency. See also **CRP-Azipod propulsion of the ferry HAMANASU**.

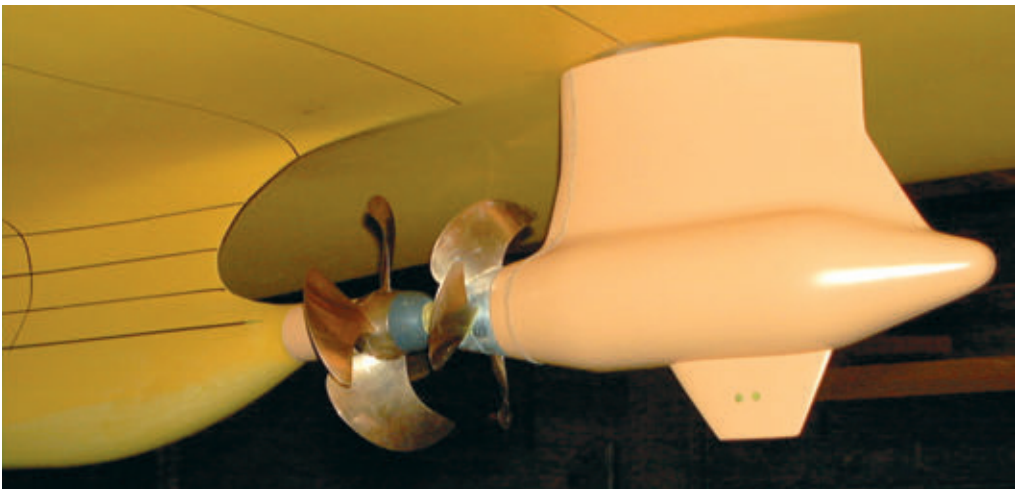

Hybrid Propulsion. Picture courtesy of Wärtsilä Corporation

Power supply installations – Installations for the generating, conversion, storage and distribution of electrical energy.

Power system of dynamic positioning system – All components and systems necessary to supply the DP system with power.

The power system includes:

- prime movers with necessary auxiliary systems including piping,
- generators,
- switchboards, and
- distributing system (cabling and cable routing).

Preferential tripping – The use of automatic switches to trip or disconnect non-essential loads from the **switchboard** in the event of overload.

Preheat – Preheat is used primarily to slow the cooling rate of a welded component in order to reduce the shrinkage stresses, prevent hardening and loss in ductility. It may be applied by propane gas torch.

Preoutfitting – The installation of both outfit and machinery items in large structural assembly units prior to these units being erected in the ship.

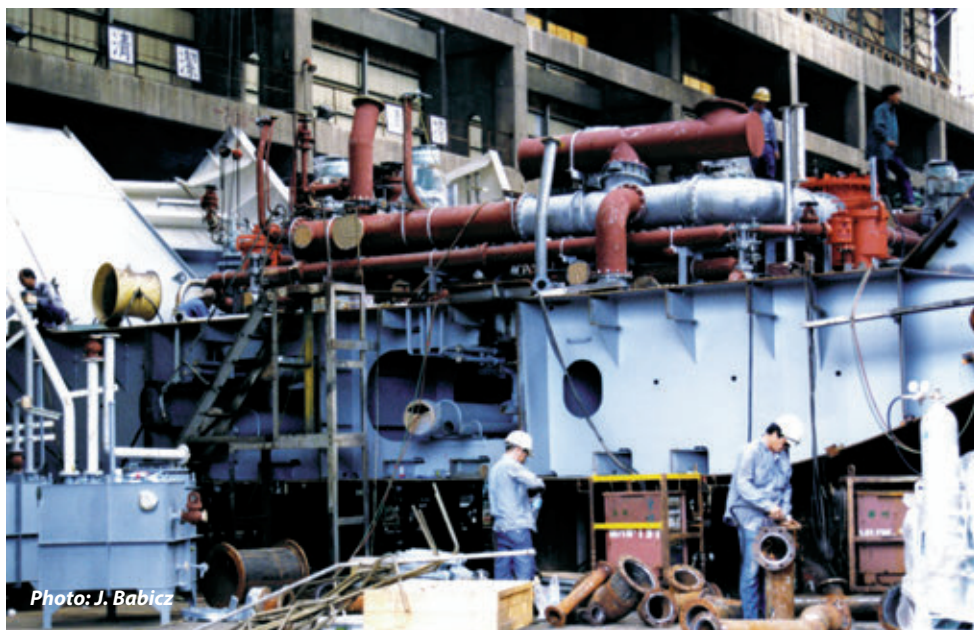

Pressure – The intensity of force or force per unit area. A unit of pressure exists where a unit of force acts on a unit of area. A unit of pressure is the Pascal (Pa), i.e. Newton per square metre.

Pressure chambers – Pressure chambers are installed on board **diving support ships**. Divers are accommodated inside, observed, medically checked and supplied. From these pressure chambers with precisely regulated breathing gas mixtures, the drivers are led via transfer chambers to the **diving bell** which is then lowered to the working depth. The processes of compression and decompression, lasting several days, take place inside the pressure chambers.

Pressure charging

Pressure charging – Increasing the density of the air charge usually accomplished on **diesel engines** by the use of exhaust gas turbobcharging.

Pressure surge – A sudden increase in the pressure of the liquid in a pipeline brought about by an abrupt change in flow velocity. The pressure surge may cause a rupture of the piping and an extensive oil spill.

Pressure swing absorption (PSA) – The technology of **inert gas** production by the removal of oxygen from air used on **LNG** tankers. The principle of the absorption system relies on the use of an absorbent carbon bed which collects selectively the oxygen molecule, leaving the nitrogen gas as a final product.



Photo: C. Spigarski

Pressure-vacuum valves on a chemical tanker

Pressure-vacuum valve (P/V valve) – A valve which keeps the tank over pressure or under pressure within approved, limits. P/V valve provides for the flow of the small volumes of vapour, air or inert gas mixtures caused by thermal variations in a cargo tank. The vacuum valve opens if the pressure in the tank falls below a pre-set level – to draw air into the tank through a flame trap. In the event of over-pressure, two release valves open to ensure that venting is upwards and at high velocity, to avoid concentrations of gas on deck.

Pressurised hold system – MacGREGOR's patented 'hold overpressure system' is a way of maximising the weathertightness of hatch covers. When the covers have been closed and cleated and all other openings including non-return drainage valves have been shut, the cargo hold is pressurised to a slightly higher pressure than the atmospheric one, to a maximum of 0.04 bar. All leaks caused by, for example, old sealing systems, or wear and tear in stoppers, can be prevented by pressurising the hold. The positive pressure is enough to ensure weathertightness even in case of several small leaks. Pressure in the hold is maintained by fans throughout the voyage – a relief valve ensures that the

pressure is kept at the correct level and a pressure gauge is fitted on the **bridge**. The system works with CAT-profile, Flexseal and sponge seals.

Fittings needed for the 'hold overpressure system' are:

- air fans (capacity depends on the hold size)
- shut-off valves for non-return drainage valves
- pressure relief valve to ensure the correct pressure level in holds
- pressure gauge for checking the correct pressure level.

Prewash – The mandatory wash of the cargo tanks prior to loading cargo.

Primary barrier of membrane containment system, primary membrane – The inner element designed to contain the cargo when the cargo containment system includes two barriers, (IGC CODE). See also **secondary barrier**.

Primary bridge navigational equipment/systems – Equipment/systems essential for performance of primary bridge navigational functions: **log, echo sounder, gyrocompass, radar**, position-fixing system and **electronic chart** system.

Primary members of the hull structure – **Floors** and bottom girders, side stringers and web frames, deck transverses and deck girders, vertical webs and horizontal stringers on bulkheads. Primary members support secondary stiffeners.

Prime movers – All machines that convert primary energy to mechanical energy for use in propulsion or electric supply systems, e.g. the diesel engine, the gas turbine and the steam turbine plant.

Primer coat or ground coat (painting) – The first coat of the coating system applied in the shipyard after shop primer application.

Produced fluids – Fluids coming out of **completed wells** which may consist of oil, water, gas, and condensable vapour.

Product tanker, product carrier – An **oil tanker** for carrying oil other than **crude oil**. See also **Tankers**.

Product tanker ANGELINA AMORETTI

According to **Significant Ships** of 2004

ANGELINA AMORETTI was built by Chinese shipyard Jiangsu Yangzijiang according to design from Kiel-based consultancy INEC GmbH. The vessel complies with ExxonMobil requirements, such as the fitting of suitable mooring arrangements and an ability to put 12 mooring lines ashore. Emergency towage facilities are provided forward and aft, and a 2000kN strong point is fitted forward.

Cargo is handled by a Hamworthy deepwell pump in each tank. Like the piping installation, they are made of stainless steel. A new system of super stripping, which leaves virtually no residuals, has been included, and particular attention paid to tank cleaning, with permanent tank-washing machines fitted.

Remote level, temperature, and pressure monitoring and control of each tank is carried out by Saab equipment which is linked to a Kongsberg/Norcontrol integrated automation system, and operated from workstation on the bridge, and in the cargo and engine control rooms. High-quality monitoring equipment serves the double-hull space and oil tanks. Fresh and dry-air ventilation lines are installed on deck, fitted with valves and connections for portable hoses.

The Wärtsilä 12V38B main engine has been selected developing 8700kW at 600 rev/min and driving a CP propeller by means of a vertically offset reduction gearbox that also joins with a 1200kW shaft-driven alternator. With the main engine de-clutched, this unit can serve

Product tanker

as an auxiliary motor for emergency propulsion in accordance with RINA notation AVM-APS, and produce a speed of 7 knots. Three 1000kW diesel-driven alternator sets are fitted and two 600kW bow thrusters and a semi-balanced rudder benefit manoeuvrability. Provision has been made for the future fitting of an SCR emission converter with urea plant in the funnel.

Length, oa: 162.00m, Length, bp: 154.37m, Breadth, mld: 26.00m, Depth, mld to main deck: 13.09m, Deadweight, design/scantling: 18,850/23,740dwt. Draught, design/scantling: 8.20/9.50m, Main engine output: 8700kW at 600rev/min, Service speed: 15.80knots.

Photo: P-H. Sjöström



3515dwt product carrier VEDREY TORA LBP = 75.00m, Bmld = 15.70m, Dmld = 7.80m

VEDREY TORA has the main engine Wärtsilä 6L26 running on gas oil, MCR = 2025kW, service speed 12.5 knots.

Product tanker; Tank cleaning – Tank cleaning may be required for one or more of the following reasons:

1. To carry clean ballast.
2. To gas free tanks for internal inspections, repairs or prior to entering dry dock.
3. To remove sediment from tank top plating. This may be required if the vessel is engaged in the repetitive carriage of fuel oil or similar sediment settling cargoes. Although washing may not be necessary between the consecutive voyages, assuming the cargoes are compatible, many Ship Owners have found it prudent to water wash a small group of tanks on a rotation basis between voyages, thus preventing any large accumulation of sediments.

4. To load a different and not compatible grade of cargo.

Washing between different grades of cargo is the most common reason for tank cleaning. In most cargo sequences on product tankers, this cleaning may consist of no more than a simple hot or cold seawater wash. A simple water wash will disperse many types of chemicals and has been found effective between clean petroleum products such as gas oil and kerosene. However, it should be noted that there is a number of grade sequences, particularly in the petroleum products trade, where no

washing at all needs to be carried out. Thus, the decision for necessary tank cleaning required in such trades is often made only when knowledge of the next grade to be loaded is obtained.

Washing machines, their water supply and even the washing method are usually described by the term "Butterworth". The machines, either fixed or portable, consist of revolving nozzles, which are moved by water driven gearing to create a spherical wash pattern or "cycle".

With portable machines, both the machine and its flexible water supply hose are placed into the top of the tank to be cleaned through an opening called the "Butterworth Port". The machines are progressively lowered down the height of a tank in stages or "drops" each usually of 10-15 feet. Graduation marks every 5 feet on the water supply hose are a useful check on the depth of the machine inside the tank. The lowest "drop" is normally about 5 feet above the "bottom" of the tank where the machine is positioned for a "bottom wash". The wash duration at each drop is usually for one cycle of the machine, the cycle time varying between 30-60 minutes according to the size of the machine and its pump pressure.

Throughout the washing operation, cargo residues mixed with washing water are continuously stripped from the cargo tanks by the vessel normal cargo pumps. These washings are directed through the cargo line system into reception tanks, a slop tank or in some cases to shore facilities.

Product tanker STENA PARIS

According to **Significant Ships** of 2005

Claimed to be the safest and most efficient medium-range tanker, STENA PARIS is the first unit of a new series of P-MAX product tankers built by Brodosplit Shipyard. The principal aim of the design is to minimise the risk of incidents by including a double hull throughout, an **integrated bridge** system, twin engine rooms with full fire and water integrity, and separate systems for propulsion, steering, and automation.

STENA PARIS is a shallow-drafted and extremely wide vessel. At the design draught of 11.3m, the vessel can carry about 30% more cargo than a conventional tanker.

The double hull surrounds a cargo space divided by corrugated **bulkheads** into five pairs of tanks arranged for clean and dirty oil products and crude oil. An Effective Tank Cleaning notation from DNV signifies the inclusion of equipment allowing a rapid turnaround. The cargo tanks are equipped with new Svanehoj CKL 300 electrically-driven deepwell cargo pumps (10x 800m³/h). The slop tanks are equipped with 300m³/h pumps.

The vessel has two engine rooms. Each of them contains engine producing 7860kW at 129 rev/min directly coupled with FP propeller and two 1081kVA diesel generators. Each main engine is served by separate fuel supply and auxiliary systems. Steam requirements are derived from two oil-fired and two exhaust-gas boilers.

The 360-degree free view bridge features five multi-functional workstations from where two navigators have access to all the information needed. The display on workstations can be used for navigational purposes – such as radar displays and **ECDIS** with radar overlay and conning information – or to monitor and control cargo and ballast operations, and to monitor all engine systems.

Another important issue for safety is hull strength: the vessel is designed for a 40 year life span and built to Swedish/Finnish ice class 1B for trading in the icy waters.



Length, oa: 182.90m, Length, bp: 175.50m, Breadth, mld: 40.00m, Depth, mld to main deck: 17.90m, Draught, design/scantling: 11.30/13.00m, Deadweight, design/scantling: 54,0001/65,200dwt, Cargo capacity: 70,200m³, Main engine output: 2x7860kW at 129rev/min, Service speed: 14.50knots, Complement: 26.

Production facilities – The processing, safety and control systems, utility and auxiliary equipment, for producing hydrocarbon liquid and gas mixtures from **completed wells** or other sources.

Production tubing – A pipe used in **wells** to conduct fluid from the producing formation into the **Christmas tree**. Unlike the **casing**, the tubing is designed to be replaced during the life of the well, if required.

Profile – A side elevation of a ship form.

Progressive collapse – The gradual collapse of the hull girder, involving the spread of elasto-plastic **buckling** throughout a transverse section, following which the vessel is no longer capable of sustaining any longitudinal bending loads. In certain cases, progressive collapse may be followed by break-up of the vessel into two sections.

Projected area of a propeller – This is the sum of the area bounded by the outline of the blades when projected onto a plane perpendicular to the axis of the screw.

Prompt and thorough repair – Permanent repair completed at the time of the **survey** to the satisfaction of the **surveyor**, therein removing the need for imposition of any associated condition of **class**.

PROPAC (propulsion package) – An integrated mechanical propulsion system developed by Wärtsilä as a single supplier with commitment to lifetime support. The main component of the system is a Wärtsilä L20 engine driving through reduction gear Lips CP propeller or Lips compact thruster.

WÄRTSILÄ PROPAC ST

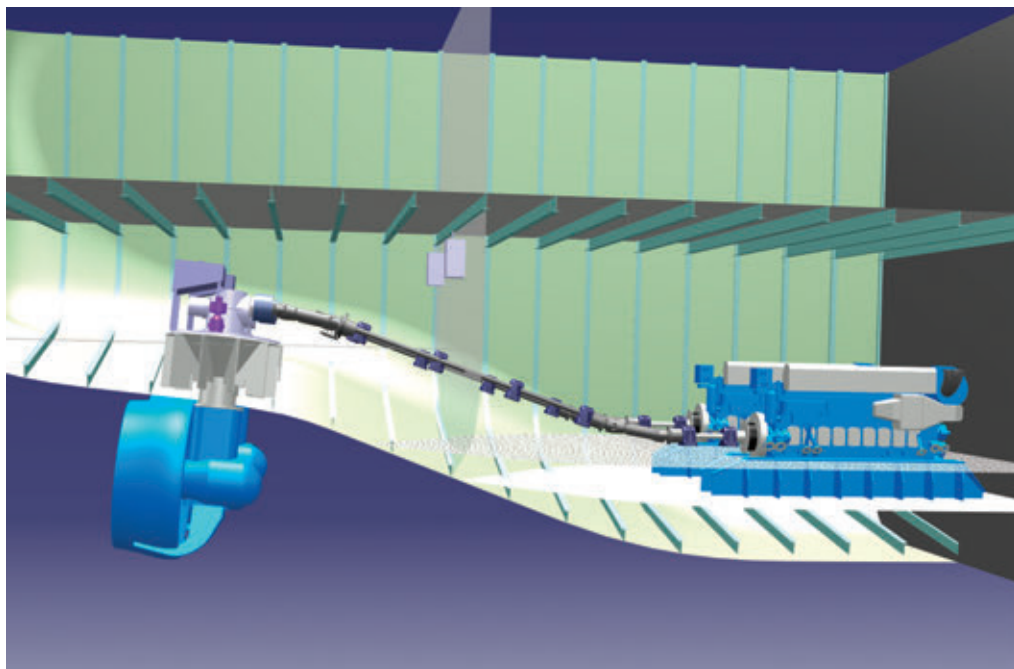

Propac ST (steerable thruster) in a tug

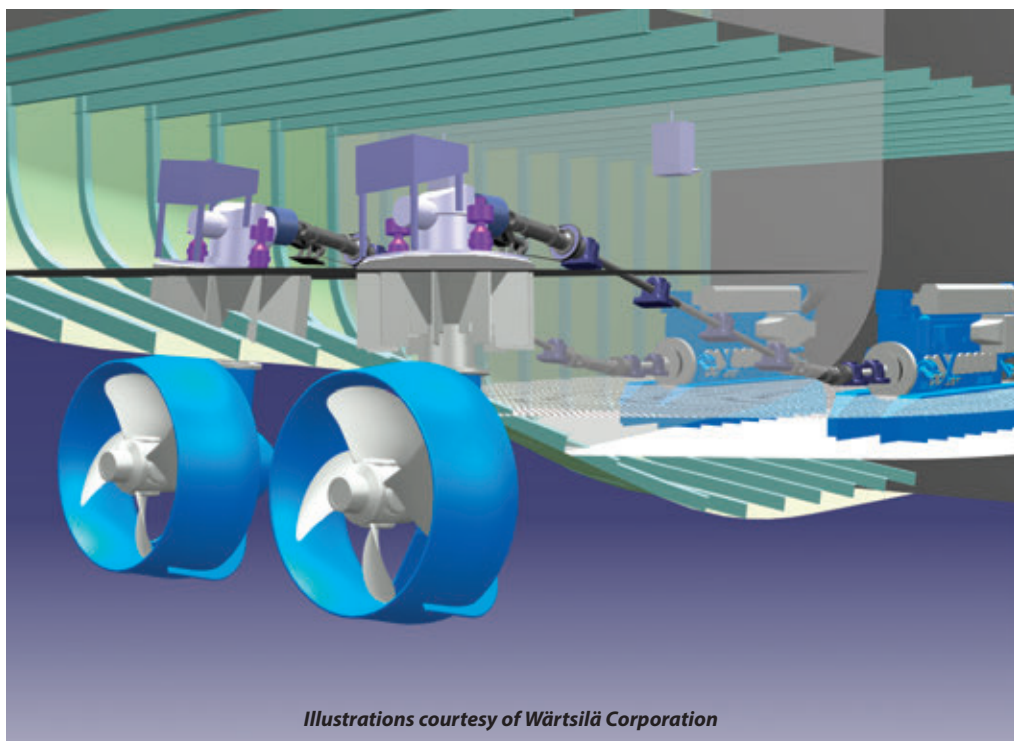

Illustrations courtesy of Wärtsilä Corporation

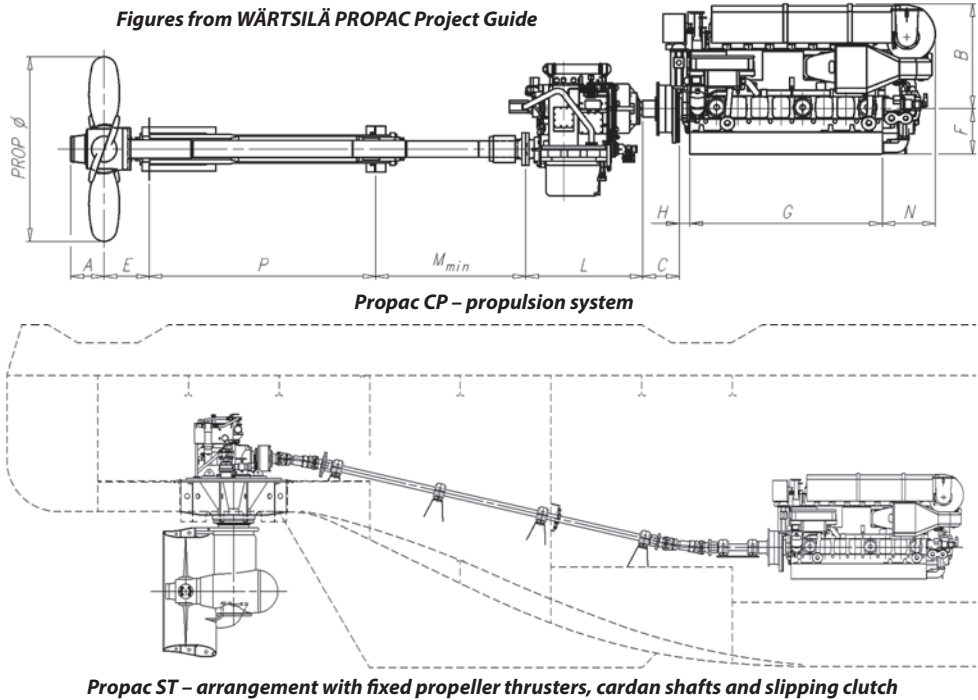

Propac CP = Wärtsilä L20 engine and reduction gear, Lips CP propeller and Lipstronic controls.

Propac ST = Wärtsilä L20 engine and reduction gear, Lips compact thruster and Lipstronic controls.

Propeller, screw propeller – A revolving screw-like device that drives the ship. The screw-type propeller consists of a hub and blades, all spaced at equal angles about the axis. When the blades are integral with the hub, the propeller is known as a solid propeller. When the blades are separately cast and secured to the hub by studs, the propeller is known as a built-up propeller. The face (or pressure face) is the afterside of the blade when the ship is moving ahead. The back (or suction back) is the surface opposite the face. As the propeller rotates, the face of the blade increases pressure on the water to move it in a positive astern movement. The tip of the blade is the most distant from the hub. The root of the blade is the area where the blade joins the hub. The leading edge is the edge that cuts water first when the ship is going ahead. The trailing edge (also called the following edge) is opposite the leading edge. A rake angle exists when the tip of the propeller blade is not precisely perpendicular to the axis (hub). The angle is formed by the distance between where the tip really is (forward or aft) and where the tip would be if it were in a perpendicular position.

A screw propeller may be generally classified as either fixed pitch or controllable pitch. The pitch of a fixed-pitch propeller cannot be altered during the operation. The pitch of a controllable-pitch propeller can be changed at any time, subject to bridge or engine-room control. The controllable-pitch propeller can reverse the direction of a ship without requiring a change of direction of the drive shaft. The blades are mounted so that each one can swivel or turn on a shaft that is mounted in the hub.

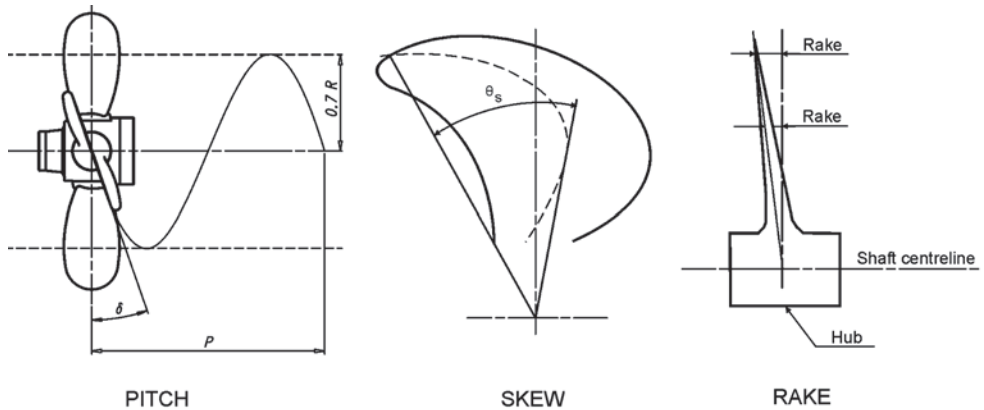

Figure courtesy of Wärtsilä Corporation

The thrust and torque of a propeller are created by the pressure differences on either side of the blades, which is related to relative velocity and blade geometry. The relative velocity is a function of the rotational speed (and radius) and the speed of water in the ship's wake. Reducing the propeller speed and increasing its diameter also increases the efficiency.

In 1997, the heaviest propeller ever manufactured as single castings was supplied by Stone Manganese Marine. The six-bladed fixed pitch propeller was designed to absorb 65.9 MW, it has a diameter of 8950 mm and weighs 93.5 tonnes.

Adjustable bolted propeller (ABP) – Similar in concept to a standard **controllable pitch propeller**, the ABP is based on a hollow hub with blades bolted to it from the inside. In service, the slotted holes on the hub allow the blade pitch angle to be adjusted to compensate for long-term variations in hull resistance. If the propeller is damaged, individual blades can be replaced without drydocking, and only spare blades have to be stocked rather than a bulky monobloc propeller.

Assembled propeller, built-up propeller – A propeller cast in more than one piece. In general, built-up propellers have the blades cast separately and fixed to the hub by a system of bolts and studs.

CLT propeller – The contracted and loaded tip propellers, developed by Spanish company Sistemar (www.sistemar.com) in the late 1980s: screw propellers with important load at the blade tips due to the fitting of end plates at the blade tips. As well as a higher efficiency, CLT propeller also offers lower noise and vibration, lower fuel consumption and better **manoeuvrability**.

Contra-rotating propellers (CRP) – see **POWER-SAVING DEVICES**

Controllable-pitch (CP) propeller – A propeller with a mechanism in the propeller hub that can be operated remotely to change the **propeller pitch** setting from a maximum design ahead pitch to a maximum design astern pitch. The pitch can be changed while the propeller rotates and develops thrust within these limits, or the pitch can be maintained at any intermediate setting for continuous operation.

CP propellers are almost standard requirements on ferries and cruise liners where their handiness in manoeuvring and compatibility with highly-skewed blades for noise and vibration reduction is important. Applying full astern power on a highly-skewed FP screw can lead to stress problems, whereas the CP type, turning always in the same way and achieving astern thrust by pitch reversal, avoids problems.

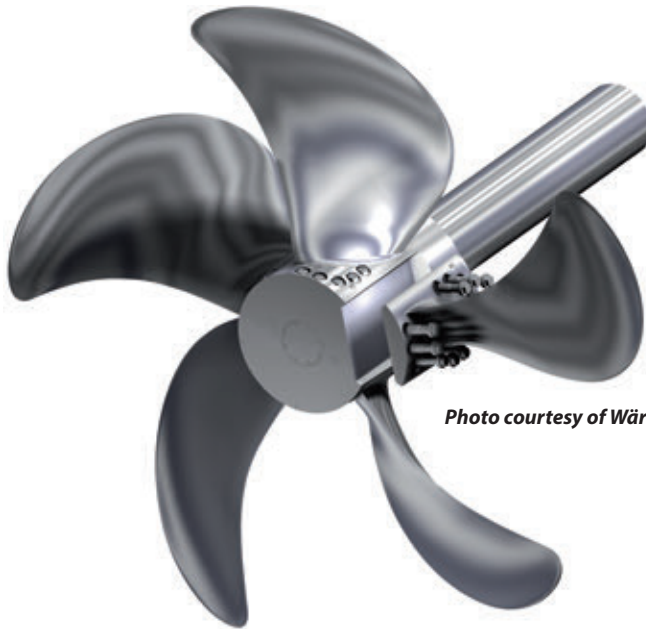

Photo courtesy of Wärtsilä Corporation

Stainless steel built-up propeller

Ducted propeller, shrouded propeller – The propeller placed in a duct, i.e. a ring with a cross section that has a wing-like profile. The duct offers protection to the propeller blades and contributes to the thrust generated by the propeller. The same amount of thrust can be generated from a propeller of smaller diameter, making it a suitable solution for small-draught vessels. See also **Propeller nozzle**.

Fixed pitch (FP) propeller – Propeller with blades rigidly attached to the hub.

High skew propeller – A propeller of **skew angle** more than 25° . A high skew blades are applied to suppress cavitation-induced pressure impulses. By skewing the blade, it is possible to reduce the vibration level to less than 30% of an unskewed design. The skew distribution is of the “balanced” type, which means that the blade chords at the inner radii are moved forward, while at the outer radii the cords are skewed aft. As the skew does not affect the propeller efficiency, it is a standard design on vessels where low vibration levels are required.

Keyless propeller – A fixed pitch propeller that is press-fitted on the shaft cone. No keyway with its stress concentration is present. See also **Fitting of keyless propeller**.

Solid propeller – A propeller (including hub and blades) cast in one piece.

Surface piercing propeller – A propeller that is positioned so the **waterline** passes right through the propeller hub. Each propeller blade is out of the water for half of every revolution. The main reasons for using a surface piercing propulsion system are better propeller efficiency, reduced appendage drag, lack of cavitation and shallow draft.

Propeller boss cap fins (PBCF) – see **POWER-SAVING DEVICES**.

Propeller clearances – The distance from the propeller to the hull has a linear influence on the pressure impulses. A reduction of this clearance by 50% doubles the pressure impulses. To account for the ice class it is necessary to increase the thickness of blade

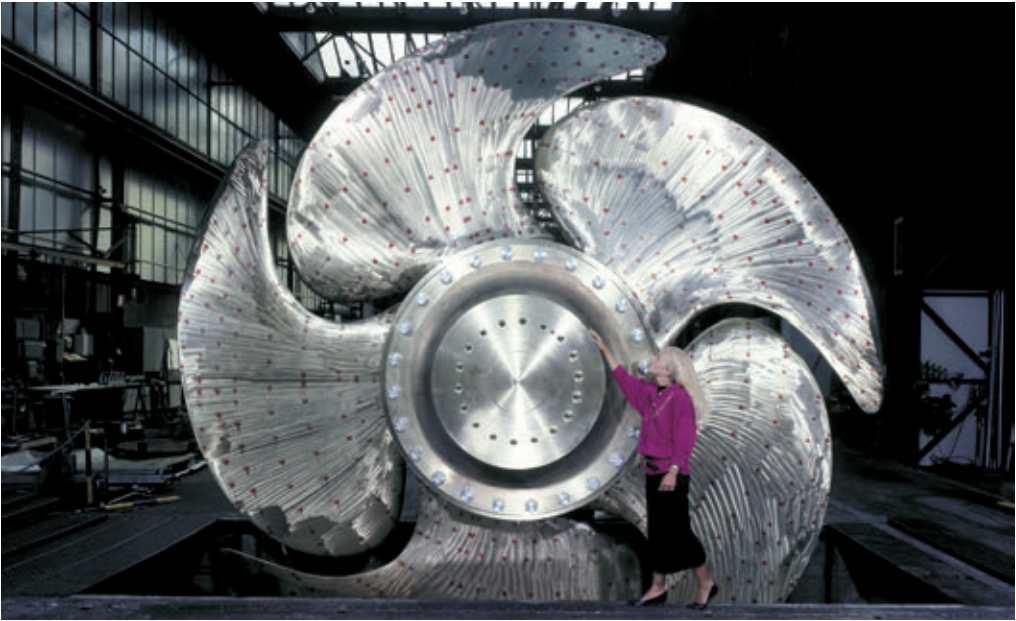

The world's most powerful CP propeller, installed on the Queen Elizabeth 2, 44 MW at 144 rpm, the propeller diameter is 6m, the hub diameter 2.0m

sections. This increases the propeller induced pressure impulses. To avoid transferring vibration to the hull, the distance from the blade to the different part of the hull must be kept above certain minimum limits. Guidance figures for open propellers with moderate power density and no special noise requirements apply a tip clearance which is 20-25% of the propeller diameter for non-skew propeller or 15-20% of D for high skew propeller. The lower values can be used for ships with slender aft body and favourable inflow conditions whereas full after body ships with large variations in wake field require the upper values to be used.

For ferries and cruise liners the tip clearance is normally 25-30% of D .

Base line clearance minimum is 50-100mm. In twin-screw ships the blade tip may protrude below the base line.

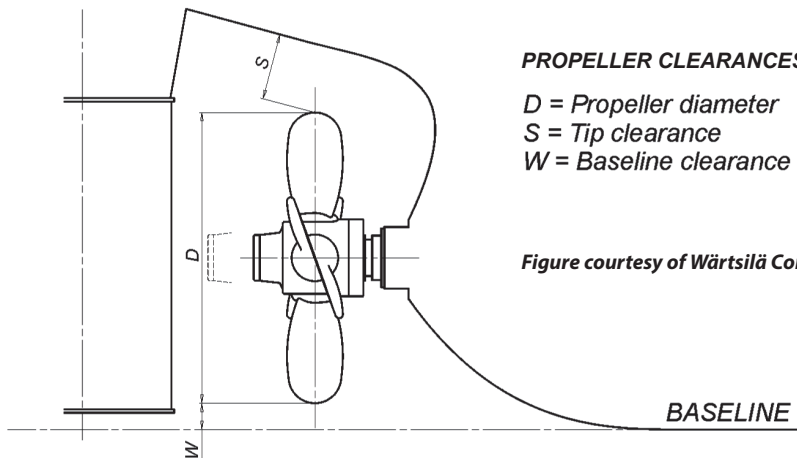

Propeller diameter

Propeller diameter – The largest possible propeller diameter is preferred in order to obtain the highest possible propulsive efficiency. The necessary clearance between the tip of the propeller and the hull, and/or demand that propeller shall be fully immersed in ballast condition, creates some limitation to the propeller diameter.

Propeller excitation forces – The propeller is a potential source of noise and vibrations in a ship. The vibration of a propeller are strongly related to the variation in inflow velocity (**wake-field**), the clearance from propeller tip to hull surface and blade geometry. The hull form should be optimised to make the wake-field as uniform as possible. Sufficient clearance to the hull must be provided. Adding skewback to the propeller gives less load variation and cavitation on the propeller blades. For given conditions the pressure pulses can be minimised using tip off-loading (reduced pitch at the tip) and skew.

Propeller hub (of CP propeller) – The hub is bolted to the flanged end of the tailshaft. Without ice class, the hub diameter/propeller diameter ratio varies between 0.20 and 0.25. A typical hub ratio for ice class or very high-loaded propellers may vary from 0.25 to 0.38 or higher. The propeller blades are bolted to the propeller crank disk which is connected to the pitch setting mechanism inside the hub. The hub is filled with pressurised oil from the gravity tank located above the water line. The pressure inside the hub is larger than outside, which prevents water leakage into the hub. Small controllable pitch propellers have a push-pull rod from the mechanism in the hub and forward to the gearbox or in the shaftline. Such a solution is recommended because of its simplicity and well-proven functionality. Larger propellers have the servo cylinder incorporated into the hub.



Photo courtesy of Wärtsilä Corporation

Propeller shaft with CP hub

Propeller nozzle – A circular casing enclosing the propeller. The propeller operates with a small gap between blade tips and the nozzle internal wall, roughly at the narrowest point. The nozzle ring has a cross-section shaped like a **hydrofoil**. The nozzle increases the thrust at low speeds. The Wärtsilä high efficiency nozzle increases bollard thrust up to 30% at low vessel speeds. Tugs, fishing vessels, dredgers, and inland waterway vessels, which typically have heavily loaded propellers, will gain more thrust under these demanding conditions. Some types of general cargo vessels with relatively low sailing speeds might also benefit from installing a nozzle.

Propeller pitch – The distance that a propeller theoretically (i.e. without slip) advances during one revolution. Each radius of the blade can have a different pitch and therefore the pitch at $r/R = 0.7$ is often used as a representative value (the nominal pitch). The pitch ratio of a propeller is the mean pitch divided by its diameter. See also **Propeller**.

Propeller rake – It is the distance at the blade tip between the generating line and the line perpendicular to the propeller axis that meets the generating line at the propeller axis.

Propeller shaft, tail shaft – The aftermost section of the propulsion shafting in the stern tube in single screw ships and in the struts of multiple screw ships to which the propeller is fitted.

Propeller shaft coupling flange – For connecting the propeller shaft with the intermediate shaft, a hydraulic coupling flange is used. To fit the flange, high-pressure oil of more than 2000 bar is injected between the muff and the coupling flange by means of the injectors in order to expand the muff. By increasing the pressure by the hydraulic pump, the muff is gradually pushed up the cone. Longitudinal placing of the coupling flange as well as the final push-up of the muff is marked on the shaft and the muff.

Propeller skew angle – Skew angle of a propeller is the angle measured from ray "A" passing through the tip of the blade at mid-chord line to ray "B" tangent to the mid-chord line on the projected blade outline. See also **Propeller**.

Propeller surface finish – A propeller surface finish has big effect on fuel consumption. A surface finish of 70 microRa will add over 4.5 per cent to the fuel consumption bill compared with one of 10 microRa. A super-smooth surface (1 microRa or better) is inhospitable to marine organisms as well as beneficial to the efficiency of the propeller. Most propellers have a finish between 2 microRa and the 6 microRa laid down in the ISO specification.

It is desirable and cost effective to polish the entire surface of the propeller blades, but 75% of the benefit is obtained by polishing the outer half and leading edges of the blades. UMC International has introduced an underwater polishing technique to produce the surface finish of 0.5 microRa.

Propulsion Condition Monitoring Service

In August 2010, Wärtsilä introduced its Propulsion Condition Monitoring Service (PCMS) for all types of propulsion machinery. This service aims to provide the customer with information about the condition of his propulsion equipment.

To provide this service, a PCMS system consisting of the following items has to be installed onboard the vessel:

PCMS advisory monitor

One or more PCMS cabinets, each with the following as standard:

– 6 accelerometers (50kHz)

– 4 pressure (50Hz) transmitters

Propulsion Condition Monitoring Service

- 2 temperature transmitters
- oil monitoring unit
- torque (100Hz) measurement system.

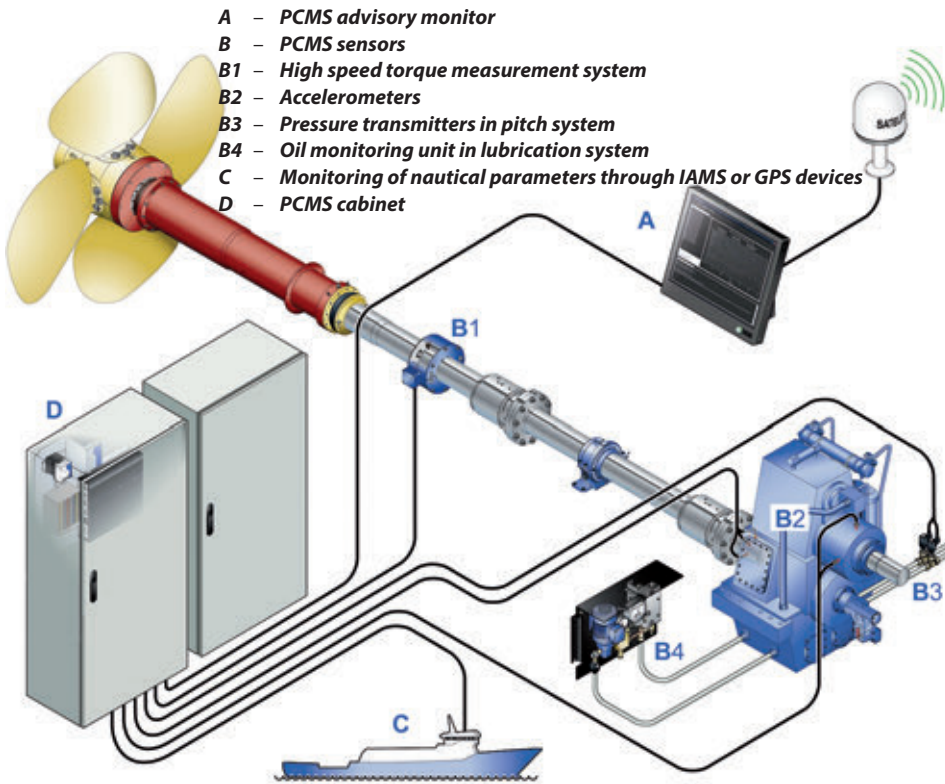

The number of inputs can be changed depending on the specific requirements. Accelerometers are used to monitor the condition of mechanical parts, such as gears and bearings, but can also detect for example, blade damage. One PCMS system can process up to 16 accelerometers simultaneously. Lubrication and hydraulic oil is monitored by measuring temperature, the oil-water saturation, and any oil contamination.

The PCMS advisory monitor is the next evolutionary step in vessel automation. The interface gathers and shows information from all the PCMS cabinets on the vessel. It gives real-time and trend values, and advises the operator in case of irregularities. It has been developed to detect the operational states by real-time comparisons of parameters from multiple sources. For example, the vibration measurements are linked to the operational condition of the vessel. If an operational state causes severe vibration, the PCMS will advise how to rectify this unwanted situation. The advisory monitor sends a data package to the propulsion CBM (Condition Based Maintenance) centre on a daily basis. There the data is automatically processed, and in the event of irregularities, the propulsion specialist will take relevant action.

Once a month, the customer receives a PCMS report describing the condition of his equipment. To effectively analyse the data and to ensure that no important events have been overlooked, a large part of the data analysis is automated.

Further reading: In Detail issue no. 02/2010

Propulsion shafting – A system of revolving rods that transmit power and motion from the main drive to the propeller. The shafting is supported by an appropriate number of bearings.

Propulsion system, propulsion plant – A system which provides thrust to propel the ship. It consists of propulsion machinery and the auxiliary systems needed to operate them, all the equipment to transmit propulsion power into thrust and all the requisite monitoring and control systems, alarms and safety systems.

Azimuth propulsion system – A combined system for steering the ship and providing propulsion power. Podded drives, rudderpropellers, rotatable waterjets and Voith-Schneider cycloid propulsors are regarded as azimuth propulsion systems.

Propulsors – Various devices used to propel ships: paddle wheels, screw **propellers**, **thrusters**, **waterjets**. For ocean-going ships various types of screw propellers have almost exclusive application.

Protection and Indemnity Clubs (P&I Clubs) – The Clubs are associations of shipowners and charterers, owned and controlled by the insured shipowner or charterer “Members”. They operate on a non-profit mutual basis, that is to say the Members pool their resources together in order to meet losses suffered by each individual Member. The basic principle is that the contributions (“calls”) paid by the Membership in relation to any single year should be sufficient to meet all the claims, reinsurance and administrative expenses of the Club for that year. The mutual system is therefore very different from most of other forms of insurance, where the aim of the insurance company in accepting business is to make a profit for its shareholders.

Fourteen non-profit making clubs come under the umbrella of the International Group of P & I Clubs. They have taken after 90% of the world’s shipping, insuring them against claims for damages or marine accidents. Homepage: www.standard-club.com

Protectionism – Flag state protection of own shipping by the elimination of certain competitive elements.

Provision stores – Refrigerated stores intended to preserve perishable foods for shipboard use. Calculation of sufficient storage for food can be based on the estimated mass and associated volume of food consumption of:

Dry provisions: 1.5kg person/day (approximately 0.06m³).

Chilled provisions: 1.4kg person/day (approximately 0.017m³).

Frozen: 1.1kg person/day (approximately 0.023m³).

Public address system – Loudspeakers in cabins, mess rooms, etc., and on deck via which important information can be broadcast from a central point, mostly from the **navigation bridge**.

Public spaces – Those portions of the accommodation which are used for halls, dining rooms, lounges and similar permanently enclosed spaces, (**SOLAS**).

Pump – A machine used to raise liquids from a low level to a higher one, or to provide liquid with an increase in energy enabling it to flow or build up a pressure.

Marine pumps fall into two classes:

1. Displacement (reciprocating and **rotary pumps**).
2. Centrifugal.

Reciprocating and rotary pumps are self-priming and can deal with liquid from a level below the pump. Centrifugal units require to be primed if the liquid is below the pump.

Axial flow pump – A centrifugal pump which uses a screw propeller to accelerate the liquid axially. It is effectively a propeller in a tube. A large volume flow of liquid at low pressure is produced.

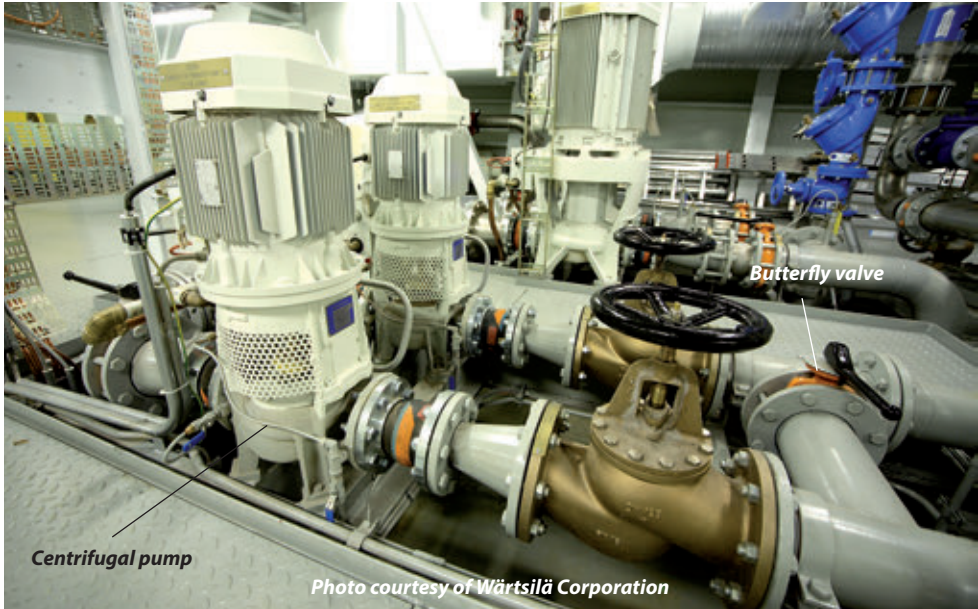

Centrifugal pump – It develops its pressure as a result of centrifugal force. Liquid enters the centre of the impeller and flows radially out between vanes. Its velocity being increased by the impeller rotation. It escapes through a discharge pipe at the circumference of the casing.

Pumps of this type operate at comparatively high speed usually directly connected to their driver. They are used where large volumes at relatively low pressures are required. They run as fresh or seawater cooling pumps, general service, boiler feed, ballast, fire-fighting or as lubricating oil pumps. Centrifugal pumps are not self-priming except for some very special designs.

Centrifugal pumps may be classified in several ways. For example, they may be either single-stage or multi-stage. A single-stage pump has only one impeller; a multi-stage pump has two or more impellers housed together in one casing. In a multi-stage pump, each impeller usually acts separately, discharging to the suction of the next-stage impeller.

Centrifugal pumps are also classified as horizontal or vertical ones, depending on the position of the pump shaft. Impellers used in centrifugal pumps may be classified as single-suction or double-suction, depending on the way the liquid enters the eye of the impeller. The single-suction impeller allows liquid to enter the eye from one side only; the double-suction impeller allows liquid to enter the eye from both sides. The double-suction arrangement has the advantage of balancing the end thrust in one direction with the end thrust in the other direction.

Displacement pump – A pump operating by the reduction or increase in volume of a space by a mechanical action which physically moves the liquid or gas.

Reciprocating pump – A pump in which a plunger or piston is mechanically reciprocated in a liquid cylinder. The reciprocating pump has positive pressure characteristics and is used principally to handle small volumes at relatively high pressures. Due to its reciprocating motion and the inertia effect of the parts, speeds are relatively low. This type of pump is self-priming and the delivered capacity is practically constant regardless of discharge pressure.

Pump room – A space, located in the **cargo area**, containing pumps and their accessories for the handling of ballast and fuel oil.

Pumpman – The unlicensed member of the engine department. He is trained in all skills necessary to engine maintenance. Usually watchstander, but on some ships a day worker. On tankers, a pumpman operates pumps and discharges petroleum products. He maintains and repairs all cargo handling equipment.

Pure car/truck carrier (PCTC) – The PCTC is a purpose-built vessel for the transportation of different types of rolling cargo, such as new private cars and trucks, heavy construction equipment, and other heavy loads. The vessels are usually configured with 10-13 decks for the loading of different vehicle types; axle loads varying between 1.2 tonnes and over 22 tonnes.

PureVent system – Alfa Laval's compact air separator designed to remove oil mist from crankcase gases with a cleaning efficiency of 99%. Occupying 30 litres of space in handling any engine size, the system reportedly has low power consumption and is maintenance-free. The oil is returned to the sump via a drainpipe, thereby reducing losses and releasing only clean air to the atmosphere.

Purging of cargo tanks with inert gas – The introduction of inert gas into a tank already in the inert condition, with the purpose of further reducing the existing oxygen content; and/or reducing the existing hydrocarbon gas content to a level below which combustion cannot be supported if air is subsequently introduced into the tank.

Purification – Separation of two intermixed and mutually insoluble liquid phases of different densities. Solids having a higher density than the liquids can be removed at the same time. The lighter liquid phase (oil), which is the major part of the mixture, shall be purified as far as possible.

Purifier – A separator that cleans the oil from water and solid particles with continuous removal of separated water.

Purse seiner – A fishing vessel catching **pelagic species** by surrounding the shoals with purse seines. Since purse seiners must be able to manoeuvre close to the net without fouling the **propeller**, most of them require the assistance of a powered **skiff** or of a small towboat.

Purse seiner/trawler LIBAS

According to **Ship and Boat International** May/June 2004

Norwegian shipyard Fitjar Mek Verksted AS completed the 94m fishing vessel LIBAS according to the design from Vik-Sandvik AS, who developed a new hull form for a speed of 20 knots in loaded conditions. The hull was built at the Vyborg Shipyard in Russia and brought to Norway for fitting out.

The LIBAS can operate as a pelagic trawler with gear handled over the stern. However, the main feature is a revolutionary purse seine handling layout. Instead of having the purse seine bins located on the starboard quarter, the purse seines are stowed under cover directly



Picture courtesy of Vik-Sandvik AS

below the round **wheelhouse**. The wheelhouse features a transparent floor, so the stacking operations can be monitored by the skipper.

A net stacking crane extending over both of the net bins is fitted in the roof of the net chamber, mounted on a fore and aft, hydraulically-operated transport system with an 8.50m traverse. This has a horizontal crane at its centre, capable of covering a 360deg arc and fitted with a 6t winch and a net roller with a 6t pulling power.

Triplex's largest available roller, the TR-160 intermediate roller unit with 6tonne pull is mounted inside the forward bulkhead. It is adjusted to the net stacking crane by mowing the roller vertically to avoid any rotation of the net when hauling.

Propulsion system supplied by Wärtsilä consists of 12V32 main engine, which drives through a gearbox a 4000mm CP propeller in a nozzle. The LIBAS is fitted with Brunvoll retractable azimuth **thrusters** forward that can be used when pursing, trawling, or as a diesel-electric propulsor. The ship is also provided with a stern thruster.

Length oa: 94.0m, Length bp: 82.4m, Breadth mld: 17.60m, Depth to 2nd deck 7.10m, Depth to 1st deck: 9.80m, RSW: 2300m³, Fuel oil: 1250m³, fresh water: 120m³, MCR: 6000kW, cruising speed: 19 knots.

Q.M.E.D. (Qualified Members of the Engine Department) – **Pumpman** and Electrician. Trained in all crafts necessary for engine maintenance (welding, refrigeration, lathe operation, electricity, pumping, water purification, oiling, evaluating engine gauges, etc.) They are usually watchstanders, but on some ships also day workers.

Quarter deck – A raised upper deck at the after end of a ship. It is usually a feature of smaller vessels.

Quay – An artificial solid construction, alongside or projecting into a harbour or basin, which acts as a landing place for cargo and passengers. It may also function as a fitting out or repair place for a ship moored alongside.

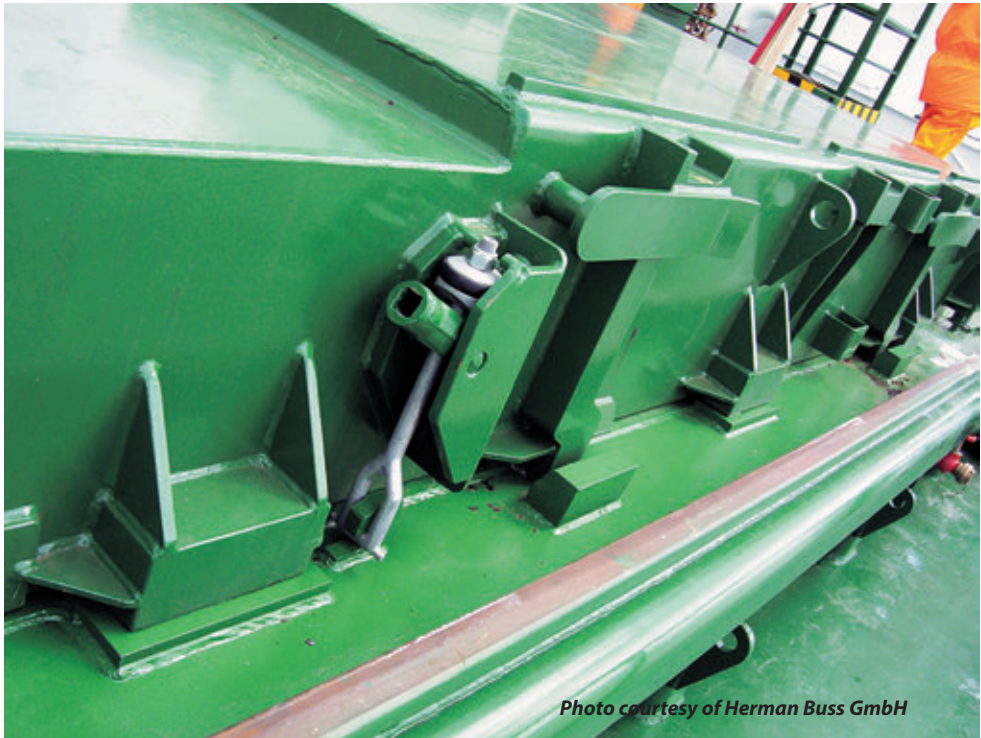

Photo courtesy of Herman Buss GmbH

Quick-acting cleat, battening device – A cleat applied manually by a lever to provide the necessary locking. **Hatch covers** are secured to the coaming by quick-acting cleats. The cleat consists of an eyebolt and a cam. The length of the cleat is adjusted by a nut. The necessary resilience is produced by a rubber washer being compressed in between steel washers.

Rack – A bar with cut teeth for engaging into a pinion. A linear motion of the bar is then converted into a rotary motion of the pinion. Rack-and-pinion drive systems are used for driving side rolling hatch covers, gantry cranes, ect.

Rack wire – A variant of the rack and pinion system in which only one panel is propelled by the rack system, the other being opened by a wire led from the driven panel.

Racking -

1. A distortion of the hull structure caused by a strain from a disturbed sea.
2. The deformation of the container end or side frame as a result of static and dynamic forces parallel to the deck.

Radar (radio detection and ranging) – An electronic navigation aid using radio waves sent out as a narrow beam to detect solid objects around the ship. Any solid object of a reasonable size reflects the beam and is detected on the radar screen as a bright spot. Radar systems for ship navigation operate at wavelengths of 3 and 10 cm. Two systems are usually required for larger ships, one main S-band and one auxiliary X-band. A system consists of a transmitter-modulator, receiver, a rotatable directional antenna (scanner), required power supplies, a master indicator, and remote indicators (when desired). The radar video presentation displays relative motion data in Plan Position Indicator (PPI) form on either a 12- or 16-in. cathode ray tube. The display is a map presentation of an area of 360 deg around the ship.

Radar plotting – The whole process of target detection, tracking, calculation of parameters and display of information.

Radio – A means of sending signals through space using electromagnetic waves generated by high frequency, alternating currents, i.e. 15 kHz to 100 MHz.

Radio direction finder – A radio direction-finding system on board the ship provides the means of establishing the ship position based on the location of fixed transmitting stations. Radio direction finders are used for both navigation and the safety of life at sea involving search and rescue of ships or lifeboats in distress.

Radio operator – He maintains and monitors radio, sends and receives messages. Often maintains electronic navigation equipment.

Radio Regulations – The Radio Regulations annexed to, or regarded as being annexed to, the most recent International Telecommunication Convention which is in force at any time, (**SOLAS**).

Radiobeacon – A land- or lightship-based wireless telegraph station which transmits a regular schedule of signals, from which mobile receiving stations, such as that on board the ship, may take their bearings to determine its direction in relation to the beacon.

Radiocommunication workstation – A workstation for operating and control of equipment for GMDSS distress and safety communications and general communication.

Radiographic inspection of hull welds, radiography – A nondestructive testing method which reveals internal defects in metal by exposing a film to X-rays or gamma rays passed through the metal. Radiographic inspection of hull welds is to be carried out mainly in location such as intersections of butts and seams in the sheer strakes, bilge strakes, deck stringer plates and keel plates.



Photo: J. Babicz

Radiocommunication workstation

The minimum number of checkpoints within the midship $0.6L_{BP}$ of surface vessel is to be governed by the following formula: $N = L_{BP} (B + D)/46.5$ (SI units).

The quality of welds is to be in accordance with Class A for vessels 150 m and over, or in accordance with Class B for vessels less than 150 m.

Outside the midship $0.6L_{BP}$ radiographic inspection is to be carried out at random in important locations. Quality of welds is to be in accordance with Class B.

Further reading: *ABS Guide for "Nondestructive Inspection of Hull Welds"* (2002), can be downloaded from www.eagle.org

Rail –

1. The upper rounded edge of the bulwark.
2. A pipeline, usually containing fuel, which is maintained at a particular pressure or acts as a distribution **manifold**.

Rail/vehicle ferry ARATERE

According to **Significant Ship** of 1998

Built by HJ Barreras Shipyard in Vigo, Spain, the rail freight ferry ARATERE is intended for the Cook Strait between New Zealand's North and South islands. The vessel can accommodate the largest rail-cars (up to 3m wide and 4.6m high) at any point on its tracks, and can cope with 22.5t axle loads. Rail track length is 430m.

ARATERE is designed to load and discharge rail-cars and vehicles simultaneously over the stern via fixed, shore based linkspans, but has also been fitted with a ramp on the port quarter, which provides direct access to the rail deck. Once onboard the ferry, vehicles may also be stowed in a limited space beneath the rail deck: a fixed ramp links that deck with a lower hold having capacity for 70 cars.

Rain shelters

A hydraulically operated ramp connects the train and the partially enclosed vehicle deck above. The vehicle deck provides more than 580 lane metres for trucks, with a maximum weight of 370t in passenger ferry mode and 640t in cargo ro-ro mode.

The vessel has a diesel electric power plant based on four Wärtsilä 8L32 medium speed diesel. These are linked to two pairs of ABB electric induction motors, each developing 2600kW at 1200 rev/min. Each pair of electric motors has a 5500kVA, 3.3kV frequency converter and drive twin shafts via Reintjes reduction gearboxes. The main engines and electric motors are supplemented by a single Caterpillar emergency diesel engine capable of developing 230kW at 1500 rev/min and a 225kW, 400V, 50Hz emergency generator. The machinery is complemented by two 1000kW tunnel bow thrusters. A high level of manoeuvrability has also been provided by twin Becker high-lift flap rudders, which allow propeller thrust to be directed forwards when required.

A pair of Brown Brothers fin stabilisers and an Intering air-activated heel control system are fitted to counter with notoriously bad weather conditions in the Cook Strait. The ferry is equipped with the first example of automatic mooring system IRONSAILOR. Two such devices are fitted on the port side of the ferry fore and aft. Each of them consists of a hydraulically-operated, extendible arm, at the end of which there are two vacuum pads in the form of steel rectangles (1.2mx1m) surrounded by rubber vacuum holding frames. Operated from the ship bridge, with the aid of television cameras which give a clear view along the ship sides and astern, the units are guided towards steel plates fixed to the quayside. On the contact, a vacuum is created in each suction pad which holds the vessel in place. The units are fitted approximately 2m above the waterline and are designed to resist a pull of 12.5t each.

The vessel can accommodate 355 day passengers, plus 20 drivers carried in two-berth cabins with private toilet facilities, and having their own mess and TV lounge. For the rest there is a series of lounges, a self-service cafeteria, tavern bar, cinema, TV and writing rooms, and outdoor sitting.

Length, oa: 150m, Length, bp: 137m, Breadth, mld: 20.25m, Depth to vehicle deck: 12.81m, Draught design/scantling: 5.5/6m, Deadweight: 3060dwt, Gross tonnage: 12,300, Train deck capacity: 1740t, Service speed: 19.5 knots, Crew and passengers: 400, Main engines: 4 x Wärtsilä 8L32 each rated at 3680kW at 1200 rev/min.

Rain shelters – Lightweight covers introduced for the first time on **hatchcoverless container ships** of NORASIA FRIBOURG type.

Raised quarterdeck – A superstructure which extends forward from the aft perpendicular. It generally has a height less than a normal superstructure, and has an intact front **bulkhead** (side scuttles of the non-opening type fitted with efficient deadlights and bolted manhole covers), (ICLL).

Rake – The departure from the vertical of any conspicuous line in profile such as a funnel, mast, stem contour, etc.

Rake of keel – Rake of keel is defined as the height the keel raises from the after perpendicular to the fore perpendicular.

Ram –

1. A hydraulically-operated piston which seals off a well when the blowout preventer is actuated.
2. The piston rod of a hydraulic cylinder as in a ram-type **steering gear**.

Ramform hull – The concept of the triangular-shaped hull form with an extraordinary wide stern, developed by Roar Ramde and originally adopted for Norwegian Navy surveillance ships. With an exclusive license to the design, Petroleum Geo-Services went to use it for a series of **seismic survey vessels**. The first went into service in 1995. In 1998, the 120m long RAMFORM BANFF was built by the Korean shipbuilder Hyundai Mipo.



The maximum beam, equivalent to half of its length, is at the transom, giving the vessel its shape. The broad transom allows for efficient seismic equipment handling and provides for a large working area both on the aft deck and in the instrument room. The Ramform-type hull has good motion characteristics, even in rough weather, accelerations at the stern of the ship are modest.

RAMFORM TITAN

The RAMFORM TITAN delivered by the MHI shipyard in Nagasaki, is the most powerful and efficient marine seismic acquisition vessel ever built and, with a width at the stern of 70m, the widest ship in the world at the waterline. The design couples advanced maritime technology with the imaging capabilities of the GeoStreamer seismic acquisition technology. The 70m broad stern is fully exploited with 24 streamer reels: 16 reels aligned abreast and 8 reels further forward. The 24 reels with capacity for 12km streamers give the vessel flexibility and redundancy for high capacity operations. She carries over 6000t of fuel and equipment and will typically tow a network of several hundred thousand recording sensors over an area greater than 12km².

The RAMFORM TITAN is propelled by three variable pitch propellers, each providing 6000kW of thrust. She offers a very safe work environment with a considerable degree of equipment



24-streamer Ramform Titan

Ramform Titan provides a safe and comfortable living and working environment for up to 80 crew members, with 60 single cabins, and 10 twin cabins for visitors, all with separate bathrooms.

redundancy that will enable more maintenance at sea, without interrupting operation. The ship is fully operational with just two of her three propellers, permitting maintenance during operation. Redundancy in the propulsion system extends further to dual, fully separated engine rooms. Power generation and auxiliary systems are completely separate.

Equipped with two work boats, both stern-launched, the RAMFORM TITAN can carry out acute or ongoing maintenance in marginal weather. New maritime inspection features for stern tubes and seals have extended the period between drydockings from 5 to 7.5 years.

Rapid deployment and recovery of the recording gear can increase production by several days per project and significantly extend the operational weather window. Steerable sources and streamers, and automated gear handling systems, have been augmented with added safety features, such as six independent source array handling booms, for faster equipment recovery. Dovetailing the onboard equipment with GeoStreamer technologies promises to make this the new benchmark for 3D, 4D and a variety of acquisition geometries.

Length 104.2m, Width at stern 70m, 24 streamer reels - reel capacity 12km, Fuel capacity 6000t, Bollard pull in acquisition mode 150t, Output: 1.8MW, Top speed in transit 16 knots, Crew capacity 80, Recreation suite includes 225m² ball court, fitness room, swimming pool, sauna, 3 TV lounges, auditorium.

Ramps – Large steel constructions consisting of longitudinal beams plated over to provide a vehicle roadway. External ramps are used to allow wheeled vehicles to travel between

a quay and a **ro-ro** ship; stern, side and bow ramps are used. Fixed or movable internal ramps provide access from deck to deck. For trucks and trailers, the slope angle of the shore ramps and the internal ramps between the decks must be kept below 8-9 degrees and the loading arrangement must be carefully considered. For roll trailers and cassettes, the slope angles should be less than 7 degrees.

External ramps – Usually stern ramps are used for loading and discharging of rolling cargo. Straight stern ramp, quarter ramp or slewing ramp can be used. If required, the ramp can also serve as a watertight door when pivoted or folded into its closed position.

Stern quarter ramp – Angled ramp, usually offset at an angle between 30° and 45° to the centre-line.

Slewing ramp – Stern ramp that can be set to an appropriate angle up to about 40° from the centre-line on either side.



Ro-ro vessels berthing at quays with considerable height differences require long ramps. To avoid storage problem, foldable stern ramps can be used. The foldable stern ramp/door comprises two main sections articulated together and provided with outer and inner flaps to allow smooth transition of vehicles. When in the closed position, the inner section acts as a weathertight door, secured by hydraulically-operated cleats and locking devices.

Car carriers are additionally equipped with single-piece side ramps arranged in the side shell. When raised in its closed position, the side ramp forms its own weathertight door, and there is no need for any additional inner door.



Car carrier stern ramp



Bow ramp

Bow ramps are used on ro-ro ferries to unload vehicles. The bow ramp is usually an axial ramp linking the ship to the quay through a bow opening having a visor or side-hinged **bow door**.

Internal ramps – Fixed or hinged internal ramps are used for distribution of cars, trailers or cassettes within the ship. Hydraulically-operated steel covers are installed over fixed internal ramps. The ramp covers fulfil the same requirements for load carrying capacity and watertightness as the surrounding fixed deck. Depending on needs they can be either side-hinged or end-hinged.

Spiral ramp – A special ramp on the forecastle deck constructed for the first time by Gdansk Shipyard.

Tiltable ramp – The single-section internal ramp provided with flaps and hydraulically-disconnected hinges at both ends. In this arrangement, the hinge at either its forward or after end can be secured to the upper of the two decks, allowing the opposite end to be lowered to the other deck. Raising/lowering is accomplished by a pulling cylinder/wire system.



Rapson's slide – A crosshead arrangement used on ram-type **steering gear** in which the mechanical advantage increases with the angle of turn. It is used to convert the straight line motion of the rams into an angular movement of the tiller.

Raster navigational chart (RNC) – Raster scan chart is a scanned reproduction of a paper chart. It is a computer-based system which uses charts issued by, or under authority of, national hydrographic offices, together with automatic continuous electronic positioning to provide an integrated navigational tool.

Using vector and raster charts alongside each other requires hardware that can process and display both categories.

Rated speed of engine

Rated speed of engine – The crankshaft revolutions per minute at which the **rated power** occurs as specified on the nameplate and in the **Technical File** of the marine diesel engine.

Receiving point – A mark or place at which a vessel comes under obligatory entry, transit, or escort procedure.

Reciprocate – An alternating motion between two extreme points on a fixed path, e.g. up and down motion.

Recognized Security Organization (RSO) – An organization with appropriate expertise in security and anti-terrorism matters recognized by the Administration and authorized by it to carry out assessment, verification, approval and certification activities, required by SOLAS Chapter XI-2 or by Part A of the ISPS Code, on its behalf.

Record book of engine parameters – The document for recording all parameters changes, including components and engine settings, which may influence **NOx emission** of the engine.

Rectifier – A circuit which converts single or three-phase alternating current to direct current (AC to DC).

Reducing valve – A valve which is designed to maintain a lower constant fluid pressure at outlet, regardless of the inlet conditions.

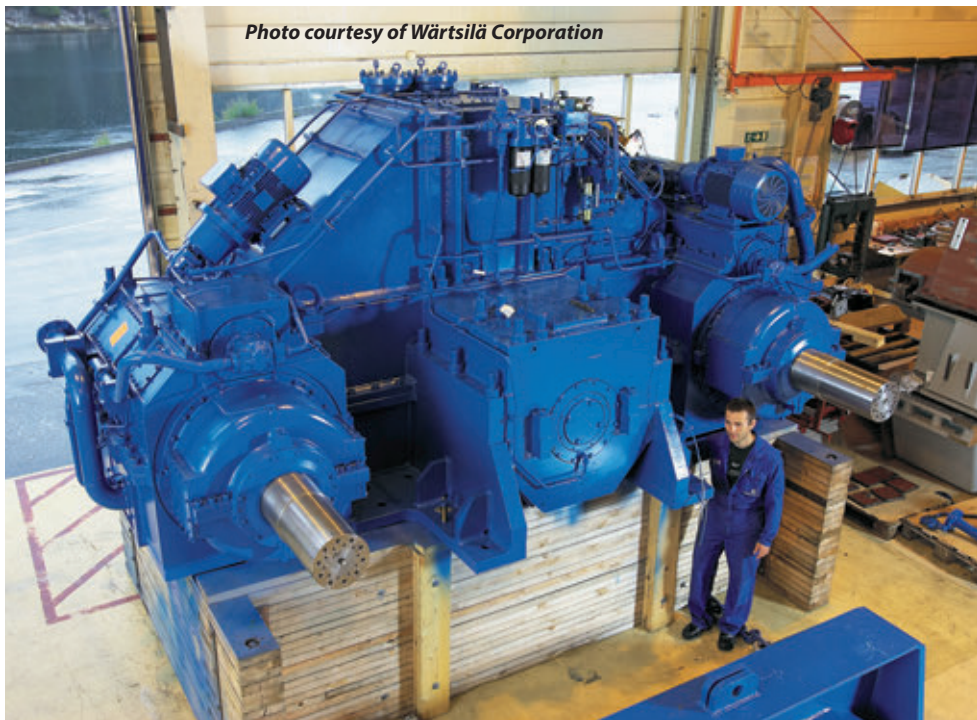

Twin in - single out

Reduction gear, gearbox – Equipment used to convert the output shaft revolutions of the main engine to those required to rotate the **propeller**. Gearboxes consist of meshing teeth on pinions and wheels which transfer power from a drive shaft to a driven shaft and reduce speed.

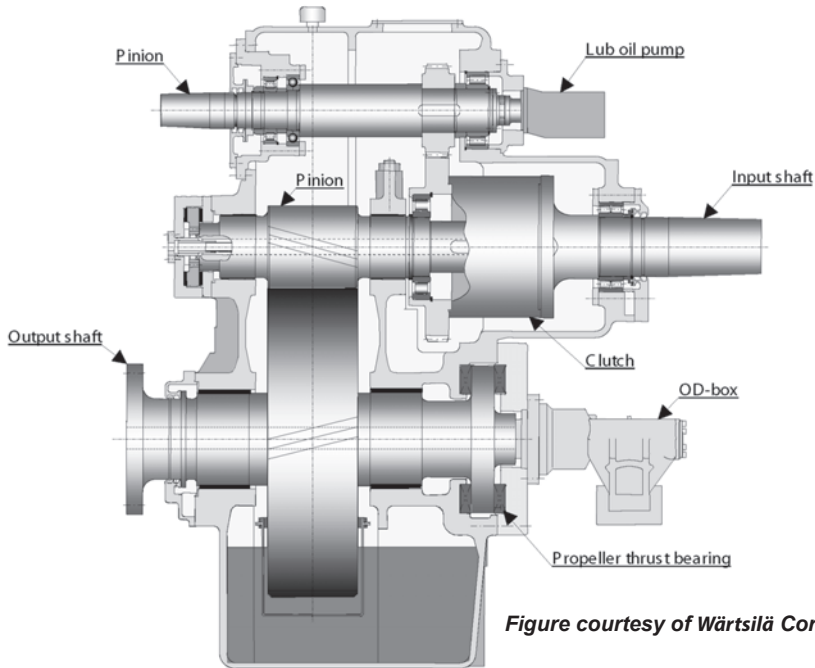

Figure courtesy of Wärtsilä Corporation

Cross-section of the single stage single input gear with clutch and primary PTO

Redundancy – The provision of equipment or components which are surplus to operational requirements in order to continue operation after a failure. Redundancy can be achieved by installation of multiple components, systems or alternative means of performing the same function.

Level of redundancy – The classification of mechanical, electrical and spatial separation and also the independence of the systems required for propulsion and steering. The redundant propulsion power of the propulsion system is denoted by the additional index x%. Example: The additional index 40 % means that following a failure of one of the redundant propulsion systems, at least 40 % of the main propulsion power will still be available.

Redundancy of propulsion – Duplication of various machinery and systems forming a part of the propulsion system. Redundant propulsion plants for hazardous cargo ships can be achieved by doubling the main **engines, propellers** and **rudders**.

Redwood seconds – A unit of measurement of kinematic viscosity when a Redwood **viscosimeter** is used. Standard temperatures of 21°C for lubricating oil and 37°C for fuel oils are used.

Reefer/container vessel CARMEL ECOFRESH

According to **Significant Ships** of 2003

The hybrid reefer/container vessel CARMEL ECOFRESH, built by the Portuguese shipyard Estaleiros Navais de Viana do Castelo, is fitted with the first Wärtsilä Sulzer RT-flex60C main engine. The seven-cylinder model has an output of 16,520kw at 114rev/min. The steady running of this engine can be achieved at exceptionally low speeds; 10%-12% of nominal rotational speed, and smoke-free operation is another important feature.

Reefer vessel

The vessel is intended for operation between Haifa, Marseilles and Barcelona offering some 460,000ft³ of refrigerated space on the westbound voyage, and capacity for nearly 700 cars and 900TEU on the backhaul run.



An interesting feature is the adoption of an innovative arrangement with the **superstructure** located amidships above the large, fully-insulated refrigerated hold. Three conventional cellular holds are placed forward of this hold and two aft, offering places for 266TEU. Additional 630TEU can be carried on hatch covers and open deck provided with **lashing bridges**.

The refrigerated hold is divided by six cargo decks, constructed of lightweight sandwich panels, into 18 compartments. No vertical access is provided to these spaces. Loading of palletised cargo and vehicles is accomplished by means of a Macor Neptun side-loader with a vertically sliding door giving access to deck N°3 starboard side. Internal distribution is carried out by a twin Hortal conveyor-lift system. Cargo can be handled at a rate of roughly 275 pallets/h or 500 cars in 8h.

Hold temperatures can be maintained between -30°C and $+13^{\circ}\text{C}$, using a GEA-Grenco plant with three chiller units working on the indirect system. R407C is the primary refrigerant, and calcium chloride brine serves as the secondary heat transfer fluid. Cooling of cargo spaces is effected by a transverse flow, grating-less, recirculating air system. A mechanical ventilation system provides the refrigerated hold with 4 air changes/hour when carrying reefer cargo, and 10 air changes/hour when loaded with cars.

Length, oa: 185.50m, Length, bp: 174.53m, Breadth, mld: 24.14m, Depth to main deck: 16.40m, Design draught: 9.30m, Deadweight: 16,494dwt, Lightweight: 10,077 tonnes, Service speed: 21.00 knots, Refrigerated cargo capacity: 465,000ft³ (4221 pallets), Main engine: 1x Wärtsilä 7RT-flex-C, MCR: 16,520kW.

Reefer vessel, refrigerated cargo ship – A vessel designed to carry goods requiring specific climatic conditions during transport, such as meat, fruit and fish. A reefer ship has special insulated holds into which cold air is forced at the temperature appropriate for the goods being carried.

Reefer vessel LOMBOK STRAIT

According to **Significant Ships** of 2002

In August 2002, Seatrade Groningen took delivery of the innovative reefer vessel LOMBOK STRAIT built by CSBC Taiwan. The ship principal feature is the new pallet-handling system supplied by TTS in order to improve the efficiency of refrigerated cargo handling under all weather conditions.

The system operates through two large deckhouses positioned on the upper deck. Each is fitted with a pair of topside hatches which can be worked by one of the two TTS-Norlift 45t SWL deck cranes. Side doors in the houses hinge outward and upward to provide cargo access and at the same time give weather protection to the handling operation, with assistance from side curtains. They also support the extending rail and trolley which form the basis of the system.

Cargo is loaded into the ship using pallet-cages containing cartoons which are hoisted by automated trolleys radio-controlled by one man. Within the vessel, the distribution is by forklift truck. A feature of the system is the ability to programme starting/stopping points for loading and discharging.

The vessel has four cargo holds arranged in eight independently insulated, gastight temperature zones. Cargo capacity of 17,727m³ is equivalent to 5600 standard fruit pallets. The ship also has 440TEU container slots and 200 reefer plugs on deck.

The LOMBOK STRAIT has a brine reefer plant which controls the hold temperature in a range from -25°C to +15°C. The atmosphere in the holds is controlled by a nitrogen gas plant which can generate about 1000 Nm³/h/95%N₂. A similar plant for modifying the atmosphere in the containers generates about 190 Nm³/h/95%N₂.

Length, oa: 167.00m, Length, bp: 157.00m, Breadth, mld: 25.00m, Depth to main deck: 13.40m, Draught design/scantling: 8.70/9.30m, Deadweight: 13,600dwt, Lightweight: 8300 t, Trial speed: 23 knots, Refrigerated cargo capacity (bale): 17,730m³, Main engine output: 15,801kW at 105 rev/min.

REFCON system – The monitoring and alarm system, which registers complete history of individual reefer containers, recording all important parameters and storing the data in a log file. REFCON uses the reefer container's own power cable to transmit data between the container and the computer monitoring system on the vessel or in a container terminal. The standard system can monitor containers fitted with WideBand modems and containers fitted with NarrowBand Modems. Optionally it can monitor conventional reefer containers fitted with 4-Pole monitoring socket.

Reference line – A virtual line displayed on the radar screen separating the fairway for inbound and outbound vessels so that they can safely pass each other.

Refit – A complete maintenance and refurbishing process usually requiring the equipment overhaul and repair, cleaning and painting. Improvements and modifications are usually undertaken to modernize or up-date fixtures and fittings in, for example, the refit of a ship.

Refractory – A material, usually in brick form, which is used to line boiler furnaces. It must resist high temperatures, change in temperature and the effects of hot flowing gases. Suitable materials include china clay, fire clay and silica.

Refrigerant – A fluid employed as the heat absorber or cooling agent in any refrigerating process. A refrigerant can be easily changed from a liquid state to a vapour state and back to a liquid state.

Refrigerated container

The main refrigerant used in marine installations has been R12, however as this chloro-fluorocarbon refrigerant damages the ozone layer, there is a move towards more ecological products, notably R134A or ammonia used in many early refrigerating plants.

R-22 is an HCFC refrigerant gas and, despite being scheduled for worldwide phase-out in 2030, remains to be the most commonly used refrigerant today. Under the Annex VI of MARPOL, anyone deliberately venting R-22 into the environment risks being fined by Port State authorities. Each vessel must be fitted with equipment to properly recover CFC and HCFC refrigerants and, when necessary, dispose them of in the prescribed manner. Refrigerants must be isolated or recovered during maintenance, conversion and scrapping of a refrigeration system. All ships sailing across American and Canadian waters must carry empty recovery cylinders on board to store refrigerants in case of repair, and the crew must be fairly-familiar with their use.

Refrigerated container, reefer box – An insulated shipping container designed to carry cargoes requiring temperature control. It is fitted with a refrigeration unit which is connected to the ship electrical supply. See also **REFCON system**.

Refrigerated fish carriers – Fish processing vessels, fishing vessels, and mother ships of fishing fleet which are provided with facilities for freezing fish and their products.

Refrigerated storage spaces – Spaces designed for the storage of perishable cargo. Refrigerated cargo spaces are intended to transport perishable cargo while refrigerated stores are intended to preserve perishable foods for shipboard use.

Refrigeration – A process in which the temperature of a space or its contents is reduced to below the one of their surroundings. The compression cycle of refrigeration is the most common procedure. In this type of a cycle, a **refrigerant** vapour is compressed and gains energy corresponding to the work of compression. The hot, compressed vapour is then cooled by water or atmospheric air. This cooling process condenses the hot vapour to a liquid. The high-pressure liquid is expanded to a lower pressure and becomes a cold mixture of liquid and vapour. This refrigerant mixture is fed into an evaporator where it absorbs heat and changes back to vapour, the same state as at the beginning of the compression cycle.

The principal components of the compression refrigeration system include a receiver for storing liquid refrigerant, an expansion valve for controlling the flow of refrigerant, an **evaporator** where the required useful refrigeration is produced, a **compressor** that maintains the evaporator suction pressure and increases the refrigerant vapour temperature and pressure, and a **condenser** that cools and condenses the hot refrigerant vapour to its original liquid state.

Cargo refrigeration – In **reefer ships**, the refrigeration systems are used for the preservation of perishables such as fruits, vegetables, flowers, and meat to ensure their transfer to distant markets. The cargo space is usually divided into several compartments. The size of the compartments and the conditions in them (temperature, humidity, etc.) vary according to the cargoes carried and their compatibility with respect to odours, method of packing, susceptibility to damage, etc. The cargo may be frozen, requiring a storage temperature as low as –20 F, or chilled, with a storage temperature as high as 55 F. For flexibility, the storage spaces are usually designed to be convertible from frozen cargo to chilled cargo and vice versa.

Refrigeration machinery spaces – Spaces dedicated for housing refrigerating machinery and the associated equipment.

Refrigeration unit – The machinery comprising the **compressor** with a driving motor, and a **condenser**, if fitted, independent of any other refrigeration machinery for provision stores or the air conditioning plant. In indirect refrigeration systems, the refrigeration unit also includes a brine or other secondary coolant cooler.

Refrigeration system – One or more **refrigeration units**, together with the piping and ducting system as well as the equipment necessary for cooling and maintaining it at the required temperature.

Relative density of liquid – The ratio of the mass of a product volume to the mass of the equal volume of fresh water. For a product of limited solubility, the relative density indicates whether it floats on water or sinks, IBC Code).

Relative humidity – The amount of water in the air compared to the maximum amount it can absorb at that temperature. Relative humidity expresses the relationship between the water content of the air at a stated temperature and the water content of saturated air at the same temperature.

Reliability – The ability of a component, a machine or a system, to perform a particular function under stated conditions for a particular period of time.

Relief valve – A **valve** which opens automatically to release excess pressure from a pipeline or a containment vessel, e.g. safety valve on a boiler drum.

Remotely-operated vehicle (ROV) – Tethered underwater robot. ROVs are common in deepwater industries. They became essential in the 1980s when the depth of many offshore projects excluded the use of divers. ROVs now carry an extensive range of measurement and monitoring instruments in addition to the tools, lights and cameras required to perform a wide variety of underwater tasks. These range from the routine inspection of subsea structures, pipelines and platforms to connecting pipelines and positioning underwater components.

Buoyancy is provided by a large flotation pack located at the top of a rigid steel or alloy chassis. Heavy items of equipment are placed near the bottom of the vehicle, cameras, lights and manipulators are located at the front.

Thrusters are provided in all three axes to maximize manoeuvrability, and electrical cables are often run inside oil-filled tubes to avoid corrosion. The construction of Work Class ROVs is generally heavier than Observation Class (eyeball) ROVs, and they can often operate at greater depths.

Remotely-operated vehicle Sealion 3000

The Sealion 3000 is a deepwater work class, 100hp ROV capable of operating in depths to 3000 metres. Features include two, seven-function manipulators and vectored **thrusters** which use a four-bladed propeller to give greater power. A fibre optic telemetry link provides high reliability communications between the Sealion and its surface control and a super VHS video facility when working at extreme depths. The Sealion has a through frame lift of 5t and can be fitted with an optional top hat or cage-deployed tether management system.

Vehicles are capable of a wide range of work tasks and are particularly suited for valve operation, well head cuttings removal, operation of disc grinders, bathymetric surveys, sub bottom pipe tracking and video observation as well as a wide variety of other subsea construction and survey tasks which take advantage of the Sealion's power and adaptability.

For more information visit www.thales-geosolutions.com

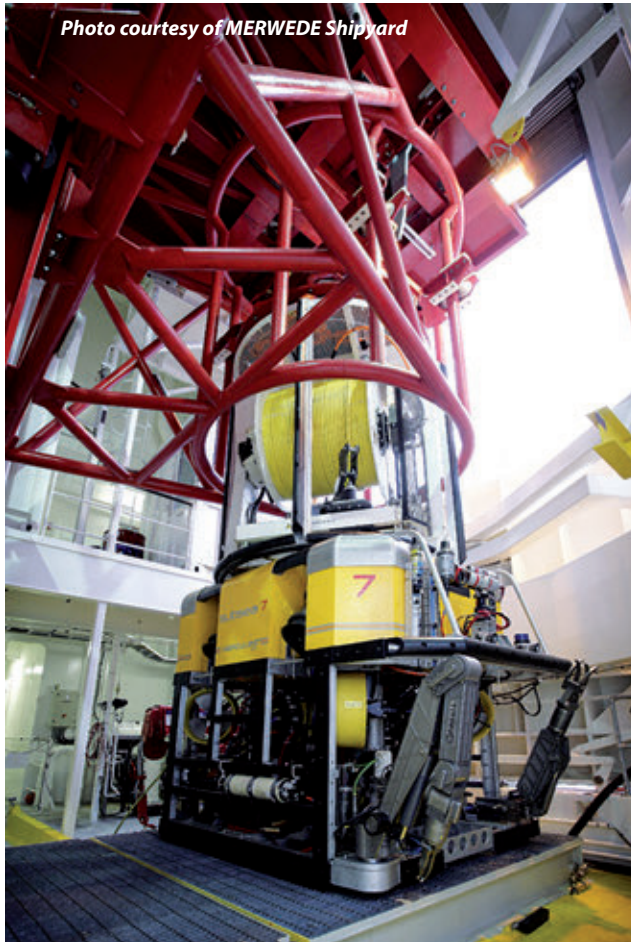

Photo courtesy of MERWEDE Shipyard

ROV on board SEVEN OCEANS

Removable tweendeck – Multi-purpose vessels are often equipped with a removable tweendeck: a set of steel lift away pontoons which can be fitted within the hold at different heights above tank top. Additionally, the pontoons can be positioned vertically and used as grain bulkheads or cargo divisions. Permissible loads 3.5 – 5t/m².

The multipurpose vessel MAKIRI GREEN has two holds equipped with set of loose tweendeck pontoons adjustable in three heights. Uniform load 4t/m², weight 420t, total surface 1616m², (260kg/m²).

Rendez-vous – An appointment between vessels normally made by radio to have a meeting in a certain area or position.

Required free-fall height – The greatest distance measured from the still water surface to the lowest point on the lifeboat when the lifeboat is in the launch configuration and the ship is in its lightest seagoing condition. See also **Free-fall certification height**.

The required free-fall height shall never exceed the free-fall certification height.

Representative spaces – Those spaces which are expected to reflect the condition of other spaces of similar type and service and with similar corrosion prevention systems.

RESCUBE evacuation system – A novel idea of evacuation of a large number of people from a passenger vessel, proposed by Jan Ingar Norheim and developed by Norsafe.

A large free-fall craft (Rescube) with three compartments, containing 110 persons each is key element of this system. The Rescube will be installed vertically in a slot in the shipside or vertically on the aft end of the vessel. People will enter the Rescube from six levels. After closing, the Rescube will be released and it moves to free-fall position. Then, the Rescube will drop into the sea as an ordinary free-fall lifeboat.

Note: The detailed description and pictures can be found on www.norsafe.no

Rescue boat, also Man Over Board (MOB) boat – A davit-launched, motor-propelled light boat provided to perform man-overboard retrieval and raft marshalling duties. The boat may be of either rigid or inflated construction or a combination of both. Usually, it is a semi-rigid structure with the inflated chambers of an upper sponson and an outboard engine. Safe launch and recovery is still the major problem facing the use of rescue boats and little or no onboard training is carried out other than in calm conditions.

In accordance with current **IMO** regulations:

1. Passenger ships of 500 gross tonnage and over shall carry at least one rescue boat on each side of the ship,
2. Passenger ships of less than 500 gross tonnage shall carry at least one rescue boat,
3. At least one of rescue boats on a **ro-ro passenger** ship shall be a fast rescue boat with a minimum length of 6m and a top speed of at least 20 knots (MSC/Cir.809).
4. Cargo ships shall carry at least one rescue boat.

In most cases ships are provided with small, slow and cheap versions of rescue boats. Such practice can be justified in case of smaller ships where it is quite difficult to find good place for stowage. Contrary, a large tanker could be provided with a large rescue boat. Despite of plenty space available, the small inflated rescue boats can be found even on board very large crude carriers.

The rescue boat is boarded and launched directly from the stowed position with the assigned crew. According to **SOLAS** rescue boats shall be stowed:

1. In state of continuous readiness for launching in not more than 5min, and, if inflated type, in a fully inflated condition at all times.
2. In position suitable for launching and recovery.
3. So that neither the rescue boat nor its stowage arrangement will interfere with the operation of any survival craft at any other launching station.

The rescue boat embarkation and launching arrangements shall be such that the rescue boat can be boarded and launched in the shortest possible time. In addition, rescue boat embarkation and recovery arrangements shall allow for safe and efficient handling of a stretcher case.

On board large container vessels the accommodation is located at three-quarter. Very often these ships are provided with two classic lifeboats one of them equipped as rescue boat. Despite of plenty of space available the same solution is often adopted for car carriers. As a result, many large vessels have no additional rescue boat at all. Totally enclosed lifeboat should not be used as rescue boat due to limitations in visibility, manoeuvrability and recovery of persons from the water.



Right arrangement of rescue boat, far away from the propeller, high enough to be protected from damage by heavy seas

Dock-launched fast rescue boat – A patented concept employing a floating dock arrangement that enables a fast rescue boat to be safely launched in severe weather conditions developed by Marine Safety Systems for **ro-ro** passenger ships.

When stowed on board, the rescue boat is secured in the dock by a locking system. When required, the dock with the boat is launched by conventional davits or crane. When the dock is floating, the boat locks are released and the boat leaves the dock under its own power. For retrieval, the boat enters the dock, is secured into position, and the two are hoisted back on board.

Rescue boat davits – Usually hydraulic operated slewing or pivoting davits designed for launching and recovery of a fully-manned **rescue boat** against unfavourable conditions of trim of up to 10 degrees and a list of up to 20 degrees either way.

Slewing out of the rescue boat from its stowed position into launch position is performed by means of accumulated power obtained from a hydraulic power pack. The slewing motion is actuated within the rescue boat by means of a remote control pull wire.

Lowering is done by means of gravity. The lowering motion can be controlled in two ways: either by a remote control pull wire within the rescue boat or by lifting the brake handle of the winch directly. The recovery of the fully-manned rescue boat is accomplished by the electric winch. In case of a power failure or malfunction of the electric system, hoisting can also be done manually by the crank handle of the winch.

Note: *Drawings, data sheets and technical specifications of hydraulic slewing and pivoting davits can be found on www.neddeckmarine.com*

Rescue co-ordination centre (RCC) – Land-based authority conducting and co-ordinating search and rescue operations in a designated area.

Rescue team – A group of crewmembers standing by in case of emergency in order to assist other teams in action if necessary.

Research ships – Specialized ships engaged in oceanographic research, marine exploration, offshore exploration and survey, fisheries and biological research, hydrography, mineral survey and meteorological observations. Deck machinery supporting the scientific mission consists of cranes, trawling/coring winches and special overside-handling equipment.

See also **Fishery research vessel G.O. SARS**, **Fishery research vessel CELTIC EXPLORER**, **Oceanographic research vessel RRS JAMES COOK**.

Reserve buoyancy – Enclosed spaces, which provide **buoyancy** in addition to that required by a vessel to float. It is always considered in the assignment of freeboard to a ship.

Residual stability – The positive range of the righting lever curve after damage, with external heeling levers taken into account.

Resilient mountings – Machine supports which utilize springs or an elastomeric material to prevent the transmission of vibration to the supporting structure.

Resin – A hard, brittle substance insoluble in water.

Epoxy resin – Liquids which can be poured and cured at room temperatures. The cured material is tough, solid, durable and unaffected by oils and seawater. It may be used as a chocking material for engines, for adhesives or as a surface coating e.g. paint, because of its good adhesion.

Resonance thickness measurement (RTM) – A new thickness-measuring technique introduced by **Det Norske Veritas**. RTM sensor emits a spectrum of resonated sound waves which pass through the corroded steel. A reflected signal is interpreted to give an accurate measurement of its thickness. The typical accuracy is within 0.1 mm on heavily-corroded plating. Corrosion products and marine growth do not effect readings. When this new tool is mounted on a remote-operated vehicle, it allows for rapid scanning of the entire hull plating below the waterline. See also **Wet surface hull scanner**.

Restricted area – A deck, space, area, etc., not permitted to be entered for safety reasons.

Restricted visibility – Any condition in which visibility is restricted by fog, mist, falling snow, heavy rainstorms, sandstorms or any other similar causes, (COLREG).

Retarded injection timing, late injection – Retarded start of injection is a commonly used primary method for effective NO_x emission reduction in the **diesel engines** and has negligible effect on fuel consumption when keeping injection duration conveniently short. See also **Low NO_x combustion**.

Reverse current protection – A **relay** fitted between a generator and the **switchboard** which will trip and disconnect the main circuit breaker in the event of a reverse current flow.

Ride control system – A stabiliser system designed to reduce the craft wave-induced motions. Fast ferries operating in rough water require ride control systems to ensure passenger comfort.

Rig move – The movement of an oil rig, drilling platform, etc., from one position to another.

Rigging – Ropes, wire ropes, lashings, masts, booms, etc.

Righting arm GZ – When the ship floating at rest in still water is inclined by an external force to a small angle ϕ , the centre of gravity G will remain in the same position but the centre of buoyancy moves towards the submerged side, to the new position B ϕ . This creates a moment $WxGZ$ known as the righting moment. GZ is known as the righting arm.

The plot of the righting arm GZ calculated as the function of the heel angle, at constant displacement and vertical centre of gravity KG values, is used to measure the ship stability at large angles of heels. It is called the curve of statical stability.

Rigid pipelaying vessel SEVEN OCEANS

According to **HSB International** June 2007

Built at the Merwede Shipyard in Netherlands, the SEVEN OCEANS is intended for installation of rigid pipes up to a diameter of 16" on the ocean floor in depths up to 3000m using the reel-lay method. It is the fastest method for installing oil pipelines on the seabed: because the lengths of pipeline are already welded together on shore, the vessel can continue to sail while the pipelaying is in progress. With an installing speed of 35 metres per minute, 100 kilometres of steel can be installed on the seabed in just two days. The ship can deploy two remote operated vehicles which can monitor the pipelaying activities. Besides pure pipelaying, the ship can be used for subsea construction, ROV support and survey activities.

Centrally in the ship, there is a large reel for the storage of the rigid pipe. In a typical loading scenario, the ship will anchor herself with her stern facing the shore. The pipe can then be reeled-in from a production facility on shore, almost eliminating the need to weld or coat pipes in the difficult conditions of-shore.

The pipelaying activities are mostly concentrated on a 47.5m-high tower on the aft deck called the "lay ramp". At the top of the tower there is an 18m diameter wheel, called the "aligner wheel". Just below the wheel is the "straightener". This device is composed of four caterpillar tracks which straighten the pipe. Below the straightener there is the so-called "Solex-drive" which can move the pipe up and down along the aft tower. Finally, the tensioner can provide a pull onto the pipe of up to 400t. This is necessary to compensate the force of the rigid pipe on the reel and to pull the pipe off the reel. The entire tower can be tilted forward from the vertical position through 45 degrees. The angle is adjusted to the water depth and the characteristics of the pipe to be laid.

The ramp can also be moved 5m either side of the vessel's centreline, to port or starboard, to minimise the fleeting angle between the ramp and the main reel. The entire assembly of the tower is mounted on a skid frame, which in turn is mounted on a pair of very heavily constructed transverse skid beams.

The SEVEN OCEAN is equipped with two ROVs stored in a large hangar at the aft side of the superstructure. Each ROV fits into a protective basket, which can be brought to the ship's side through an overhead beam crane. The basket can then be lowered into the water along tracks on the ship's side, acting as an "outboard elevator". This way the ROV is brought through the "splash zone" in a controlled manner, after which the ROV can be manoeuvred out of its basket.

The vessel can also be used to install large subsea manifolds on the ocean floor. The main crane onboard is located on the portside and has a SWL of 400t at 16.5m. It is equipped with a heave compensator. A smaller knuckle boom crane on starboard has a SWL of 40t, while another one mounted to the aft deck tower can lift 12t at a distance of 25m.



Photos courtesy of Merwede Shipyard

Pipelaying/offshore construction vessel SEVEN OCEANS built by Merwede Shipyard in 2007



The 28-meter diameter reel weighs more than 900t, making it the largest reel which has ever been made. The quantity of steel which can be transported on the reel – 3500t – is also a new record

REELED RIGID PIPELAYING / OFFSHORE CONSTRUCTION VESSEL

$L_{OA} = 157.30\text{m}$, $L_{BP} = 138.32\text{m}$, $B = 28.40\text{m}$, $D = 12.50\text{m}$

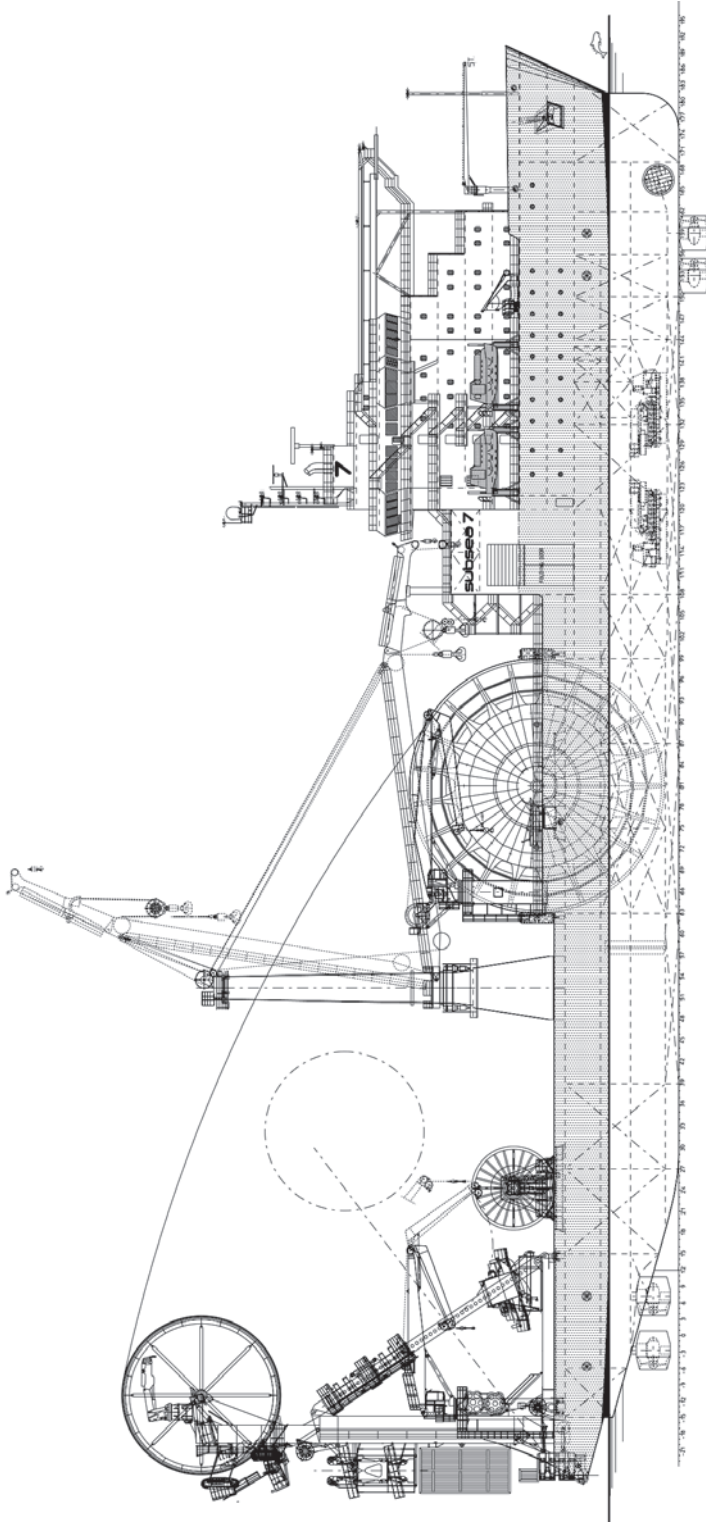

Drawing courtesy of Merwede Shipyard

A diesel-electric propulsion and energy arrangement is fitted, contained in two separate engine rooms, three propulsion, and two switchboard rooms. This is centred upon six Wärtsilä generating sets with 7L32 main engines driving 3600kVA alternators. These power three 2950kW azimuthing thrusters aft, two 2400kW retractable azimuthing thrusters and one 2200kW tunnel thrusters forward, plus the pipelaying equipment and shipboard facilities. The thrusters are all FP type, supplied by Wärtsilä Lips.

Length, oa: 157.31, Length, bp: 138.22m, Beam, mld: 28.4m, Depth, mld to the main deck: 12.5m, Design draught: 7.5m, Deadweight, design: 11,134dwt, Output: 20,160kW, Main propulsors: 2x2950kW azimuthing thrusters + 2x2400kW retractable bow thrusters, Trial speed with three thrusters: 14.5 knots.

Rim-Driven Permanent Magnet Motor Propulsor (RDP) – A new type of drive developed by General Dynamics Electric Boat of Groton, USA. This drive is more compact and has several features that differ significantly from other pods available today. The motor of the conventional pods is encased within a **pod** (hence the name) on the same shaft as the propeller. The concept of the RDP is entirely different. Basically it consists of a **propeller** rotating within a nozzle, which has an integrated downstream stator. The rotor shaft and bearing system are supported in the stator hub. The electric motor is integrated onto the rotor rim and the entire motor is embedded in the **nozzle**. The nozzle is attached via struts to the slewing bearing in the hull.

Rise of floor – The distance above the keel that a tangent to the bottom at or near the keel cuts the line of maximum beam **amidships**.

Riser – A conducting pipe connecting sub-sea wellheads, templates or pipelines to the equipment located on a buoyant or fixed offshore structure, (ABS).

Example: A large-diameter pipe that connects the drill floor of a floating rig to the **wellhead**. The drill string and drilling tools pass through it and mud is returning to the rig.

River/sea vessel, river/sea trader – A low-profile vessel designed for navigation in coastal waters and river/sea trading. As a consequence, a river/sea vessel features a shallow draught in loaded condition as well as low overhead clearance in ballast condition. This type of vessel is often provided with a **wheelhouse** adjustable in height, which can be fixed in two positions. A typical river/sea vessel, suitable for West European inland waterways, has a length limited to 85.00m and a maximum beam of 11.40m.

The THARSIS is a typical low-profile coaster of 2000 tonnes of cargo carrying capacity with a box-shaped hold. The river/sea vessel features a shallow load draught of about 3.40m, and a ballast draught of 2.80m in combination with an air draught (overhead clearance) of not more than 4.50m. The wheelhouse is adjustable in height with a maximum height of 4m from the lowest position.

Road tank-vehicle – A vehicle on wheels fitted with a tank or tanks intended for transport of gases, liquids or solids by both road and sea modes of transport. The tank or tanks are rigidly and permanently attached to the vehicle during all normal operations of loading, transport and discharge and are neither filled nor emptied on board.

Road vehicle – A commercial vehicle, semi-trailer, road train, articulated road train or a combination of vehicles, as defined in Assembly resolution A.581(14).

Rock damping – Deposition of rocks onto subsea pipelines to provide protection against anchors and fisherman nets when burying pipes is impractical.

Roll call – The act of checking the presence of the passengers and crewmembers, e.g. at assembly stations, by reading aloud a list of their names.

Roll reduction – The difference between unstabilised and stabilised roll angles at resonance in regular sinusoidal beam seas with a specified maximum waveslope and at a specified ship roll damping ratio.

Roll stabilisation – A variety of roll stabilisation systems are available to reduce ship motions and forces which can cause cargo damage, undermine passenger comfort and crew efficiency, and increase resistance. Among the main options are **bilge keels**, passive tanks, activated fins and rudder stabilisation, and combinations of these systems.

Bilge keels are a simple measure used against rolling. They act in two ways. First, a hydrodynamic force opposed to the roll motion develops on them. Secondly, bilge keels cause vortices that increase the viscous damping of the roll motion. The most common way of stabilising vessels that normally operate at cruising speeds of 12 knots or more has been the use of **active-fin stabilisers**. For vessels which operate at speeds too low for active-fin stabilizers, **anti-roll tanks** or flume stabilisation systems are often used.

Cruise ships can benefit from combined stabilising systems with fin stabilisers deployed primarily at speed while tank stabilisers assume responsibility for roll reduction under other operating conditions. Movable-weight systems are the alternative means of reducing roll amplitudes. See also **Rudder roll stabilisation**.

For more information visit www.intering.com

Rolling cargo, wheeled cargo – Cargo on wheels, such as trucks, trailers or diverse rolling general freight and which can be driven or towed onto a ship.

Roll-on/roll-off system – The modern cargo handling technique first introduced in 1950s.

Cargo is literally rolled on board **ro-ro** ships. Rolling stock is ready for delivery upon arrival at the discharge port, and loading, stowing, and discharge operations are simplified. This method is used on board many ships such as ro-ro freight ferries, **multipurpose ro-ro carriers**, **car carriers**, **rail/vehicle ferries** and car/passenger ferries.

Ro-lo vessel – A hybrid vessel equipped with hatch covers and cargo access facilities characteristic for **ro-ro vessels**.

Ro-lo forest product carriers from Gdynia Shipyard

The main feature of the three ro-lo vessels delivered by Gdynia Shipyard is multi-access system designed by MacGREGOR. The system includes stern ramp/door, side loading outfit



*Designed and built by Gdynia Shipyard
Photo courtesy of MacGREGOR*

and folding **hatch covers**. Although purpose-built for forest products, the vessels are also configured to carry containers, rolling and bulk cargoes.

Rolling freight

Stern access for rolling freight to the tweendeck level is arranged over an 18m long ramp/door with a driveway of 12m into a 6.4m high opening. Access into the aft part of the tweendeck is via a top-hinged **bulkhead** door which is hydraulically raised to offer a clear opening 21m wide and 6.4m high. The forward end of the tweendeck is served by side-hinged bulkhead door comprising two sections, which are hydraulically actuated to yield a clear opening 16.4m wide and 6.2m high.

Side-loading system

The side-loading system installed on the starboard side serves tanktop and tweendeck levels. Its **watertight door** (15.2m wide x 16.0m high) encloses three loading platforms arranged with three 16-tonne capacity conveyors. In the deployed mode, the platforms are pivoted outboard over the quay. Guiding rails on the hull allow their position to be adjusted to the quay height.



The cargo elevators connected to the loading platforms are designed to handle a paper reel load up to 16 tonnes with a maximum lifting speed of around 27m/min.

Folding hatch covers

High-stowing folding hatch covers are specified for the weatherdeck. Nos 1 and 2 holds are each served by four-panel end stowing Foldtite sets. No 4 hold is equipped with a single panel-pair folding set. High-stowing folding covers are also installed in No 2 tweendeck. The set is designed to accept a uniformly distributed load of 8 tonnes/m² and diverse vehicle loads from Mafi wagons, forklift trucks and Rolux cassettes.

Rolux wheelless cassette system – The cargo handling system developed in Finland. It is focused on a 60-tonne capacity flat panel (12.2m x 2.6m) for loading cargo which is supported by four “legs” 850mm from the ground. All kinds of cargoes, including containers, forest products, and particularly paper reels can be loaded. The container locks, lashing points, stanchion and forklift pockets, also stacking locks are all built in.

The second part of the system, the Rolux trailer for cassette movement, is hauled by any port tractor unit. This goose-necked trailer is backed under a cassette when hydraulic power is applied to lift it off the deck or ground. The cassette can then be moved. The trailer can additionally be used to lift cargoes stored on trestles.

Ropax, Ro-pax, RoPax – A vessel with large **ro-ro** decks and limited passenger facilities. Usually, the **superstructure** covers part of the upper deck. The vessel design normally allows for drive-through traffic, i.e. loading aft and unloading forward, or vice versa. The internal distribution of vehicles can be accomplished through deployment of internal ramps or loading on two levels by two-level shore ramps. For flexibility, RoPax vessels are usually equipped with hoistable car decks.

RoPax NILS HOLGERSSON

According to MacGREGOR Press Release 28 March 2001

NILS HOLGERSSON and PETER PAN are 34,000gt RoPax ferries built by the Bremerhaven yard SSW Fahr-und Spezialschiffbau for Hamburg-based operator TT-Line. The ferries are deployed on the Travemünde (Germany) – Trelleborg (Sweden) route, offering some 2640m lane capacity for trucks over three decks.

The bow, stern and side access for rolling freight with internal transfer between main, lower and upper vehicle decks is secured by **ro-ro** system packages from MacGREGOR. The RoRo Ship Division supply also includes: pilot, bunker and passenger doors; a provisions container hatch; a scissors lift for the engine stores; a hatch cover for the scissors lift and four hydraulic power packs.

MacGREGOR RoRo package includes:

- bow door operating equipment
- bow ramp/door with disconnectable ramp
- stern ramp/door serving the main vehicle deck
- stern ramp serving the upper vehicle deck
- tiltable ramp
- two side ramp/doors
- two ramp covers
- hoistable ramp.

Forming a weathertight part of the forebody structure, the bow door is divided into two sections with an intermediate joint at the ship centreline. Each section is attached to the hull by hinge arms arranged to secure parallel motion when opening or closing with actuation by double-acting hydraulic cylinders.

Bow ramp/door

The bow ramp/door accessing the main **RoRo** deck comprises three sections plus end flaps, the inner section forming a **watertight door** at the **collision bulkhead**. The outer sections are disconnected from the first section and folded behind the bow door. The section forming the watertight door is thus physically separated from the other ramp sections, as prescribed by class rules.

Fixed length struts between the second section and the ship ensure the correct positioning and provide support during operation and stowage; the second section is locked to the deck above by hydraulic hooks. The third section is folded under the second by hydraulically-operated link mechanisms. In the deployed mode, all sections of the ramp are connected by hinges, allowing it to twist and cater for the ship heel.

Ro-ro access at the stern is provided at two levels, a wide ramp/door serving the main vehicle deck (3) and a narrower ramp serving the upper vehicle deck (5). Both single-section ramps are opened/closed by hydraulic cylinders on each side of the opening.

Tiltable ramp

Vehicle flows to and from the main and upper decks are facilitated by a large tiltable ramp. The single-section ramp can be lowered from either end due to the disconnectable hinges arranged forward and aft. Raising and lowering are effected by a wire and pulling-cylinder system. When closed, the ramp forms a weathertight closure in the upper deck.

The direct access into the upper vehicle deck is provided by two side ramp/doors installed port and starboard in the forward structure. The ramps are operated by hydraulic cylinders, launched from the stowed position by a push-out cylinder. As a door, the ramp stows **weathertight** in the shell.

A side-hinging ramp cover mounted aft on the main vehicle deck is arranged over a fixed ramp leading down to the lower hold (tanktop). Hydraulic cylinders attached to the longitudinal coaming impart the rotational movement to operate the two-panel cover, which is watertight in the closed position.

Forward, on the same deck, another watertight side-hinging ramp cover formed by three panels is installed above a hoistable ramp giving access to the lower hold. This hoistable ramp, arranged between the tanktop and a fixed ramp below the main deck, forms a part of the tanktop load area when lowered; when raised, it is deployed as a vehicle ramp linking the tanktop, main deck and upper deck.

Stores handling

MacGREGOR outfit extends to deck 8 aft of the superstructure where a hydraulically-operated provision hatch cover is installed to allow containers to be lowered and hoisted to and from a handling area below on deck 7.

Serving the engine stores from the main deck is a scissors platform lift with a capacity of 2000kg and a lifting height of 0-3m, manoeuvred by built-in hydraulic cylinders. A hydraulically-operated side-hinging cover closes watertight over the lift trunk.

Length, oa: 190.75m, Length, bp: 175.00m, Breadth, mld: 29.50m, Depth to main deck: 14.65m, Draught design/scantling: 6.20/6.30m, Deadweight at 6.20m: 7200dwt, Gross tonnage: 36,648, Service speed: 22 knots, Total lane length: 2613m, Total output: 29,680kW.

Rope guard – A two-part rope guard with ample overlap on the propeller hub protects the sterntube aft seal against mechanical damage in the event of a rope fouling the propeller.

Ro-ro – Abbreviation for a vessel designed to carry vehicles, so arranged that the vehicles may be loaded and unloaded by being rolled on or off on their own and/or auxiliary wheels, via ramps fitted in the sides, bow or stern of the vessel. A ro-ro vessel has one or more decks either closed or open, not normally subdivided and generally running along the entire length of the ship. In this type of vessel, **damage stability** becomes critical when large portions of the vessel, such as garages and holds are flooded.

Roll-on/roll-off system was first introduced in 1950s and the first modern oceangoing ro-ro vessel was the twin-screw USNS COMET built in 1958 to carry military vehicles. Ro-ro vessels transport wheel-based cargo or cargo that is loaded with wheel-based equipment, and available cargo space is expressed in lane meters. Typical cargo are vehicles, roll trailers and cassettes with forest products or with single or double stacked containers.

Cargo is literally rolled on board ro-ro ships. Sometimes roll trailers and cassettes loaded with cargo are stowed by forklift directly on the ro-ro deck. This is called Sto-Ro handling (Stowable Ro-Ro).

As the efficient cargo handling is most important for ro-ro vessels, these ships have large unrestricted cargo decks without transverse bulkheads. Usually, the ro-ro cargo is loaded and unloaded over the stern ramp, sometimes as wide as the entire cargo space. Internal ramps or elevators are used to reach the upper and lower cargo decks. For really fast cargo handling, two level ramps can be used. Special ramps on the quay are required to facilitate this.

Many ro-ro vessels operate on short trades with frequent port calls. Most of them are equipped with both thrusters and some have also stern thrusters. Usually, they are fitted with high lift rudders in order to ensure good manoeuvring characteristics also at low speeds.



Designed and built by Gdańsk Shipyard



Photos: P-H. Sjöström

Ro-ro freighter MIRANDA

RO-RO



Photos: P-H. Sjöström



MacGREGOR RO-RO OUTFIT ON FERRY ULYSSES

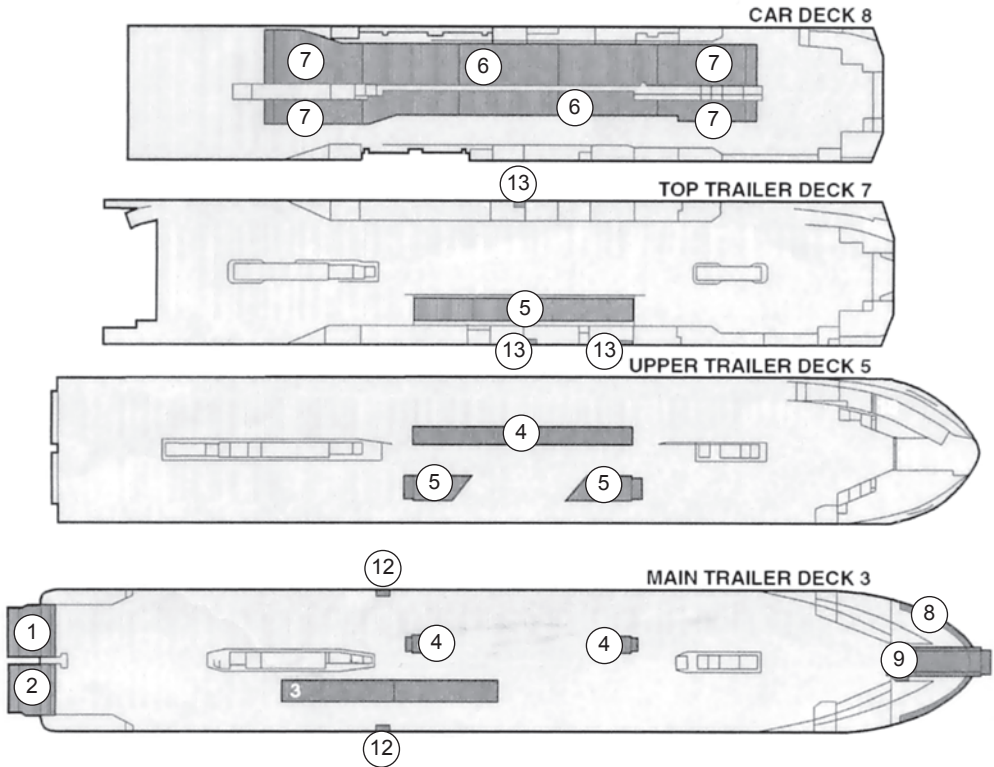
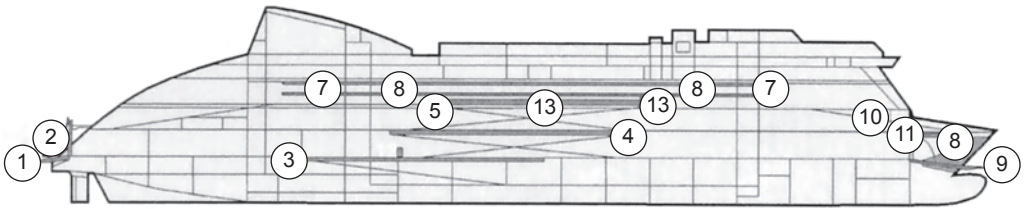

1. Stern ramp PS
2. Stern ramp SB
3. Side-hinged ramp cover
4. Hoistable tilting ramp
5. Hoistable tilting ramp
6. Hoistable car decks
7. Hoistable deck access ramps
8. Bow doors
9. Bow ramp
10. Upper front door
11. Front door
12. Pilot/bunker door
13. Passenger doors

The location of the **accommodation** varies and can be either in the stern, amidships or at the forward end. All versions exist, but the forward location has become popular in recent deliveries. The forward accommodation does not disturb the cargo flow and provide protection from **green water** for the cargo on the upper deck.

Ro-ro cargo handling gear, ro-ro equipment, cargo access/transfer equipment – An equipment fitted on ro-ro vessels to ensure access and movement of vehicles on board. A typical cargo system consists of a stern ramp/door, internal ramps or elevators and flood control doors. Bow door and bow ramp can be fitted, allowing for drive-through loading/unloading operation.

The ro-ro freight ferry NORSKY has a capacity of 2630 lane metres, representing 210 trailers, arranged over three freight decks, connected by fixed internal ramps. The cargo access equipment comprises a pair of hydraulically-operated stern ramps which are 16m long (including 3m flaps). The wider starboard ramp serves the main deck, providing a driveway which is 11.51m wide at the shore end, widening to just under 13.5m at the ship threshold. The narrower port side ramp has a shore end driveway width of 4.32m, widening to 6.17m. This ramp leads directly to the fixed ramp accessing the upper deck. The access from the main deck to the lower hold is provided by a fixed ramp starting aft on the starboard side. This ramp has a watertight two-panel side-hinged cover, 48m long and 5.8m wide, operated by hydraulic cylinders, which closes over the opening.

According to the Motor Ship October 1999.

Ro-ro cargo securing equipment –Trailer trestles, support jacks, speedlash, wheel chocks.

Ro-ro cargo spaces – Spaces not normally subdivided in any way and extending to either a substantial length or the entire length of the ship in which goods can be loaded and unloaded normally in a horizontal direction.

Open ro-ro cargo spaces – Spaces either open at both ends, or open at one end and provided with adequate natural ventilation effective over their entire length through permanent openings in the side plating or deckhead to the satisfaction of the **Administration**, (SOLAS).

Closed ro-ro cargo spaces – Spaces which are neither open ro-ro cargo spaces nor weather decks, (SOLAS).

Ro-ro carrier SPAARNERBORG

Built by Flender Werft at Lubeck, the 12,500dwt SPAARNERBORG is an innovative **ro-ro** ship; designed to carry paper and card supplies in specially-manufactured 90t Stora Enso cargo units (**SECU**). The vessel has three cargo decks which are designed to take SECUs, trailers, MAFI trailers and platforms. They can also accommodate cars, trucks, containers and general cargo. The total cargo capacity comprises 180 trailers, or 136 SECUs.

In order to provide a large volume of squared-off cargo space on three decks with no obstructions, the **accommodation** and the **machinery spaces** are placed forward. This unusual arrangement calls for the adoption of a 125m long **propeller shaft**, carrying the drive from the Wärtsilä 7RTA52U main engine to the Wärtsilä Lips four-bladed CP propeller. The propeller shaft stretches far out of the hull and is held by a single bracket. This solution reduces the wetted surface by about 4% compared to a conventional stern form.

With the forward **superstructure** and engine room, the fully-loaded ship is ballast free, and every intermediate condition can be reached with minimum ballast. Other interesting

Ro-ro freighter TOR MAGNOLIA

features are the mooring deck aft, raised above the upper deck in the form of a bridge in order to give clear access from the shore ramps, and flume tanks positioned at the aft end of the superstructure to counteract **roll**.

SPAARNERBORG has a direct access to the main deck through a Hamworthy KSE combined door and **ramp**. The ramp has finger flaps at both ends, and the overall length is 16m including flaps, with a driveway width of 22.7m. It can be worked at +/- 10 deg from the horizontal.

The access to the upper deck is provided directly from the shore over a specially designed two-level shore-based ramp constructed at the harbour in Goteborg, which is non-tidal, and a **linkspan** is used at tidal Zeebrugge.



Photo courtesy of Wärtsilä Corporation

The ro-ro paper product carrier SPAARNEBORG and her two sisters are each powered by a Wärtsilä Sulzer 7RTA52U main engine of 10,920kW, and two Wärtsilä 6L20 auxiliary engines, each of 980kW. All engines are equipped with SCR systems to reduce NOx emissions to the minimum

The access to the tanktop is down two large (52m x 8.60m) fixed ramps each side of the centerline near the stern door. To ensure a watertight main deck, two large ramp covers, hinged at their forward ends, are fitted. The complete package is operated hydraulically from a power pack in the small aft machinery space.

The main engine develops 10,920 kW at 135 rev/min and drives a shaft generator from the free end through a **gearbox**. Two diesel-driven **alternators** are also fitted, all three units producing 1120 kW each. The machinery installation is designed to be environmentally friendly. The main engine operates on low sulphur heavy oil, and exhaust emission treatment (**selective catalytic reduction**) is provided for both main and auxiliary engines.

Length, oa: 183.40m, Length, bp: 173.40m, Breadth, mld: 25.20m, Depth to main deck: 9.30m, Draught design/scantling: 7.50/7.80m, Deadweight design: 12,500dwt, Service speed (85%MCR): 18knots, Crew: 14, Drivers: 10.

Ro-ro freighter TOR MAGNOLIA

TOR MAGNOLIA and its sisters were built by the German shipyard Flensburger Schiffbau-Gesellschaft for the Danish owner DFDS Tor Line.

256 x 14m-long trailers can be stowed on the four fixed decks with a total capacity of 3831 lane-metres. In addition, two hoistable decks are fitted forward the engine casing providing 2660 lane-metres for 300 cars. All the vehicle decks are fitted with SAT lashing pots that secure trailer trestles.

The vehicle access is over the stern at main deck level by means of a single 18.10m wide x 14m long ramp supplemented by two 4.3m wide x 4m hinged side doors forward. A clear height above the main deck allows double-stack MAFI trailers to be loaded. The tanktop is reached from the main deck by a fixed ramp. Links with the upper deck are provided by a fixed 4m wide internal ramp and a 4m wide x 61.5m long hoistable ramp, which is in direct line with another fixed ramp taking vehicles to the weather deck. The direct access to the upper deck is also possible using an 8m wide shore linkspan over the stern.

Photo courtesy of Flensburger Schiffbau-Gesellschaft



Photo courtesy of Flensburger Schiffbau-Gesellschaft



RO-RO FREIGHTER TOR MAGNOLIA

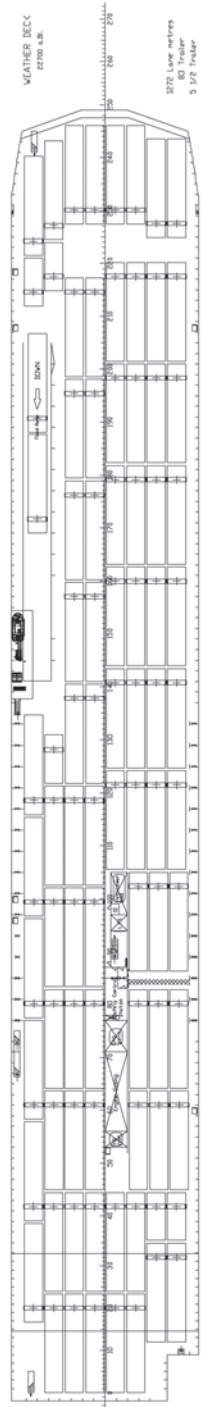
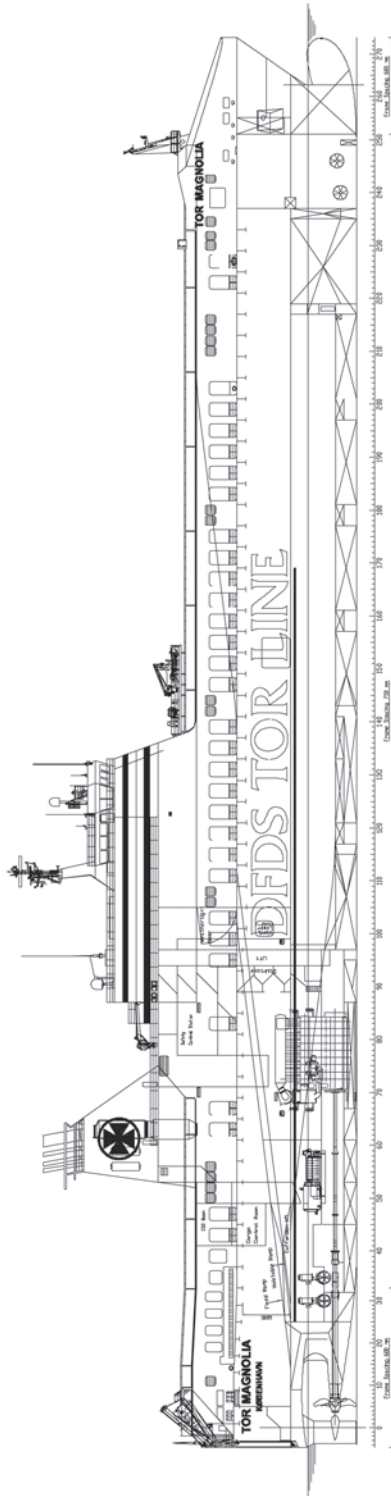
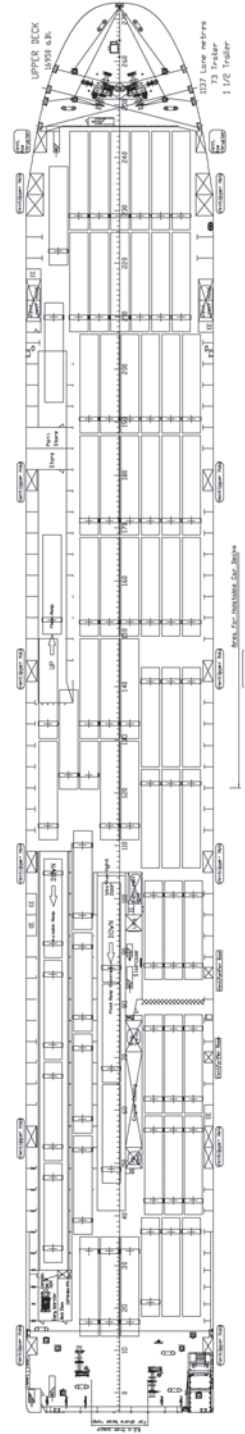
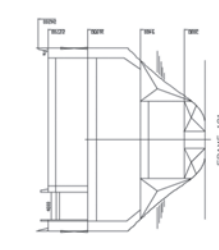
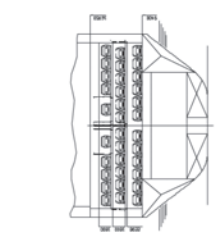
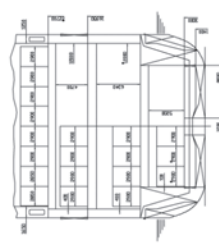
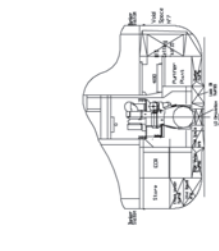
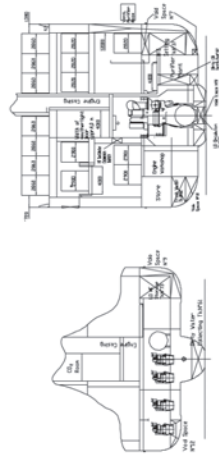
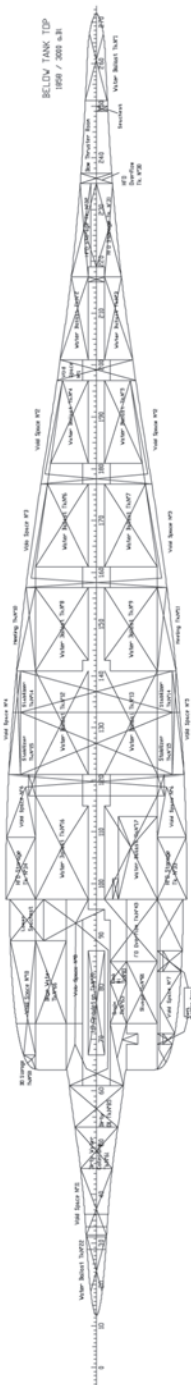
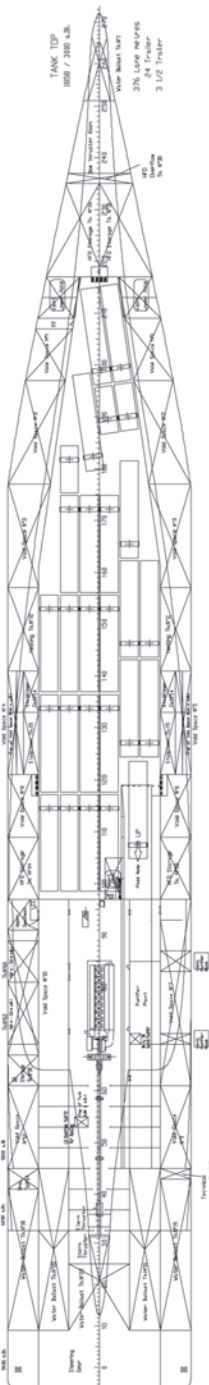

Illustration courtesy of Flensburger Schiffbau-Gesellschaft





Ro-ro passenger ship

A hull form and propulsion system has been developed by the shipyard in conjunction with research facilities at local universities and the ship model basin HSVA in Hamburg. The aft-body incorporates a single-skeg and a soft tunnel beneath the transom. The main features of this arrangement include reduced wave patterns, an even **wake field** and excellent water flow to the propeller.

The fitting of a new asymmetric section rudder is also interesting. The leading edge is twisted to gain maximum advantage from the rotational energy of the water behind the propeller. Two 1500kW **bow thrusters** and two 900kW stern thrusters, all fitted with CP propellers, assist the manoeuvring qualities. Seakeeping qualities are claimed to be excellent thanks to the fine hull shape and an **Intering anti-heeling** and **roll stabilisation** system.

The unusual power plant for this class of vessel consists of a single two-stroke 9L60MC-C engine producing an output of 20,070kW at 123 rpm and driving 6.1-metre diameter CP propeller. Auxiliary machinery consists of four 1520kW 7L21/31 diesel-alternator sets, fitted with catalytic converters.

Fully equipped superstructure forming a **bridge** over the otherwise open weather deck was built by Holm Construction in Gdańsk, Poland. It provides accommodation for 17 officers and crew, and for 18 passengers in 12 cabins.

Length, oa: 199.80m, Length, bp: 190.29m, Breadth, mld: 26.50m, Depth to main deck: 9.40m, Depth to upper deck: 16.95m Draught design/scantling: 6.95/16.95m, Deadweight design/scantling: 8780/10407dwt, Service speed (90%MCR, 15% sea margin): 22.80 knots.

Ro-ro passenger ship – A passenger ship with **ro-ro cargo spaces** or **special category spaces**, (SOLAS).

Rotary bow rudder system – The rotary bow rudder system is based on the principle of the Magnus Effect. A differential pressure is generated through a fast rotating cylinder operating in the incoming water current, resulting in a thrust effect. This thrust effect or sideways-created steering power is larger than that of a conventional rudder. The rotary bow rudder system has been developed by A. Van der Velden, especially for inland vessels with large wind surface areas, such as vessels operating in light draught condition and pusher barge convoys. One or two retractable rotary bow rudders are located in a recess in the vessel bottom bow section. The system further includes a hydraulic unit for drive, a starter/electronic cabinet for steering control, and a control panel mounted in the **wheelhouse**.

Rotary pump – A positive displacement pump. For each revolution of the pump, a fixed volume of fluid is moved regardless of the resistance against which the pump is pushing. It is self-priming, and gives practically constant delivered capacity regardless of the pressure. The rotary pump consists of a fixed casing containing gears, cams, screws, plungers or similar elements actuated by rotation of the drive shaft. A number of pump types are included in this classification, among which are the **gear pump**, the **screw pump**, and the **rotary vane pump**.

Rotary pumps are useful for pumping oil and other liquids of high viscosity. In the engine room, rotary pumps are used for handling lube oil and fuel oil and are suitable for handling liquids over a wide range of viscosities. Rotary pumps are designed with very small clearances between rotating parts and stationary parts to minimize leakage (slippage) from the discharge side back to the suction side. Rotary pumps are designed to operate at relatively low speeds to maintain these clearances. The operation at higher speeds causes erosion and excessive wear which result in increased clearances

with a subsequent decrease in pumping capacity. Classification of the rotary pumps is generally based on the types of rotating element.

Gear pump – The simple gear pump has two spur gears that mesh together and revolve in opposite directions. One is the driving gear, and the other is the driven gear. Clearances between the gear teeth (outside diameter of the gear) and the casing and between the end face and the casing are only a few thousandths of an inch. As the gears turn, they unmesh and liquid flows into the pockets that are vacated by the meshing gear teeth. This creates the suction that draws the liquid into the pump. The liquid is then carried along in the pockets formed by the gear teeth and the casing. On the discharge side, the liquid is displaced by the meshing of the gears and forced out through the discharge side of the pump.

Rotary vane pumps – The rotary vane pump has a cylindrically-bored housing with a suction inlet on one side and a discharge outlet on the other side. A rotor (smaller in diameter than the cylinder) is driven about an axis that is placed above the center line of the cylinder to provide minimum clearance between the rotor and cylinder at the top and maximum clearance at the bottom. The rotor carries vanes (which move in and out as the rotor rotates) to maintain sealed spaces between the rotor and the cylinder wall. The vanes trap liquid on the suction side and carry it to the discharge side, where contraction of the space expels liquid through the discharge line. The vanes slide on slots in the rotor. Vane pumps are used for lube oil service and transfer, tank stripping, bilge, and in general, for handling lighter viscous liquids.

Screw pump – There are several different types of screw pumps. The differences between the various types are the number of intermeshing screws and the screw pitch. Screw pumps are used aboard ship to pump fuel and lube oil and to supply pressure to the hydraulic system. In the double-screw pump, one rotor is driven by the drive shaft and the other by a set of timing gears. In the triple-screw pump, a central rotor meshes with two idler rotors. In the screw pump, liquid is trapped and forced through the pump by the action of rotating screws. As the rotor turns, the liquid flows in between the threads at the outer end of each pair of screws. The threads carry the liquid along within the housing to the center of the pump where it is discharged. Most screw pumps are now equipped with mechanical seals. If the mechanical seal fails, the stuffing box has the capability of accepting two rings of conventional packing for emergency use.

Rotary table – A large casting located centrally within the drill floor used to impart rotary motion to the **drill string**, being chain driven from the draw-works.

Royal Institution of Naval Architects (RINA) – The British association founded in 1860 to promote the improvement of ships and everything that relates to them. RINA organises many international conferences, seminars and training courses covering all aspects of naval architecture and maritime technology. It publishes technical papers, books and journals; The Naval Architect, Ship & Boat International, and Shiprepair and Conversion Technology.

Address: The Secretary, 10 Upper Belgrave Street,
LONDON SW1X 8BQ. www.rina.org.uk

Rudder – A device used for steering and manoeuvring a vessel. Rudders are hydrofoils which are pivoting on a vertical axis. They are located normally at the stern behind propeller(s)

to produce a transverse force and steering moment about the ship centre of gravity by deflecting the water flow to the direction of the foil plane.

Rudder effectiveness can be improved by:

- rudder arrangement in the propeller stream,
- increasing the rudder area,
- better rudder type (e.g. spade rudder instead of semi-balanced rudder, high lift profiles or flap rudders),
- steering gear which allows larger rudder angles than the customary 35°,
- shorter rudder steering time (more powerful hydraulic pumps in steering gear).

Rudders are one of the areas where extra investment spent on getting the right equipment can pay back the shipowner many times. One of the basic problems is deciding whether to optimise the rudder for the service speed or for low-speed manoeuvring. Many rudder configurations can meet guidelines for turning circles and zig zag, but still not be optimum for the ship service profile. For ships like VLCCs and container vessels, the majority of service is course keeping. Consequently, rudder angles during normal course keeping and manoeuvring operation are limited to 35deg. For some service profiles good slow speed performance is very important and high rudder operating angles will give greater benefit.

Balanced rudder – A rudder with a part of the blade surface put forward of the axis so the water pressure on this portion counterbalances that on the after part.

Becker rudder – A spade-type rudder with flap. The Becker-type rudder has a moving flap on the trailing edge. When the rudder moves, a mechanical linkage diverts the flap to a higher angle to maximise the sideways thrust. Either 45 deg or 65 deg maximum rudder angles can be specified for bigger and faster rudders.

Flap rudder – A high-lift rudder developed by German flap rudder specialist Willi Becker. It consists of a blade with a trailing edge flap activated by a mechanical or hydraulic system, thus producing a variable flap angle as a function of the rudder angle. Flap rudders give a much higher lift per rudder angle and a 60% to 70% higher maximum lift compared to the conventional rudder of same shape, size and area. In addition, the high balanced area improves manoeuvring characteristic at the low speeds by blocking the forward thrust of the propeller. High-lift flap rudders are specified for vessels which require better manoeuvrability than a conventional rudder, can provide.

Flettner rudder – A special design of flap rudder which uses two narrow flaps at the trailing edge, one above the other.

Schilling rudder, also fishtail rudder – In the Schilling-type there is no flap, but the trailing edge is formed in a fishtail shape that accelerates the flow and recovers the lift over the aft section of the rudder. With operating angles up to 70 deg, the Schilling rudder dramatically improves both the course keeping and the vessel control characteristics.

Semi-spade rudder with simple pintle – The semi-spade rudder is supported by a horn. It consists of a rudder blade with a pintle and the vertical shaft (the rudder stock) which connects blade with the steering gear. The rudderstock is made of forged steel. A key is fitted on in way of tiller. Stainless steel sleeves are used in way of bearings.

The cone coupling is used to fasten the rudder blade to the rudderstock. The lower part of the rudderstock is inserted into a solid part belonging to the blade and locked by a nut and key. A keyless rudder stock – blade coupling may be accepted by a classification

RUDDERS



Flap-type spade rudder

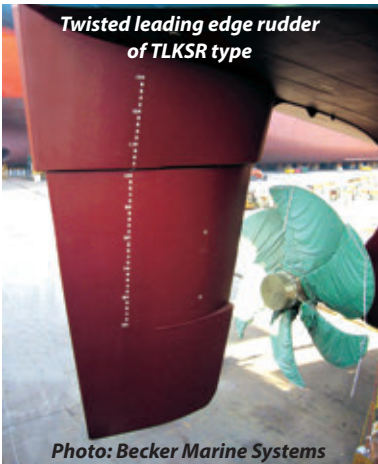

society. The contact area of conical connection between the blade and the rudderstock is to be verified by means of paint test (minimum 70%).

To the large extent the thickness of a rudder blade is dictated by the rudder stock diameter which in turn, is a function of the torque required and the bending moment. A streamlined rudder blade consists of side plates stiffened by internal vertical and horizontal web plates and solid parts in cast steel which ensure the housing of the rudderstock and the pintle. Means for draining the rudder blade after pressure testing or possible leakages is to be provided.

The pintle is fastened to the rudder blade by a conical coupling secured by a nut. Before the final mounting of rudder pintle, the contact between the conical surface of the pintle and its housing is to be checked by marking with Prussian blue or a similar method. The pintle and the nut are to be efficiently locked against rotation.

The semi-spade rudder has smaller movable area than the comparable spade rudder resulting in lower maximum lift generated at high steering angles. In normal operation, the propulsion power loss due to a rudder is lower than with a spade rudder because of the thinner profile. Use of thinner profile is possible because of rudder horn carrying the rudder forces instead of rudderstock. When selecting profile a good alternative is NACA 63-021 and thinner profiles. These profiles allow quite the high variation (3-5°) in angle of attack with no change in drag coefficient.

Semi-balanced rudder – A rudder with part of the blade positioned forward off the turning axis.

Spade rudder – To maximise the rudder force at high rudder angles a spade-type rudder is usually selected. This kind of a rudder can act as a “reaction blade” by deflecting propeller outflow using its total movable area. Especially if equipped with a flap, this type of a rudder offers the best crabbing performance. Disadvantage of the spade type rudder is thick profile and often unfavourable profile shape from resistance and propulsion point of view. A thick profile results from a rudderstock that has to have large diameter in order to carry the rudder forces. Becker Marine Systems uses KSR technology for bigger and faster ships for flap rudders and full spade rudders, achieving rudder thickness even lower than in case of semi-spade rudders.

TLKSR rudder – A new type of fully-spade rudder developed by Becker Marine Systems. TLKSR rudder combines the twisted leading edge technology with the Becker King Support Rudder arrangement. The KSR arrangement extends the rudder trunk into the rudder blade so that the main neck bearing is positioned close to the hydrodynamic centre of pressure on the rudder blade. This results in reduced stress and bending moments in the rudder blade structure.

Twisted leading edge rudder – In contrast to conventional symmetrical rudders, the twisted rudder comprises a special asymmetrical section offset to port and starboard at the leading edge along the rudder span. This feature results in improved pressure distribution on the rudder surface from the rotational propeller flow, thereby improving resistance, manoeuvrability and cavitation qualities.

Rudder actuator – A hydraulic cylinder or a hydraulic motor which directly converts hydraulic pressure into mechanical action to move the rudder.

Rudder angle indicator – A device used to indicate the present position of the rudder blade, usually fitted in the **wheelhouse**, bridge wings and engine control room.

Rudder blade – The main part of the rudder which provides the necessary surface for the impinging action and side pressure of the water. A streamlined rudder blade consists of side plates stiffened by internal vertical and horizontal web plates and solid parts in cast steel which makes the housing of the rudderstock and the pintle.

Rudder blade sole should be rounded at the leading edge in order to avoid local cavitation and erosion. The contact area of conical connection between the blade and the rudderstock is to be verified by means of blueprint test (minimum 70%). Internal surfaces are to be covered by a corrosion-resistant coating. Means for draining the rudder blade after pressure testing or possible leakages are to be provided.

Rudder blade area – There are no regulation for the rating of the rudder area and very often crude empirical methods such as percentage of the underwater lateral area are used. Det Norske Veritas recommends:

$$\frac{AR}{L \times T} = 0.01 \left[1 + 25 \left(\frac{B}{L} \right)^2 \right]$$

This gives a rudder blade area of approximately 1.5% of the underwater lateral area $L \times T$ for ships of usual width; for the unusually broad ships (large mass, large windage area, low yaw stability) a somewhat larger value is given. This corresponds to typical rudder designs and can serve as a starting point for further analyses.

Rudder carrier – A fitting placed inboard (on the steering gear deck) which carries the whole weight of the rudder and the tiller. Rotary vane steering gears and some RAM-type steering gears have the rudder carrier integrated.



Photo: J. Babicz

Rudder horn – A welded construction or a casting providing support for the rudder blade and minimises the bending moment in the rudderstock.

Rudder propeller – Rudder propellers are azimuthing ducted or free-running propellers in a fixed or hinged vertical position. They are active control devices with a directed thrust.

Rudder roll stabilisation – An adaptive control system that uses the existing steering gear and **rudder**. The operating principle of the rudder roll stabilisation is based on the concept of opposing the roll moment created by the waves with an induced roll moment developed by the movement of the rudder, thereby damping the ship roll motions. When using a rudder roll stabilisation system, the load on the steering gear and rudder increases.

Rudder sole cavitation – If the rudder blade has a sharp corner at the front lower edge, the flow cannot follow the sharp bend from the leading edge to the base plate causing cavitation in the front part of the rudder sole. A precaution measure is to bend the base plate upward at its front end and to round the weldings at this location. A further improvement could be obtained by using a smoothly rounded lower face.

Rudderstock – A vertical shaft through which the turning force of the steering gear is transmitted to the rudder blade. The rudderstock is to be made of forged steel. Connection to the rudder blade is provided by hydraulic cone fit, connection to the tiller or actuator by hydraulic cone fit, a key connection, or by clamping rings for smaller rudders.

Rudder stop – A lag on the stern frame or a bracket on deck at each side of the quadrant, to limit the swing of the rudder to approximately 37 deg port or starboard.

RULFINDER – An interactive PC-based software system developed by **Lloyd's Register**. With the increasing volume and complexity of marine classification and statutory regulations, identifying the latest marine regulations can be an unpleasant task – difficult, time consuming and expensive. Rulefinder provides immediate fast and easy searchable access to an extensive library of consolidated versions of the latest requirements from both Lloyd's Register and the International Maritime Organization. It is updated and released in January and July every year.

Rule of thumb – A method established, or a procedure derived entirely from practice or experience not based on scientific knowledge; a roughly practical method.

Rust – A visible corrosion product consisting of hydrated iron oxides. Rust is formed on steel surfaces exposed to moist atmospheric conditions.

Rust grades (according to Swedish Standard 055900-1967):

A: Steel surface covered completely with adhering mill scale and with little or no rust.

B: Steel surface which has started to rust and from which the mill scale has begun to flake.

C: Steel surface where the mill scale has rusted away or from which it can be scraped with little pitting visible to the naked eye.

D: Steel surface where the mill scale has rusted away and where pitting is visible to the naked eye.

Grade A is normally the condition of the steel surface a short time after rolling. Grades B, C and D are normally the state of the surface after it has been exposed outdoors, without protection against rusting in a fairly corrosive atmosphere for two or three months, then a year or so, and about three years, respectively.

S-57 Standard Format – A type of electronic navigational chart (ENC) format.

The S-57 digital chart is a vector format based on the S-57 object model. This model defines hydrographic information as a combination of descriptive and spatial characteristics. Within the model, these sets of characteristics are defined in terms of objects separated into a feature and a spatial part. The feature part of an object contains descriptive attributes and no geometry, whereas the spatial part mainly contains geometry of type vector and may have additional descriptive attributes.

These objects are independent of the actual representation on the screen. This information is provided separately. An S-57 electronic navigational chart is also called a cell which has a defined geographical coverage and navigational purpose or usage. A cell is a rectangle, i.e. defined by two meridians and two parallels and its data not exceed 5 Megabytes. The data of cells of same usage do not overlap making a continuous chart display possible. The chart data in S-57 format is usually digitised from a paper or a raster chart, or may be created directly from the survey data and object databases.

Sacrificial anode – The anode made of metal less noble than steel in the galvanic series (zinc or aluminium). The anode corrodes when submitted to galvanic current and so protects the immersed steel structure.

Sacrificial anode cathodic protection – A metal can be made cathodic by electric connecting to a more anodic metal within the electrolyte. The most commonly used anodic metals are aluminium alloys, zinc and magnesium. Anodes of these metals corrode preferentially. They deteriorate as an essential part of their function and they are therefore termed sacrificial.

Safe Anchor Handling System (SAHS) – Handling of rig **anchors** is one of the most demanding and dangerous tasks performed in the marine service industry. Bourbon Offshore Norway AA, Ulstein and handling equipment supplier ODIM have developed a new and safer solution to handling and retrieving anchors, which removes personnel from hazardous areas.

The most hazardous operation takes place when the heavy anchor is weighed and has to be dragged over the stern and onto the deck. Enormous forces are involved and if a cable breaks, serious injuries may easily occur. In the new system, the anchor is brought onto deck in a controlled manner using the hinged stern ramp fitted with twin rollers. When the anchor reaches the top of the ramp, it is tilted forward and parked flush with the deck causing the anchor to come in right over the deck without having to be dragged over the deck edge.

For more information visit www.bourbon-offshore.no, www.ulsteindesign.com

Safe Return to Port (SRtP) – Capsizing of COSTA CONCORDIA and fire of engine room on board CARNIVAL TRIUMPH show that hundred years after tragic sinking of the ocean liner TITANIC passenger ships are still not sufficiently safe. “Safe Return to Port” means new **SOLAS** regulations applicable to new passenger ships having their keel laid on or after 1st July 2010, and having a length of 120m or more, or having 3 or more Main Vertical Zones. As per these regulations, a passenger ship shall be designed so that the essential systems remain operational after a fire **casualty** which does not exceed casualty

threshold or a flooding of any single **watertight** compartment and the ship is able to proceed to a safe port under their own power. This may sound simple in theory, but in reality poses a real challenge to ship designers.

A casualty threshold includes a loss of space of fire origin up to the nearest "A" class division if the space is protected by a fixed fire-extinguishing system, or a loss of the space of origin and adjacent spaces up to the nearest "A" class divisions which are not part of the space of fire origin if it is not protected by a fixed fire-extinguishing system.

During this "Safe Return to Port" period, all persons onboard are accommodated in a "safe area" where basic services for their safety and health are available. Safe areas are spaces (generally, internally located) where basic services such as food, water, sanitation, alternate medical care, lighting and ventilation are maintained.

If the casualty threshold is exceeded, SOLAS now requires some essential systems to be still operational for three hours in order to support the "orderly evacuation" of the vessel, considering one entire main fire zone lost.

However, it is necessary to understand that in case of long shallow side shell damage, ships without double sides in way of machinery spaces will capsize in the same way as COSTA CONCORDIA, even if built according to SRtP rules.

Further reading: *MSC.1/Circ.1369 INTERIM EXPLANATORY NOTES FOR THE ASSESSMENT OF PASSENGER SHIP SYSTEMS' CAPABILITIES AFTER A FIRE OR FLOODING CASUALTY*

Safe speed – The speed of a vessel allowing the maximum possible time for effective action to be taken to avoid a collision and to be stopped within an appropriate distance.

Safe Working Load (SWL) – The SWL for shipboard lifting appliances and heavy lift **cranes** is the load that each complete crane assembly is approved to lift on the cargo hook, excluding the weight of the gear (hook, block, wire, etc.).

The SWL for offshore cranes are the static rated load that each complete crane assembly is approved to lift on the cargo hook including the weight of the gear (hook, block, wire, etc.).

Safe working practice – An accepted working procedure which ensures a person to be able to perform a particular task safely and without being exposed to any unnecessary risks.

Safe working pressure – The maximum permissible pressure in cargo hoses.

Safety head – A device which in operating condition expels the gas at a velocity in excess of the flame propagating velocity of that gas mixture. In a closed condition the device is to form a **flame arrester**. See also **High velocity vent**.

Safety system – An automatic control system designed to automatically lead controlled machinery to a predetermined less critical condition in response to a fault which may endanger the machinery or the safety of personnel and which may develop too fast to allow manual intervention.

Safety workstation – Workstation on the bridge at which monitoring displays and operating elements of systems serving the ship's own safety are concentrated.

Safety zone – The area around an offshore installation within a radius of 500 m. Ships are prohibited from entry except under special circumstances, e.g. when in distress.

Sagging – A condition where the bow and stern are supported by buoyancy and the ship's middle portion is not. The upper deck is under compression, the bottom under tension.

Sagging can be caused by the cargo loading pattern or when the ship is in a seaway and the bow and stern sections are supported on adjacent wave crests.

Figure from IACS Recommendation 46: Bulk Carriers

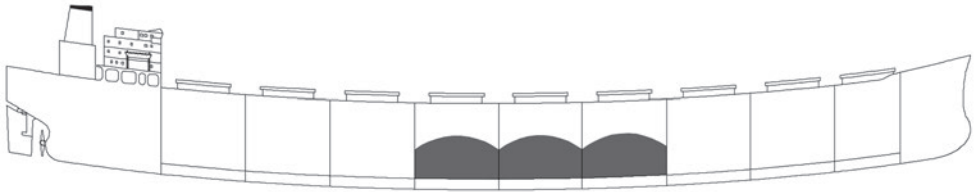

Sagging in still water created by the wrong cargo loading

Sags – Excess flow paint, also called runs or curtains.

Saimaa Canal – The Saimaa Canal runs through Russian as well as Finnish territory, and provides a direct route to and from ports located in the Saimaa Lake District. Key cargoes on the Saimaa system include timber, paper products, coal, raw minerals and mineral products. The 82.5m length overall is the maximum for the Saimaa, as is the 12.50m moulded breadth for various locks on the system. Draught 4.35m permits access to ports on the Finnish lakes.

Salinity – Concentration of salt in water. Measured in part per million (PPM).

Salinometer – An instrument which measures and indicates the amount of sodium chloride, expressed in parts per million, in a given sample of water. Electrical conductivity is the usual means of measurement.

Salvage – The money paid for assistance in saving a ship or other goods from danger at sea or the actual goods themselves.

Salvage Association – A body which acts, through its surveyors, to establish the nature, cause and extent of damage to a vessel and advice regarding repair or any means of determining the extent of loss.

Salvage operation – Any act or activity undertaken to assist a vessel or any other property in danger in navigable waters or in any other waters whatsoever.

Sampson-post, king post – A rigid vertical post used in place of a mast to support derricks.

Sand blasting – An abrasive cleaning method for steel plating which may use dry sand or sand and water mixture.

Sandwich Plate System, SPS deck overlay system – SPS is a composite structural laminate that replaces conventional stiffened metal plates. SPS uses a solid polyurethane elastomer core encased by metal faceplates. It is used in both newbuilding and repairs (SPS Overlay).

The SPS overlay technique was used on the ro-ro vessel EUROPAN NAVIGATOR which required the repair of its upper vehicle deck. Completed in only 20 days, UK-based Intelligent Engineering in unison with Cammell Laird laid down a total of 884m². The standard procedure was a single day of shot blasting, followed by five days of steel work preparation which continued alongside 14 days of elastomer injection.

For more information visit www.ie-sps.com

Sanitary discharges – Drain lines from toilets, bathrooms, **galley**, etc

The requirements as to the number and type of valves and their closing appliances are dependent on the lowest inboard opening of each discharge system in relation to the summer water line. The inboard opening (inboard end) is the lowest point where water could enter and flood the vessel if back-flooding was to occur due to valve failure in the line. This will normally be water closet, washbasin, drain from the showers, etc.

Sanitary pump

Sanitary pump – A pump which supplies seawater for flushing toilets.

Saturated steam – Steam that is at the boiling temperature associated with its particular pressure, i.e. the saturation pressure. It contains small quantities of water and is considered to be wet steam.

Saturation – The condition of air at any given temperature and water vapour pressure, when a reduction in temperature would cause condensation.

Scale – A numerical factor which relates the measured value to the actual value.

Scale – Surface oxidation, consisting of partially adherent layers of corrosion products, left on metals by heating or casting in air or in other oxidizing atmospheres. Scale is the product of the corrosion process of steel with a porous surface layer or flake, in volume greater than the metal from which it was formed.

Loose scale – Sheets of rust falling off if the surveyor hits the structure with his test hammer. Loose scale can best be removed by hand or power tool cleaning or a combination of these.

Mill scale – Thick oxide film formed on rough-metal products which have been hot-rolled or forged and allowed to cool in air.

Scallop – A hole cut into a stiffening member to allow continuous welding of a plate seam.

Scantlings – A marine term for the size and strength of structural elements: the dimensions of the ship frames, girders, stiffeners and plates.

Reduced scantlings – Scantlings that are allowed to be reduced because approved corrosion control arrangements have been applied.

Scavenge Air System – The integrated part of the main engine supplied with scavenge air from one or more turbochargers. The compressor of the **turbocharger** draws air from the engine room, through an air filter. From the turbochargers, the air is led via the charging air pipe, air coolers and scavenge air receiver to scavenge ports of the cylinder liners.

Scavenge fire – The fire of flammable mixture (cylinder oil, unburned fuel and carbon) which can collect in the scavenge space of an engine. Fire in the scavenge air space can be extinguished by steam, water mist or CO₂.

Scavenging – Removal of exhaust gases by blowing fresh air in.

Exhaust gas driven turbochargers are used to supply pressurised fresh air for scavenging and supercharging. In two-stroke diesels, an electrically driven auxiliary blower is usually provided because the exhaust gas driven turbocharger cannot provide enough air at low engine speed, and pressurised air is usually cooled to increase the charge air density.

Scavenging methods – Cross-flow scavenging, loop scavenging, uniflow scavenging. The uniflow one is the most efficient scavenging system but requires an exhaust valve in the cylinder head.

Uniflow scavenging – A scavenging system where the incoming air enters at the lower end of the cylinder and leaves at the top. The outlet at the top of the cylinder usually consists of a large valve.

Scene – The area where the event, e.g. an accident has happened.

Schneekluth duct – see **POWER-SAVING DEVICES**

Scissors platform lift – The elevator with a platform supported by a system of levers and hydraulic rams. Scissor lifts are usually located between the main deck and lower decks, stowing in a recess at the lower level.

Illustration courtesy of Wärtsilä Corporation

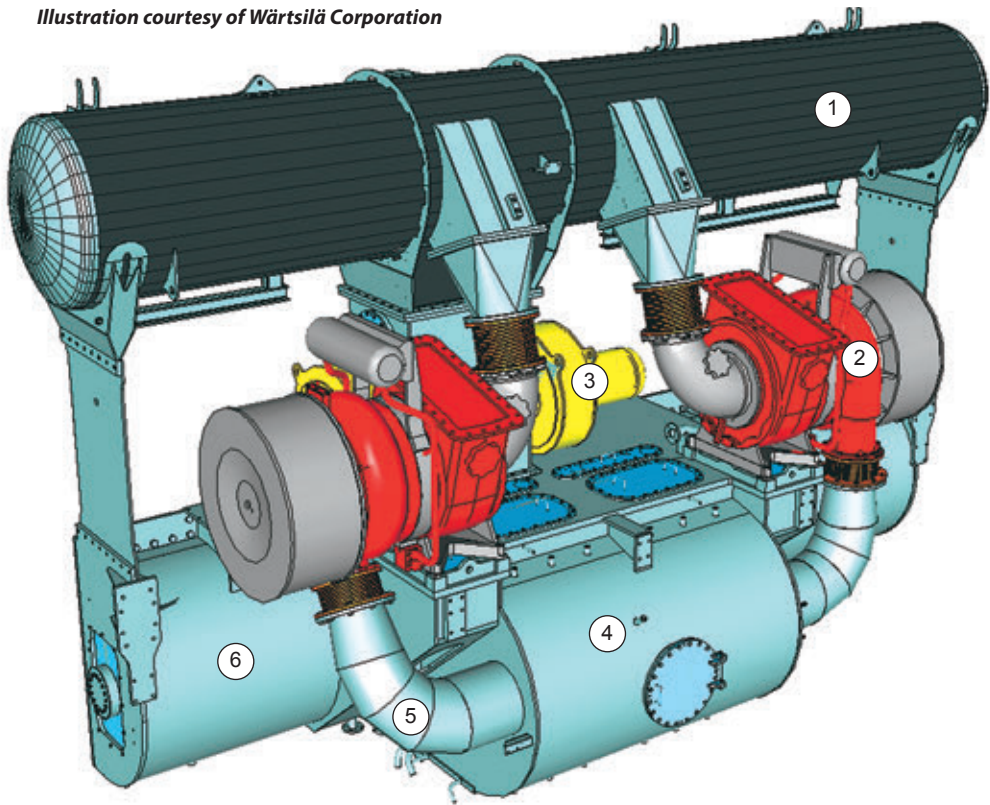

Complete scavenging system for Wärtsilä SULZER RT-flex60C engine, comprising exhaust manifold "1", two turbochargers "2", auxiliary blowers "3", scavenge air cooler "4", scavenge air pipes "5", and scavenge air receiver "6"

SCOLD – A container location device. The SCOLD unit is a compact radio beacon which should be attached to a container with hazardous or noxious cargo. If the container is lost from the ship, the SCOLD unit automatically activates itself on immersion in water and transmits a sonar beep which can be used to locate the container at any depth.

Scoop cooling – An alternative cooling system with a large opening in the bottom shell which admits sea water into a large-volume, low pressure circulating system. The forward motion of the ship will draw in water and a circulating pump is only required when the ship is moving slowly or stopped.

SCOT concept – The design concept of the safe tanker provided with redundant propulsion plants and steering gear. The SCOT (safety chemical oil tanker) initiative is a response to the tonnage replacement demand resulting from the impact of IMO regulations for the phase-out of single-hull tankers on the lower tonnage end of the scale, in the 5000-10 000dwt range. The SCOT design found the first form in the 8150dwt WAPPEN VON HAMBURG built by Damen's Galatz yard in Romania. The tanker is accredited with 100% engine and steering redundancy as well as a double bottom and double side shell.

Scrapper ring – A piston ring fitted at the lower end of a piston. It is used to remove excess quantities of lubricating oil from the cylinder walls and return it to the **crankcase**.

Screen plate

Screen plate – A metal plate of heat resisting steel, through which the superheater tubes of a boiler pass. It shields the headers from the direct heat of furnace and also minimizes the escape of gases into the machinery space.

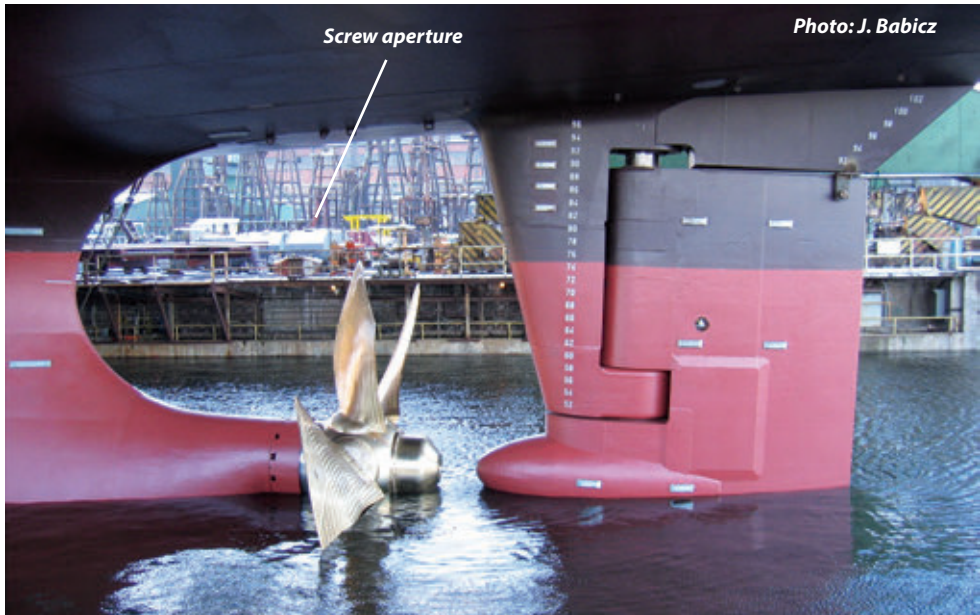

Screw aperture – The opening aft of the **stern frame** in which the **propeller** rotates. See also **Propeller clearances**.

Screw down non-return valve – A valve with a disc not attached to the spindle. The disc must have wings or guide to ensure it seats correctly when the valve is closed. The disc will reseat automatically if a reverse flow of liquid occurs.

Screw effect – A sideways thrust which results from the **propeller** rotation and affects the steering of a ship. It is most noticeable when close to the quay or in a narrow channel. See **side-thrust effect**.

Screw lift valve – A valve with a disc attached to the spindle. It gets fixed in any position set by moving the spindle.

Scrubber, scrubbing tower – A cleaning chamber in an **inert gas plant**. The purpose of the scrubber is to cool the flue gas and remove most of the sulphur dioxide and particulate soot. Seawater is used to scrub or remove contaminants from the gas before it passes to cargo tanks. See also **SO_x SCRUBBER SYSTEMS**.

Further reading: IMO Guidelines for Inert Gas Systems.

Scum valve – A boiler mounting used to remove scum from the water surface. A shallow dish is positioned at the normal water level and connected to the valve.

Scuppers – Drains from decks to carry off accumulations of rainwater, condensation or seawater. Scuppers are located in the gutters or waterways, on open decks and connected to pipes usually leading overboard, and, in the corners of the enclosed decks to the bilge.

When leading from an exposed deck or non weathertight spaces, scuppers are to be led overboard and do not need to be provided with valves as long as they consist entirely of pipes of the substantial thickness below the freeboard deck.

Scuttle – A small circular or oval opening in a deck or elsewhere, usually fitted with a cover or lid or a door for access to a compartment.

SEA-Arrow bow (Sharp Entrance Angle bow as an Arrow) – The new shape of LPG carrier bow developed by Kawasaki Shipbuilding in order to decrease wave resistance at the bow without the bulb while allowing cargo tanks to extend to the foremost point of the vessel. Built at Kawasaki's Sakaide yard, the 80,138m³ LPG carrier CRYSTAL MARINE is the first vessel with SEA-Arrow bow. Kawasaki adopted the same fore-end configuration for the handymax bulker BIG GLORY delivered in 2005.

Sea Axe – The Sea Axe, also referred to as axe bow, is a new ship type developed by professor Keunig from the University of Delft in collaboration with the High Speed & Naval Craft Department of Damen shipyards Gorichem. The initial goal of the design exercise was to achieve a high service speed in rough seas by reducing the vertical acceleration onboard. These accelerations are the prime cause of sea-sickness and also the reason for voluntary speed reduction onboard fast vessels in rough sea. The pitching movement was reduced by creating a nearly wedge-shaped bow, with minimal flare above waterline, a very fine entry angle and deep bow sections. Oncoming waves therefore generate less lift in the bow sections, significantly reducing accelerations due to pitching. The freeboard in the bow has been increased to avoid shipping "green water". As this vessel sails more through the waves than over them.

Sea chest, sea inlet box – An enclosure, attached to the inside of the underwater shell and open to the sea, fitted with a portable strainer plate. A sea inlet valve and piping connected to the sea chest directs sea water into the ship for the cooling, fire or sanitary purposes. Compressed air or steam connections may be provided to remove ice or other obstructions.

Sea-going vessel – Vessel navigating on the high seas, i.e. areas along coast and from coast to coast.

Sea island – A pier structure without a direct connection to the shore at which tankers can berth. Berthing can take place either on one or both sides of the structure.

Sea margin – A provision for an increased resistance caused by wind, sea state, fouling of hull and **propeller**, shallow water, currents, etc. Usually a sea margin of 10-25% is applied.

Sea state monitoring systems, wave monitoring systems – Radar-based systems to determine the exact sea state around the ship in order to avoid hull and cargo damage caused by heavy weather.

The Miros system has eight readouts: significant and maximum wave height; mean zero up-crossing and primary wave peak period; primary wave velocity and peak direction; and total energy peak direction and spread.

Sea suction – The aperture through which sea water is drawn or the part of a pumping system which admits seawater into it.

Sea Trial Program – Sea trials are carried out after the **dock tests** to demonstrate proper operation of the main and auxiliary machinery, including monitoring, alarm and safety systems, under realistic conditions. The trials are also to demonstrate that any vibration which may occur within the operating speed range is acceptable.

The sea trials are to include demonstration of the following:

- The adequacy of the starting arrangements to provide the required number of starts of the main engine.

- The ability of the machinery to reverse the direction of thrust of the **propeller** in sufficient time, and so bring the ship to rest from maximum service speed.
- Where controllable pitch propeller is fitted, the free route astern trial is to be carried out with the propeller blades set in the full pitch astern position.
- In geared installations, prior to full power sea trials, the gear teeth are to be suitably coated to demonstrate the contact markings, and on conclusion of the sea trials, all gears are to be opened up sufficiently to make for an inspection of the teeth.

Further reading: GL Guidelines for Sea Trials of Motor Vessels.

From BNC Technical Specification:

1. *Speed trials and manoeuvring trials should be made with no wind and sea as still as possible.*
2. *Manoeuvring trials are to be performed according to the IMO Res. Res. MSC.137(76) "Standards for Ship Manoeuvrability", and will be carried out for the first ship only.*
3. *The scope of the sea trials and inspections after sea trials will be specified in the Sea Trial Program that is to be prepared by the Shipyard and submitted for Owners approval 2 months before sea trials.*
4. *Sea trials will be carried out when all dock tests are completed with positive results. In a justified case agreed with Owners, a dock test can be carried out during sea trials.*
5. *The Shipyard is to give Owners and Class Society a three-week notice of the date of sea trials and to confirm it seven days before the date.*
6. *Speed trials are to be performed in sufficient deep water.*
7. *Noise and vibration measurements will be carried for all ships. However, in case of good results on the first ship, these measurements can be suspended by Owners for the sister ships.*
8. *In case of any breakdown that can be repaired at sea, sea trials shall be continued after repairs and remain valid in all respects.*
9. *Unsuccessful sea trials will be repeated when faults/claims are rectified, within a scope necessary to confirm that corrections are made properly.*
10. *After finishing sea trials, the Shipyard shall prepare the document entitled Sea Trial Results.*

Seafarer – A person who works on ships for a living.

Seakeeping – Ship behaviour in rough weather. Seakeeping covers various aspects of performance in waves such as **slamming**, deck wetness, speed and power, **propeller** emergence.

Seal retaining channel – The steel channel into which the seal is glued.

Seam – Fore-and-aft joint of shell plating, deck and tank top plating, or a lengthwise edge joint of any plating.

Seaman – A person serving on a merchant ship except the master.

Search and rescue (SAR) boat – All-weather search & rescue craft used to help ships and people in distress.

Search and rescue radar transponder (SART) – A portable transmitter designed for survivor location during search and rescue operations. Fitting a SART enables a survival craft to show up on a search vessel radar display as an easily recognized series of dots.

Search and rescue vessel HERMANN MARWEDE

The German Sea Rescue Service (DGzRS) decided to have a new rescue vessel in 2000. It took three years to bring this new project to fruition, and 27-knot HERMANN MARWEDE



was delivered in 2003. With a length of 45.6m, a beam of 10.6m and displacement of 400 tonnes, this new rescue cruiser is the largest in DGzRS fleet. There are two engine rooms, with two 2040kW MTU 12V 4000 M90 wing engines in the forward compartment and a 2720kW 16V 4000 M90 centreline diesel aft. Each of the three engines drives a fixed pitch propeller through Reintjes gearing.

In November 2000, Fassmer won the contract to build this rescue vessel. The hull shape was optimized at the Hamburg Ship Model Basin. The aluminium hull was designed and built in Poland in Gdańsk-based Aluship Technology.



Search pattern

Even under extremely heavy seas, the vessel can maintain a speed of up to 25 knots. The equipment on board includes a powerful towing winch and a towing hook plus a 20-tonne deck crane. In the stern of the hull, there is a 9.5m 18-knot daughter boat built by Luerssen. This daughter boat is located in a slipway, which is unfolded when the hinged stern is lowered. Rescue zones have been established on each side of the vessel. A small Avon RIB is also installed.

Extensive Fi-Fi systems are installed with twin remote-controlled monitors behind the wheelhouse. They have a 41,667-litre/minute capacity and there is a third monitor on the wheelhouse top. The main fire-fighting pump is driven from one of the main engines. There is a helicopter deck at the stern above the daughter boat installation. The hull is protected by a special polyurethane fender system developed by Fassmer.

There is accommodation for a crew of eight in single cabins. On the main deck, there is a large survivor space that can also be used for extra special staff or for training. This deck also has the fully-fitted hospital equipped with an operating theatre.

Search pattern – A pattern according to which vessels and/or aircraft may conduct a co-ordinated search.

Search speed – The speed of searching vessels directed by the **on-scene commander** or **co-ordinator surface search**.

Seat – The structural support for an item of machinery or equipment.

Seaworthiness – The ability of a ship to operate in all types of weather and sea states.

Seaworthy – A term used to describe a ship which has adequate strength, **freeboard** and **stability** in order to carry and deliver its **cargo** in good condition.

Second Assistant Engineer – The licensed member of the engine department, in charge of twelve to four watch. On steam vessels he usually is responsible for boilers, on diesels, the evaporators and the auxiliary equipment.

Second Mate – The licensed member of the deck department, in charge twelve to four watch. A ship navigation officer. He keeps charts up to date and monitors navigation equipment on **bridge**.

Secondary barrier, secondary membrane – The liquid-resisting outer element of a cargo containment system designed to ensure temporary containment of any envisaged leakage of liquid cargo through the **primary barrier** and to prevent the lowering of the temperature of the ship structure to an unsafe level. See also **Membrane containment system**.

Secondary coolant – A liquid used for the transmission of heat, without a change of its state.

Secondary refrigerant – A liquid or gas which is first cooled in the evaporator of a refrigeration system and then circulated through the refrigerated space.

Section board – A grouping of electrical services which are fed from the main **switchboard**.

Section modulus – The ratio of the second moment of area to the distance measured from the neutral axis to the extreme edge of the section, e.g. the deck or bottom plating of a ship.

SECU (Stora Enso Cargo Unit) – The 90t, 13.6m x 3.4m x 3.4m covered cassette of 157 m³, maximum capacity accepted by the Swedish Railway, used for the transport of forest products from Scandinavia to North Europe.

Security incident – Any suspicious act or circumstance threatening the security of a ship.

Security level – An action level established by an Administration or Contracting Government that represents their assesment of the likelihood that a security incident will be attempted or will occur.

Security lighting system – An early warning detection system that prevents would-be intruders from boarding a vessel undetected. The system includes deck-mounted floodlights in combination with bridge wing searchlights. The deck floodlights illuminate the freeboard area of the vessel and are used during cargo operations. The bridge wing searchlights can cover areas of up to four miles and allow the crew to spot potential threats long before they reach the vessel.

Useful website: www.norselight.com

Sediment, sludge – Solids separated from a liquid.

Segregated ballast tanks – Tanks which are completely separated from the cargo oil and fuel oil systems and which are permanently applied for the carriage of ballast or cargo other than oil or noxious substances.

Segregation of goods – Separation of goods which for different reasons must not be stowed together.

Seine – A seine is a large fishing net that hangs vertically in the water by attaching weights along the bottom edge and floats along the top. A common type of seine is a purse seine, named such because along the bottom are a number of rings. A rope passes through all the rings, and when pulled, draws the rings close to one another, preventing the fish from “sounding”, or swimming down to escape the net. This operation is similar to a traditional style purse, which has a drawstring.

Seiner – Fishing boat for purse seining. See also **Purse seiner**.

Seiner/trawler – An innovative fishing vessel equipped for multi-fishing methods characterised by relative low fuel costs due to the low power trawling requirements.

Seiner/trawler TUNIS VAN LUUT UK-224

According to **HSB International** September 1998

Built by Maaskant Shipyards, The Netherlands, TUNIS VAN LUUT UK-224 is the first Dutch fishing vessel equipped for multi-fishing methods and fitted with a unique fish processing plant featuring flo-ice as the precooling system. The double-deck seiner/trawler is fitted out for seining, pair trawling and pelagic fishing methods. Seining is an adapted method of the Snurrevaad fishing method. In pair trawling, two trawl nets are towed along each other by three fishing winches mounted to two trawl boards and a contracentre weight. The closed forecabin accommodates a very special rinsing drum for efficient processing of round fish. After the rinsing, the fish is discharged to a chute filled up with flo-ice. Two seining winches are situated below deck. Each winch carries 4000m of 44 mm diameter steel cable. The three trawling winches are situated on the working deck aft next to the wheelhouse. The trawl winches can each carry 1000m of 22 mm diameter steel cable.

Length, oa: 33.55m, Length, bp: 28.88m, Beam: 7.50m, Draught: 4.20m, Gross tonnage: 331t.

Seismic Ship OCEANIC VEGA

Claimed to be the largest, purpose-built seismic vessel worldwide, the OCEANIC VEGA was delivered on 2nd July 2010 by Ulstein Verft. A powerful seismic research vessel with an overall length of 106.5m and moulded breadth of 28m, has a towing force of 140t during seismic operations and is designed to facilitate large 3D, 4D or high-resolution projects. The vessel can utilise a current streamer configuration of up to 16 streamers separated by 100m or more.

The vessel's 20 streamer winches are each capable of spooling 9km of the 5 mile-long neutrally buoyant devices that contain the hydrophones that detect the energy reflected



Photo courtesy of Ulstein Group/Tony Hall

X-Bow Seismic Research Vessel OCEANIC VEGA

from the beneath the seafloor. The seismic instrument room is located far aft on the top deck overlooking the seismic area and providing a clear view of the streamer deck. The vessel is also equipped with a spread of streamer winches, towing points and gun winches.

A storage area above the instrument room is served by a gantry crane with a 2x7.5t capacity. Two knuckle jib-type deck cranes with SWL 15t at 18m are placed amidships and serve the storage and provision rooms. Two large paravanes are launched and retrieved by two offshore cranes with operator cabins. Two seismic workboats will be used for maintenance of in-water equipment.

Propulsion is based on a diesel-electric configuration with four 12-cylinder Wärtsilä 26 generator sets, each delivering 3745kWe at 900 rev/min, and two 6-cylinder Wärtsilä 26 gensets rated at 1870kWe are divided into two separate machinery rooms to provide the full redundancy. Two 3000kWe variable speed electric motors, working in tandem configuration, each drive a nozzled, 4200mm diameter CP propeller. This provides smooth speed control of around 5 knots during seismic acquisition, a maximum transit speed of 18.2 knots and a bollard pull of 190t.

One 1200kW CP bow tunnel thruster and a single 830kW CP stern thruster aft provides additional manoeuvrability. For improved comfort, the vessel is fitted with two roll reduction tanks.

Length oa: 106.5m, Length bp: 99.3m, Breadth: 24.0/28.0m, Depth to main deck: 10.0m, Draught design/scantling: 7.0m/8.0m, Deadweight max: 6013dwt, Accommodation: 70 people.

SEISMIC SHIPS

Seismic surveys to locate subsea oil and gas bearing geological formation are carried out by seismic survey ships. The seismic ship periodically emits a percussive signal from an airgun array, which is reflected from subsea formations. The returning signals are picked up by arrays of hydrophones and the signals are either analysed on board or stored for subsequent analysis ashore.



Photo courtesy of Skipsteknisk AS

GEO CELTIC

LOA = 100.8m, Bmld = 24.0/28.0m, D = 9.60m, 71 berths

The vessel has 12 streamer winches aft on a 28m-wide cable deck and is capable of deploying 12 streamers of up to eight km in length. All winches onboard have advanced AC drive, not hydraulic, to minimise oil pollution. In addition the vessel has solid Sercel streamers.

These hydrophones are fitted in streamer cables which typically comprise lengths of flexible plastic tubing joined end to end by special connectors, filled with a mineral oil to give neutral buoyancy. Each streamer consists of 100-meter sections comprising data-transmission lines, hydrophones (specially designed microphones for receiving the seismic reflection signal), electronic modules (called bubbles) that sample, digitize, filter, and transmit the data to the onboard data-processing system, and a lead-in that connects the streamer to the boat. In addition, several pieces of equipment are attached to the streamers to control their depth and separation and to monitor their positions.

The vessel tows a series of these streamers; larger vessels operate with up to twelve streamers at once and some are capable of handling up to twenty. Vanes are used to spread the streamers so that they trail at a set separation, altogether covering an area of several square kilometres.



Photo courtesy of Hijos de J Barreras

WG COLUMBUS – first seismic ship with Ulstein's X-Bow
LOA = 88.8m, Bmld = 19.0m, D = 8.0m, 69 berths

Seismic equipment includes 12 streamer winches, 8 gun winches, 6 flexible source arrays, 3 electro compressors, 6 streamer storage winches, one head current meter, 3 echo sounders of 12, 18 and 200kHz, 2 workboats for seismic operations, one hydraulic station for seismic equipment.

Each energy source is made up of many different sizes of airguns fed with high-pressure air from air compressors. The compressors are capable of recharging the airguns rapidly and continuously, enabling firing every ten seconds for periods of up to 12 hours. In association with the streamers and source arrays is the towing equipment and positioning equipment.

See also **RAMFORM TITAN**

Selective Catalytic Reduction (SCR) – The Selective Catalytic Reduction system reduces the level of nitrogen oxide in the exhaust gas from the engine by means of catalyst elements and a reducing agent. In the process a reducing agent of an urea water solution is added to the exhaust gas stream. The water in the urea solution is evaporated as the solution is injected into the hot exhaust gas. The high temperature also induces thermal decomposition of the urea ((NH₂)₂CO) into ammonia (NH₃) and carbon dioxide (CO₂). Exhaust gas NO_x emissions are thereafter transformed into molecular nitrogen (N₂) and water (H₂O), as they react with the ammonia at a catalytic surface.

The catalytic elements are located inside a metallic reactor structure located in the exhaust gas line. The end products of the reaction are pure nitrogen and water, i.e. major constituents of ambient air. No liquid or solid by-products are produced.

The efficiency of the catalytic reduction depends on a number of factors, including the dosage of the reducing agent, the volume of catalyst elements and the exhaust gas temperature. Normally, a NO_x reduction level of 90% can be reached.

Self-polishing anti-fouling paint – A paint coating which is designed to wear down smoothly while maintaining a bio-active interface between the coating and water. The coating thus provides protection against marine growth whilst minimizing hull resistance.

Self-supporting tank – A tank used for the carriage of liquefied gas. It is strong enough by virtue of its construction to accept any loads imposed on it by the cargo.

Self-trimming – A cargo hold with a large hatch to enable the loading of loose bulk cargoes and directing it into all parts of the hold.

Self-unloading system of the HAI WANG XING

According to **The Motor Ship** September 1995

The self-unloading collier HAI WANG XING was built by Bremer Vulkan Verft, Germany, in 1995. Cargo is carried in five holds within a double-hull. The hold bottom is W-shaped, forming slopping hoppers above the two hold conveyors.

The cargo handling equipment consists of 6 conveyor belts. Unloading is accomplished via gravity through hydraulically-operated gates fitted to outlet hoppers in the bottom of each hold, releasing cargo onto two 169m long longitudinal conveyors. Each of them has a maximum capacity of 1750 tonnes/hr; the belt has a width of 2m and runs at a speed of 2.6 m/sec. These transport the cargo aft and incline up through the engine room area. There, it is transferred to two cross conveyors in the stern of the vessel. These have a belt width of 1.8m, a length of 6.6m and lift the cargo 1.4m at a speed of 2.1 m/sec. The cargo is then transferred to a single 36.6m-long centre-line inclined conveyor. It takes the cargo 10.8m upwards through the accommodation block at a speed of 3.8 m/sec out to the weather deck. Cargo is finally discharged ashore via a boom-conveyor, able to be slewed and hoisted, at a rate of about 3500 tonnes/hr. The boom-conveyor is 76.2m long, with a belt width of 1.8m and speed of 4.1 m/sec.

Self-unloading systems – Horizontal and vertical conveyor systems used to discharge bulk cargoes. Originally developed to allow ships to handle cargoes at ports not equipped with their own gear, they are also used to reduce handling costs by minimising the need for stevedores.

Bulklift system – The environmentally-friendly system which can be used to discharge most types of bulk cargoes with the hatches closed. Each hold is provided with a bucket elevator mounted on a moveable gantry. Cargo is discharged from the top and delivered to a conveyor system under the trunk deck from where it is delivered ashore through an elevator and slewing boom conveyor. A maximum discharge rate of 750 tonnes/h is possible and can be achieved with the ship at **list** of 2.5deg and with a **trim** of 1.5deg. The Bulklift system has its own diesel generator and is therefore independent of ship or shoreside power supplies.

Cargo Scooper system – The system developed by Kvaerner. Cargo Scoopers are particularly suited for small vessels and use scrapers on the surface of the cargo to feed a system of conveyors and elevators. Cargo handling can be carried out with the hatches closed, which means that there are no delays because of bad weather.

Consilium system – The gravity-fed, continuous belt type capable of discharge rates of up to 4500 tonnes/h or 100,000 tonnes/d, a rate far in excess of other conventional unloading systems. The cargo holds are V-shaped and cargo is fed by gravity from each hold onto three conveyor belts running beneath them. The cargo is then elevated from the tunnel area to the main deck level by an inward loading, vertical pocket-belt



Photo courtesy of MacGREGOR

Gravity-type self unloader system on the 28,400dwt STONES

system onto an articulated unloading boom. The double-articulated boom and specially strengthened bucket tower is an essential feature of the system.

SELSTAIR – The access system for oil platforms and other offshore installations that enables personnel to reach operational and accommodation spaces safely from the sea level. The system has been launched by the Norwegian specialist Selantic Safety AS. It comprises a foldable and retractable staircase (hoisted by motor and cable drum) which is stored on board the platform when not in use. The upper interface section may be either a swinging davit, a fixed frame for vertical launch/hoist, or a derrick crane working as a drawbridge. The staircase itself is a spiral foldable ladder with aluminium steps encircled by a Kevlar net for safety.

Semi-automatic welding – Manual welding with equipment that automatically controls welding conditions.

Semi-refrigerated gas carrier NORGAS ORINDA

According to **The Motor Ship** December 2002 and **Significant Ships** of 2002

Delivered by Hudong-Zhonghua Shipyard in 2002, the NORGAS ORINDA is the innovative and highly efficient gas carrier. Within a double-skin hull, there are only two cargo tanks, as opposed to the more common arrangement of four to six tanks found on similar ships. Their cylindrical shape with spherical ends offering 30% less surface area than bi-lobe design.

Sub-supplier of the gas plant, Tractebel Gas Engineering developed an installation in which IMO tank pressure has been increased from 4.5bar to 7bar and, together with the maximum cooling capacity, quoted as 2°C/day in tropical waters, loading time for ambient propylene at 25°C has been cut by two/three days, whilst between 4 and 10 days can be saved when cooling a cargo from 25°C to -46°C.

A cylindrical 90m³ cryogenic tank is installed on the upper deck for the carriage of coolant, with a vaporising system enabling a quick “gassing-up” process. The super cooling facilities allow the ship to carry fully-refrigerated ethylene at –104°C, which is the most significant cargo followed by LPG and other gases such as propylene, propane, butane and ammonia. Cargo processing equipment is automated, and controlled from the **bridge**, along with ballasting and operation of the main engine.

NORGAS ORINDA is fitted with a main engine, developing 6300kW and driving a highly-skewed four-bladed CP propeller through a Renk gearbox which has a power take-off for a 1700kW alternator. The arrangement is designed to operate in reverse – as a power take-in to provide propulsion in an emergency. Additional electrical supply is derived from four D2824 LE diesels each linked, to a 600kW generator.

With the emphasis on fast port turnarounds, the vessel is provided with the high-efficiency flap rudder and a 700kW CPP bow thruster. This enables the vessel to track sideways and turn within its own length. Additionally, the vessel is fitted with an efficient and quick mooring system.

Length, oa: 124.90m, Length, bp: 115.00m, Breadth, mld: 19.80m, Depth to main deck: 11.50m, Draught design/scantling: 6.70/8.30m, Lightweight: 4900t, Deadweight design/scantling: 6000/9400dwt, Service speed at 85%MCR: 16.7 knots, Total cargo tank volume: 8550m³.

Semi-submersible ships – see **Heavy lift ships**.

Sensor – A detecting device which is part of a transducer. It extracts energy from the measured medium in the process of measurement.

Separate – “Separate” means that a cargo piping system or cargo vent system, for example, is not connected to another cargo piping or cargo vent system. The separation may be achieved by the design or operational methods, (**IBC Code**).

Separation – The term is used to describe the separation of two mutually insoluble liquids, usually oil and water, while removing any solids present at the same time. Separation can be achieved by gravity or by centrifugal force. A liquid mixture in a stationary **settling tank** clears slowly as a heavier liquid and solids sink to the bottom under influence of gravity. In a rapidly rotating bowl, the force of gravity is replaced by centrifugal force which can be thousands of times greater. Separation is continuous and happens very quickly. The greater the density differences between the two liquids, the easier the separation.

Separator – The separator consists of a frame, an electric motor drive and a vertical shaft on the top of which the bowl assembly is mounted. The separator can be operated either as a **purifier** or as **clarifier**. When operated as a purifier, the separator discharges the separated water continuously. When the oil contains only small amounts of water, the separator works as a clarifier, discharging the water together with the solid particles.

Serious casualty – An accident resulting in at least one of the following consequences (LMIS, 1995):

- **Total loss.**
- Breakdown resulting in the ship being towed or requiring assistance from ashore.
- Flooding of any compartment.
- Structural, mechanical or electrical damage requiring repairs before the ship can continue trading.



Separation system modules from Alfa-Laval



Photos: C. Spigarski

Separator room

Service ships – Vessels designed to provide support to **commercial ships** and/or **industrial vessels**, such as **tugs**, **offshore support vessels**, crane barges, diving support boats, fire boats, pilot boats and buoy tenders.

Service spaces – Spaces used for galleys, pantries containing cooking appliances, lockers, mail and specie rooms, store-rooms, workshops other than those forming part of the **machinery spaces** and similar spaces and trunks to such spaces, (**SOLAS**).

Service tank, daily service tank – A tank supplying clean, treated fuel oil directly to the engine. See **Fuel oil service tank**.

Settling tank – A deep tank in the engine room used for pre-cleaning of fuel oils by gravity; a liquid mixture in the settling tank clears slowly as a heavier liquid and solids sink to the bottom under influence of gravity.

Usually there are two settling tanks, each with a capacity sufficient for 24 hours full load operation of all consumers. Tanks should be designed to provide the most efficient sludge and water separation. Each settling tank should be provided with baffles to reduce mixing of sludge with the fuel. The bottom of the tank should be with slope toward the sludge drains, and pump suction shall be not in the vicinity of the sludge space. The temperature in fuel settling tanks should be as high as possible to help the dirt to settle. However, the temperature should be below 75°C in order to avoid the formation of asphaltenes, and min 7°C above the **pour point** of the fuel to ensure pumpability.

Sewage – Drainage and other wastes from any form of toilets, urinals, and WC scuppers, drainage from medical premises (dispensary, sick bay, etc.) via wash basins, wash tubs and scuppers located in such premises, (**MARPOL**).

Sewage treatment, waste management – There are three main sewage treatment processes: biological, physico-chemical and electrocatalytic oxidation. See also **Membrane BioReactor**.

Physical-chemical treatment of sewage

Physical-chemical treatment of sewage is based on the separation of the liquid element from the sewage flow by bathing it in chlorine for thirty minutes to kill off coliform bacteria before discharging it overboard. Usually treatment units using this type of process are designed to hold only a fourteen-day accumulation of solids, then discharge to port sewage reception facilities or outside territorial waters.

Electrocatalytic oxidation

This type of treatment plant collects the sewage and directs it through a macerator which breaks it down into minute particles. Then, the sewage passes through an electrolytic cell where the oxidation process takes place. Next, the effluent flows under its own pressure to a settling tank for completion of oxidation process and direct discharge overboard. The discharge contains no solids and is totally free of coliform bacteria.

Further reading: Guidelines on implementation of effluent standards and performance tests for sewage treatment plants Resolution MEPC 159 (55)

Shackle – U-shaped steel forging with a pin through an eye on each leg of the U.

Shaft – A circular section rod or bar which transmits rotary motion, e.g. **propeller shaft**.

Oil distribution shaft – A hollow propulsion shaft where the bore and radial holes are used for distribution of hydraulic oil in controllable pitch **propeller** installations.



Photo courtesy of Wärtsilä Corporation

Wärtsilä Hamworthy Super Trident ST-C sewage treatment plant

Wärtsilä Hamworthy is the world's leading manufacturer of marine sewage treatment plant. For over three decades Super Trident sewage treatment plant have been widely regarded as standard specification on all vessels. Plant installed on existing ships on or after 1 January 2010 and on new ships whose keels are laid on or after this date must meet the new IMO MEPC 159(55) guidelines, which are more stringent than the longstanding IMO MEPC 2(VI) guidelines. The STA-C and ST-C series of Wärtsilä Hamworthy plant is certified to meet IMO MEPC 159(55). An STA-C or ST-C unit is fully compatible with gravity and vacuum collection systems, and uses the activated sludge system, which accelerates natural biological processes. Chemical disinfection and dechlorination are employed to produce a clean, safe, effluent suitable for discharging at sea.



Photo: C. Spigarski

Shaft

Propeller shaft, tail shaft – A short shaft passing through the stern tube with a tapered outer end on to which the propeller is locked.

Thrust shaft – A thrust shaft is a part of the propulsion shaft which transmits thrust to the thrust bearing.

Shaft alignment – A static condition observed at the bearings supporting the propulsion shafts. It is calculated, conducted and verified when the system is at rest. A good static alignment is required for trouble-free dynamic operation of the propulsion shafting. The objective is that the alignment remains acceptable for vessel loading variation as well as temperature variation affecting the shafting system.

The basic procedure for determining vertical alignment of shafting and gears is to calculate, for the cold condition at time of aligning, a shape of shaft line that will produce in the hot operating condition essentially equal loads on the main gear bearings and reasonably equal loads on line bearing. Two methods used for establishing the desired alignment are the **gap and sag method** and the **bearing load measurement method**. The alignment is checked during installation by a taut wire, a sighting telescope or a laser beam.

Further reading: *ABS Publication "Guidance Notes on Propulsion Shafting Alignment" (2004), can be downloaded from www.eagle.org*

Alignment procedure – An executable part of the alignment process where alignment is performed in accordance with the defined requirements.

Alignment process – Alignment process consists of the design and analysis, the alignment procedure and measurements.

Bearing clearance – Radial gap between the shaft and the bearing shell.

Bearing offset – Vertical displacement of the contact face of the bearing from the optically- established central line of the shafting.

Gap and sag method – The procedure of verification of the alignment condition prior to shafting assembly. Sag and gap is verified between mating flanges and has to comply with the appropriate, analytically obtained, values. Sag and gap procedure should be conducted in the dry dock. If sag and gap is conducted on a waterborne vessel, then the accuracy of analysis may be in question, as the hull deflection effect needs to be considered. The yard should be able to fully control the alignment.

Bearing load measurement method – In this method, the desired bearings loads are obtained directly by measuring the actual bearing reactions.

Jack-up method – Jack-up method is a direct way to check bearing reactions. Measurements are conducted by hydraulic jacks which are placed in close proximity to the bearing of which reaction is to be measured. It is strongly recommended to use hydraulic jacks in combination with the load cell, as the measurement accuracy will significantly improve.

Shaft alignment sighting, sighting through – The process of establishing the reference line. The major welding work should be completed on the stern block of the vessel to prevent structural deformation which may result from excessive welding. The temperature of the vessel structure must be stable and as even as possible. For that reason, the operation is done at night to minimize the distortion of the hull due to diurnal temperature effects.

Shaft alternator

Shaft alternator – An alternator driven by the main engine to supply power to the mains. The shaft alternator can be arranged in a number of different ways. The appropriate configuration for medium-speed main engines is the drive of the shaft alternator by power take off (PTO) of the reduction gear. In case of low-speed main engine, the poles of the shaft alternator are mounted directly on the shaft which is designed in the poles area with an enlarged diameter. This configuration with a large air gap of 7.5mm between the stator and rotor, is the most widely used assembly.

On ships with fixed pitch propeller, torque respective power is set via the propeller speed. If using CP propeller shaft speed and propeller pitch are adjusted simultaneously in order to achieve the optimum propeller efficiency in so-called combinator mode.

The classical shaft alternator systems consist of a shaft alternator for active power generation, a synchronous compensator for reactive power and short circuit current generation, a frequency converter with rectifier, DC intermediate circuit and line-controlled thyristor inverter.

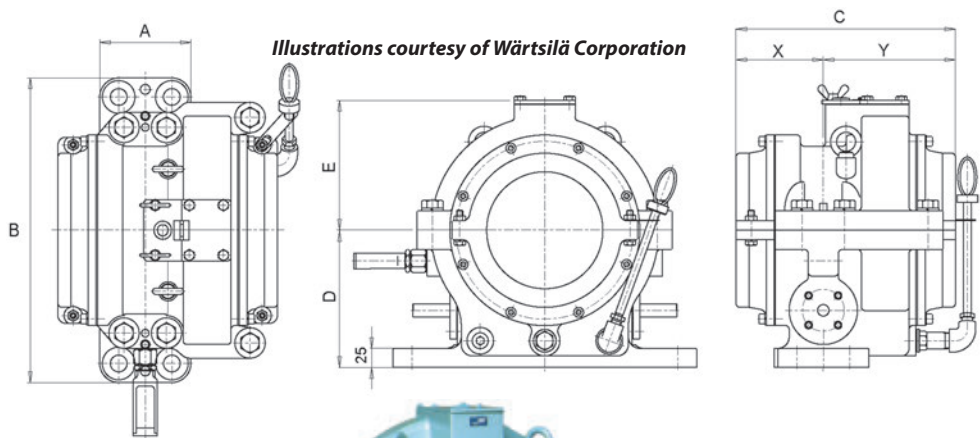

Intermediate shaft bearing

Shaft bearings – Bearings which support the intermediate shafting between the tailshaft and the main engine or gearbox. In general, sleeve bearings are used. The shaft is supported by a lubricating film in a bearing that is usually lined with white metal.

Shaft coupling – A connection between two lengths of the propeller shafting. Most shafts are connected to each other by means of forged flanges. Muff couplings and removable flanges are alternatives.

Shaft earthing device – A turning propeller is electrically insulated from the hull by the lubricating oil film in the bearings. Electrical potential is generated between the shaft and the hull. As a result the cathodic protection of the ship will not protect the propeller. Electrical potential can cause currents in the bearings resulting in pitting of the bearing surfaces. Problems can be avoided if the shaft is earthed with a propeller shaft slip ring. This shaft earthing assembly comprises a pair of high silver content/graphite compound brushes mounted in a balanced brush holder, running on a copper slip ring with solid silver track.



Shaft earthing device

Figure courtesy of Wärtsilä Corporation

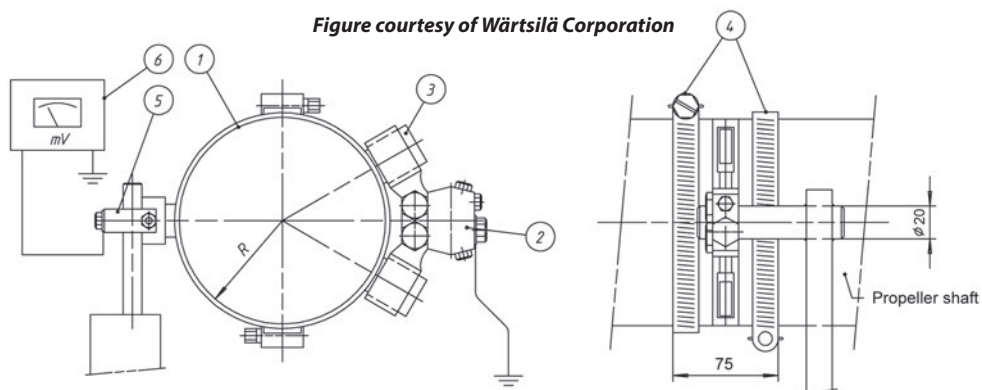

- | | |
|---------------------------|-------------------------------------|
| 1. Silver/copper slipring | 4. Stainless steel badclamp |
| 2. Brushholder assembly | 5. Monitoring brushholder assembly |
| 3. Earthingbrush | 6. Shaft earthing potential monitor |

Shaft tunnel – A watertight enclosure for the propeller shafting large enough to walk in. It extends aft from the engine room to provide access and protection to the shafting in the way of holds.

Shafting – Shafts and associated components used for transmission of power.

The main propulsion shafting system consists of shaft sections connected by means of bolted flange couplings and supported by bearings that maintain the shafting in proper alignment.

Intermediate shafting – Lengths of shafting between a power source and a propeller shaft.

Line shafting – The shafting located inside the ship.

Wet shafting – The shafting located outside the ship.

Shale gas – Shale gas is defined as natural gas from shale formations. The shale acts as both the source and the reservoir for the natural gas. Older shale gas wells were vertical while more recent wells are primarily horizontal and need artificial stimulation.

Shark jaws – Remotely controlled chain and wire stoppers used onboard **AHTS** to unshackle lengths of wire on deck when carrying a loaded wire over the stern roller. It comprises a hydraulically-operated cylindrical unit which can be retracted flush with the working deck for stowage or raised to a working position. In the working position, the wire or chain is supported clear of the deck. The cylindrical unit is forked at the top and contains a pair of hydraulically-operated jaws. Two sets of jaws can be interchanged quickly; one for wire, the other for chain. The wire slides between the open jaws, the jaws are closed and the winch eases off the strain allowing the splice on the wire to be pulled against the jaws, thus enabling the buoy to be safely unshackled.

Shear force – A force tending to cause displacement of a transverse plane due to unequal loading. The distribution of load along a ship and the **buoyancy** are unequal at various points and cause such shear forces to exist.

Shear stress – The **shear force** intensity per unit area of cross section, which varies across the section. It is a consideration in the structural strength of ships which are subjected to longitudinal bending.

Sheath – A covering fitted over the insulation of an electric cable to protect against heat, oil and chemicals. It must also be tough and flexible.

Shedder plate – A section of inclined plating welded to a bulkhead within a cargo hold, commonly in way of corrugations to facilitate the flow of granular material, at the same time providing additional rigidity to the **bulkhead**.

Sheer – The longitudinal curve of the vessel decks in a vertical plane, the usual reference being to the ship side; in the case of a deck having camber, its centreline sheer may also be given in offsets. Due to the sheer, a vessel deck height above the baseline is higher at the ends than amidships.

Sheer strake – The top strake of a ship side shell plating.

Sheerleg – A type of the floating crane.

The sheerleg TAKLIFT 10 has a length of 96 m and a breadth of 41.5m. The lifting system consists of an A-frame with a length of 72m and capacity of 3000t at a height of 65m. A 40m flyjib, which protrudes from the A-frame, offers the additional lifting capacity of 1600t at a height of 105m.

Shell door – Doors in the side shell can be seen on almost every type of ship and are used for various duties. The most common ones are for passengers, pilot entry, and for bunker hoses. The opening mechanism can be either sliding, top-hinged or side-hinged.

Shell expansion – A plan showing the seams and butts, thickness and associated welding of all plates comprising the shell plating, framing, etc.

Shell plating – The plates forming the outer side and bottom skin of the hull. The shell plating is of crucial importance to the longitudinal strength of the ship structure.

Shelter deck – A continuous deck above the **freeboard deck**.

SHERLOG – The MacGREGOR Sherlog is a type-approved, ultrasonic testing system for verification of tightness of hatch covers, doors, ramps and windows. Sherlog equipment can also be used to test bulkheads or any openings on board which need to be sealed. It consists of two parts: an ultrasound multi-transmitter and a hand-held detector. The multi-transmitter is placed in the hold in the central position. It produces a uniformly-

distributed omni-directional sound field throughout the hold space. The hand-held detector measures the sound energy. The transmitter sound is produced in a narrow frequency band and the detector is tuned to filter out just this band. Thus the inspector, wearing a headphone and reading a digital display, is not hampered by surrounding noise and can positively detect any leak greater than 0 dB.

Shielded metal arc welding (SMAW) – An arc welding process with an arc between a covered electrode and the weld pool. The process is used with shielding coming from the decomposition of the electrode covering, without the application of pressure, and with the filler metal from the electrode.

Shielding gas – Protective gas used to prevent or reduce atmospheric contamination.

Shifting boards – Wooden planks which are used to partition holds to prevent the movement of loose bulk cargoes. They are fitted fore and aft on the centreline in the way of hatches.

Shifting cargoes, shifting loads, also sliding loads – Granular cargoes that adversely affect the stability. During roll, the granular material, such as grain, coal, etc., stays in place until the heel angle exceeds the **angle of repose**. Then, the granular load slides suddenly resulting in stability reduction.

Shim – A thin strip of metal which is used to adjust the clearance between mating parts, e.g. the two halves of a big end bearing.

Ship – A sea-going or coastal vessel which is not propelled by oars.

Ship design process

The development of a new ship design is carried out in three steps.

The first one is the **Basic Design** with aim to create a baseline concept of the new vessel that satisfies the shipowner's requirements. At this step, the Preliminary General Arrangement Plan and a short description of the vessel are prepared.

In order to carry out the Basic Design it is necessary to define the following items:

1. Types of cargo intended for transport
2. Requested cargo capacity
3. Restrictions for main dimensions if any
4. Required service speed
5. Endurance
6. Class Society and ship class
7. Required number of cabins
8. Cargo handling equipment
9. Type of hatch covers
10. Other requirements.

The second step is the Contract Design with the aim to develop detailed contract plans and specifications necessary to calculate the price of the vessel and to sign the Contract with a shipyard. Usually the scope of the Contract Design for a container vessel is as follows:

	Document
1	Specification
2	General Arrangement Plan
3	Tank Plan
4	Plan of containers

5	Calculation of Equipment Number
6	Preliminary Midship Section
7	Estimation of Lightweight and Center of Gravity
8	Longitudinal Distribution of Lightweight
9	Engine Room Layout
10	Arrangement of the Emergency Genset Room
11	Preliminary Heat Calculation for cooling
12	Preliminary Electric Balance
13	Diagrams of main systems
14	List of the Engine Room Machinery
15	Hull Lines
16	Offset Tables
17	Hydrostatic Tables
18	Freeboard Calculation
19	Speed/Power Predictions
20	Calculation of intact stability and bending moments
21	Calculation of damage stability
22	Makers List

After signing the contract with a shipyard, it is possible to carry out the Technical Design which contains all drawings, documents and calculations to be approved by a **class society, national authority** and shipowner.

Ship elevator – A ship lifting system. The ship elevator includes a number of hydraulic lift/lower chain jack stations on each side of the elevator platform. Vessels are built and transferred from in-shore construction berths by three-way skid transfer system.

Ship identification number, IMO number – Passenger ships of 100 gt and above and cargo ships of 300 gt and above are to have an identification number (IMO number) which is to be shown on the statutory certificates. This number remains with the ship throughout its life regardless of any changes of name, flag, or classification.

Ship model basins – Hydrodynamic test centres equipped with **model testing tanks** and propulsor testing facilities to perform experiments on hull and propulsor design. These cover all questions arising in the process of the ship design such as: calm water resistance, propulsion prediction, hullform design and optimisation, seakeeping and manoeuvring predictions as well as propeller analysis and cavitation. See also **HSVA, MARIN, HYKAT**.

Ship motions – A ship at sea moves in six degrees of motion: heave, sway, surge, roll, pitch and yaw. The first three are linear motions. Heaving is the linear motion along the vertical Z-axis, swaying is the motion along the transverse Y-axis, and surging is the motion along the longitudinal X-axis. Rolling is a rotation around a longitudinal axis, pitching is a rotation around the transverse axis and yawing is a rotation around the vertical axis.

Ship resistance – The motion of a ship through water requires energy to overcome resistance, i.e. the force working against movement. As the resistance of a full-scale ship cannot be measured directly the knowledge about the resistance of ships comes from model tests. The total resistance on calm water can be divided into three main components: frictional resistance, residual resistance and air resistance.

The frictional resistance depends on the size of the wetted area. It represents often about 70-90% of the ship total resistance for low-speed ships (bulk carriers and tankers), and sometimes less than 40% for high-speed ships (containers and passenger ships).

Residual resistance comprises wave resistance that refers to the energy loss caused by waves created by the vessel and viscous pressure resistance. This residual resistance normally represents 10-25% of the total resistance for low-speed ships and up to 40-60% for high-speed ships. Air resistance normally represents about 2% of the total resistance, however, for loaded container ships in head wind, the air resistance can be as much as 10%.

During the operation of ship, the paint film on the hull breaks down. Erosion starts, and marine plants and barnacles, etc. grow on the surface of the hull. In addition, the propeller surface can become rough and fouled. The total resistance caused by fouling may increase by 25-50% throughout the lifetime of a ship.

Resistance also increases because of sea, wind and current. The resistance when navigating in head-sea could perhaps increase by as much as 50-100% of the total ship resistance in calm weather.

Ship Security Officer (SSO) – The specific individual onboard the ship who is designated by the Company. The SSO reports to the Master for the overall management and oversight of all shipboard security policies, programs and procedures. The SSO is identified by name and position on the ship crew list and in the advance notice of arrival.

Ship Structure Access Manual – A manual describing means of access to carry out overall and close-up inspections and thickness measurements. Required for oil tankers of 500 gross tonnage and over, and bulk carriers of 20,000 gross tonnage and over, constructed on or after 1 January 2006. The SSAM shall be approved by the **Administration**, and an updated copy shall be kept on board.

Further reading: Resolution MSC.194(80)

Ship types – Depending on their mission, ships can be divided into different categories: **naval vessels**, **commercial** (merchant) **vessels** transporting cargo or/and passengers, **industrial vessels** performing specialized marine functions such as fishing, drilling, cable or pipe laying, **service vessels** providing support to commercial ships and/or industrial vessels. An increasing occurrence of multi-purpose ships and development of novel types of ships makes them difficult to categorize.

Shipboard incineration – The incineration of **wastes** or other matter on board a ship, if such wastes or other matter have been generated during normal operation of that ship.

Shipboard incineration of sewage sludge and sludge oil may also take place in the main or auxiliary power plant or boilers, but in those cases, shall not take place inside ports, harbours and estuaries.

Shipboard incinerator – A shipboard facility designed for the incineration of wastes or other matter on board, generated during the normal operation of the ship. Incinerators are predominantly designed for intermittent operation, hand fired and fed by hand. The ash or vapor can be hazardous.

Regulation 16 of MARPOL Annex VI requires that all shipboard incinerators installed on ships on or after 1st January 2000 are type approved by the Administration based on the requirements contained in IMO Resolution MEPC 76(40).

Further reading: ABS Guide to Shipowners – Understanding MARPOL Annex VI (can be found on www.eagle.org)

Shipboard Marine Pollution Emergency Plan (SMPEP) – Regulation 26 of Annex I of MARPOL requires every oil tanker of 150 gt and above and every ship other than an oil tanker of 400 gt and above to carry a **Shipboard Oil Pollution Emergency Plan (SOPEP)** approved by the Administration. Regulation 16 of Annex II of **MARPOL** requires every ship of 150gt and above that is certified to carry noxious liquid substances in bulk to carry on board a **Shipboard Marine Pollution Emergency Plan For Noxious Liquid Substances** not later than 1st January 2003. Ships to which both regulations apply may have a combined plan called a Shipboard Marine Pollution Emergency Plan, or SMPEP.

Shipboard Marine Pollution Emergency Plan For Noxious Liquid Substances – According to **MARPOL 73/78**, Annex II, reg. 16, every ship of 150 tons gross tonnage certified to carry noxious liquid substances in bulk shall carry on board a Shipboard Marine Pollution Emergency Plan For Noxious Liquid Substances approved by **Administration**.

Shipboard Oil Pollution Emergency Plan (SOPEP) – The plan consisting of procedures and descriptions of actions to be taken in the event of an oil pollution incident. According to **MARPOL 73/78**, Annex I, reg. 26, every **oil tanker** of 150 tons gross tonnage and above and every ship other than an oil tanker of 400 tons gross tonnage and above shall carry on board a Shipboard Oil Pollution Emergency Plan approved by **Administration**.

1. *The SOPEP shall be written in accordance with the requirements of regulation 26 of Annex I of the International Convention for the Prevention of Pollution from Ships, 1973 as modified by the Protocol of 1978 relating there to.*
2. *The purpose of the SOPEP is to provide guidance to the Master and officers on board the ship with respect to the steps to be taken when an oil pollution incident has occurred or is likely to occur.*
3. *The SOPEP shall contain all information and operational instructions as required by the “Guidelines for the development of the Shipboard Oil Pollution Emergency Plan” as developed by the Organization (IMO) and published under MEPC/ Circ. 256. The appendices contain names, telephone, telex numbers, etc., of all contacts referenced in the SOPEP, as well as other reference material.*
4. *The SOPEP has been approved by the Administration and, except as provided below, no alteration or revision shall be made to any part of it without the prior approval of the Administration.*
5. *Changes to non-mandatory information and the appendices will not be required to be approved by the Administration. The appendices should be maintained up to date by the owners, operators and managers.*

Shipboard technical manual – Any document that explains how to use, maintain and operate the ships and their equipment. A technical manual is an essential part of the product and its usability has considerable importance for the ship operators.

Shipboard tests – After installation on board, the machinery and the equipment is tested during **dock tests** and subsequent **sea trials** in accordance with the approved test programs. The shipboard tests are intended to demonstrate that the main and auxiliary machinery and associated systems are functioning properly.

Shipbroker – A person who, on behalf of shipowner/shipper, negotiates a deal for the transportation of cargo at an agreed price. Shipbrokers are also active when shipping companies negotiate the purchasing and selling of ships, both secondhand tonnage and newbuilding contracts.

Shipment – A quantity of goods sent by sea.

Shipowner – An owner, manager or operator having day-to-day commercial and/or operational control of the vessel.

Shipping –

1. A term relating to all aspects of marine transport.
2. The transport of goods by sea.

Ship-to-ship (STS) transfer operation – It is an operation where **crude oil** or petroleum products are transferred between seagoing ships moored alongside each other. Such an operation may take place when one ship is at anchor or when both are underway. In general, the expression includes the approach manoeuvre, berthing, mooring, hose connecting, safe procedures for cargo transfer, hose disconnecting and unmooring.

Shipyards – The place where ships are built or repaired.

Shop primer – A rust preventing paint for temporary protection of steel applied immediately after **blasting**, generally in low thickness and before welding and other fabrication.

Shore supply – Electricity supply from the shore mains when a ship is in dock undergoing repairs.

Short circuit – An electric contact between parts of an electric circuit, which causes a very high current, increases in temperature and potentially fire, if the circuit is not properly protected. This can occur if two live wires come into contact with each other, perhaps because of worn insulation. The term is also used when defining the safe operating conditions for electrical devices. If a device is said to have a short-circuit resilience of 400 amps (A), it means that it can be subjected to up to 400 A before it will shut itself down.

Short international voyage – An international voyage in the course of which a ship is not more than 200 miles from a port or place where the passengers and crew could be placed safely. Neither the distance between the last port of call in the country in which the voyage begins and the final port of destination nor the return voyage shall exceed 600 miles. The final port of destination is the last port of call in the scheduled voyage at which the ship commences its return voyage to the country in which the voyage began, (**SOLAS**, Chapter III).

Shredder – A tool or machine that is used for cutting things into very small pieces.

Dry waste is centrally collected, shredded in hydraulically-driven shredders, stored in silos and automatically fed into the incineration process.

Shrouded propeller – A **propeller** fitted within a duct or nozzle in order to improve its **efficiency**.

Shuttle tanker – A tanker intended to carry oil from shelf fields not accessible to pipeline systems. This tanker type is designed to operate in conjunction with offshore loading installations such as **submerged turret loading (STL) system**, a subsurface loading station (UKOLS), **floating storage and offloading (FSO) units**, **floating production, storage and offloading (FPSO) units**, or articulated loading platforms (ALP/SPM). The shuttle tanker is in light condition prior to docking with a loading buoy making conventional **thrusters** non effective in bad weather and heavy seas. As a result, the vessel might have to wait for several days before it could start loading, which costs time and money. To avoid such operational problems, the shuttle tanker should have good dynamic positioning capabilities: the ability to position itself while docking at a loading buoy, and its ability to maintain that position while loading.

Photos courtesy of REMONTOWA SA



Shuttle tanker with bow loading system

Shuttle tanker NAVION BRITANNIA

According to **The Motor Ship** September 1998

Delivered in 1998 by Astilleros Espanoles, the 126,650dwt vessel is a **twin-skeg**, twin screw shuttle tanker. The double-hulled ship is specially designed for offshore loading from storage facilities at a field, or directly from production platforms and loading buoys. With 18 cargo tanks, two slop tanks and ten segregated ballast tanks, NAVION BRITANNIA has also a tank configuration and loading process designed to minimise cargo vapour emissions, and avoid spillage during loading. Cargo can be loaded either through the midships manifold, or by means of a **bow loading system**. A third method employs submerged turret loading from a buoy anchored to the sea bed and connected by pipeline to the production facility. Loading and discharging rates are 8000 m³/h for the bow and turret loading system, and 12,000 m³/h through the manifold. Two segregated grades of crude oil can be handled by four Kvaerner 3000 m³/h pumps. A tank radar sounding system measures the **ullage** in the 20 tanks, and inert-gas pressures and temperatures at three levels are also recorded. Two suction/discharge lines, aluminium heating coils in the bottoms of cargo and slop tanks, two crude oil washing lines, and a 15,000 m³/h **inert gas** plant are fitted.

To meet the demanding conditions associated with offshore work, the ship is equipped with a trio of retractable, controllable pitch **thrusters** and two highly efficient **Hamworthy rudders** driven by a pair of rotary vane electro-hydraulic **steering gears**.

The two fully redundant engine rooms are divided by an A-60 fire resistant, watertight **bulkhead**. The main **switchboard** is also divided into two separate units located in each engine control room. Main propulsion is by two engines with a MCR of 11,520 kW at 123 rev/min. Each engine drives a 6 m-diameter CP propeller.

The ship is capable of acting as a well-test vessel. The foredeck has thus been strengthened to allow topsides production equipment, including a light process plant and flare stack to be installed. The vessel has **accommodation** for 55 persons, although its normal complement is 22.

Length, oa: 264.68m, Length, bp: 256.50m, Breadth, mld: 42.50m, Depth, mld, to main deck: 22.00m, Draught design/scantling: 15.00m/15.65m, Deadweight design/scantling: 118,138 dwt/124,978 dwt, Service speed: 15 knots.

Side-loading system of CALA PIANO

The 11,550dwt **reefer vessel** CALA PIANO is equipped with the twin side loading system to handle underdeck palletised cargo. Each of the two starboard side units consists of a large side door, a side platform extending out over the quay from the vertically stowed position, two platform conveyors, plus an outer-section **scissor lift** for meeting varying quay heights. Each platform, accommodating eight pallets, is served inboard by the ship fleet of forklift trucks which handle the cargo from and to every point throughout the multi-deck hold spaces. Watertight doors in the two **athwartship** bulkheads permit vehicle access throughout the underdeck spaces.

Side-loading systems – Cargo handling systems used for pallets and paper rolls. Usually a side-loading system consists of elevators and a side door. The Norwegian company TTS-Mongstad AS has developed different systems such as the system working with conveyors, the Sidemover or the Sideswinger. The side door and ramp system is the most commonly used side-loading system on coastal ships, smaller reefer ships and paper carriers. The use of the side door as a driving ramp eliminates movements of the ship relative to the quay while the forklift trucks are placing cargo on, or retrieving cargo from the elevator.

Side-loading vessels – Vessels equipped with a side-loading system are normally purpose-built for specific trade or cargo. Ship types include paper carriers, pallet carriers, reefers and shortsea/coastal multi-purpose vessels. The cargo may consist of paper rolls, pallets or other types of breakbulk cargoes.

Side plate – A part of a hatch cover; the vertical plate forming the outer edge of each panel.

Side-rolling covers of the ore carrier PEENE ORE

The **ore carrier** PEENE ORE can transport 322,000 tonnes of ore with stowage factor of 19.7 ft³/long ton. The ship has seven cargo holds with a total capacity of 175,000m³, surrounded by large port and starboard wing ballast tanks and a deep, void double bottom. The longitudinal bulkheads separating the holds from the side tanks are sloped inwards from deck to tank top.

The ship is provided with MacGREGOR rack-and-pinion and Roll-up-Roll side-rolling covers. The single-panel covers provide nominal openings 26m long x 12.32m wide (Hold N^o1) and 26m x 17.60m (Holds N^{os} 2-7). In the open position the panels stow to the starboard side on transverse ramps. When closed, the cover gets wedge-cleated and weathertight automatically.

Side support stowage system

A hydraulically-operated roll-up mechanism raises the cover into the rolling position. The rolling is effected by a rack-and-pinion system. Each panel is served by a dedicated hydraulic motor which is mounted on the coaming and engaged, via a pinion, with a rack fitted to the underside of the panel. Guidance of the panels is performed by double-flanged wheels fitted at one end. Special plain wheels at the other end allow for coaming movement.

Side support stowage system – A system to stow 20 feet containers into 40 feet cell guides.

The containers are connected in the 20 feet gap with double stacking cones in a transverse direction. The longitudinal **bulkhead** has either a guide rail or foundations for buttresses that take up the load. See also **Anti-Rack Spacer stowage system** and **Mixed stowage**.

Sideshifter, sideloader – Cargo handling equipment used on **reefer ships** and **paper carriers**. A sideshifter consists of an elevator tower with a top-hinged door and two elevator units located one at forward and one at aft end of the door aperture. Each elevator comprises a vertical column in which a wheeled carriage with attached working platform runs. See also **Side loading system of CALA PINO** and **Side loading systems**.

Sideshorings – Usually aluminium panels used to support palletized cargo in order to reduce damage. Holds of refrigerated ships carrying cargo in pallets and in bulk are fitted with sideshorings. While loading bulk cargo, the sideshorings do not have to be removed from the side of the cargo hold. While set vertically, they secure the palletized cargo during transport resulting in less damage. An innovative type of sideshoring, consisting of multi-chambered rubber bellows, has been developed and patented by the Swedish company KALLNER REEFER.

Side-thrust effect – When a ship is sailing, the **propeller** blades bite more in their lowermost position than in their uppermost position. The resulting side-thrust effect is larger the more shallow the water is (as during harbour manoeuvres). Therefore, a clockwise (looking from aft to fore) rotating propeller will tend to push the stern in the starboard direction, i.e. pushing the stem to port, during ahead running.

When reversing the propeller to astern running, the side-thrust effect is also reversed. Thus, the **pilot** has to know how the ship reacts in a given situation. It is, therefore, an unwritten law that on a ship fitted with a fixed pitch propeller the propeller is always designed for clockwise rotation when running ahead.

In order to obtain the same side-thrust on ships fitted with a controllable pitch propeller, when reversing to astern, CP propellers are normally designed for anti-clockwise rotation when sailing ahead.

Side-wall craft – An **air-cushion vehicle** whose walls extending along the sides are permanently immersed hard structures.

Siemens-Schottel Propulsor (SSP) – Podded propulsion unit developed by Siemens and Schottel. It comprises a steerable underwater unit housing a permanent magnet motor directly coupled to two propellers, one ahead of the unit, one astern of the unit turning in the same direction. The use of twin propellers is claimed to boost the efficiency by reducing the load on each individual propeller while the rotational energy from the tractor propeller is recovered as lift and forward thrust on a pair hydrofoil fins angled out from the pod.

The rotor carries permanent magnets while the stator carries the field which is fed from a pulse width modulation (PWM) system in the hull. The stator casing is shrunk into the pod and overhang of the stator windings is encapsulated in a heat conductive material



connected to the pod. This means that the heat generated in the motor is conducted to the surrounding water without any need for internal air or water cooling system.

Built at the Chinese Shanghai Edward yard, the product carrier PROSPERO was the first vessel fitted with SSP propulsor.

Simulated launching of free-fall lifeboats – Means of training the crew in the free-fall release procedure of free-fall lifeboats and in verifying the satisfactory function of the free-fall release system without allowing the lifeboat to fall into the sea.

Further reading: MSC.1/Cir.1206

Guidelines for Simulated Launching of Free-fall Lifeboats.

Single Anchor Leg Mooring (SALM) – The **single point mooring** system. A single anchor leg mooring system consists of an anchoring structure with built-in **buoyancy** at or near the water surface and is anchored to the seabed by an articulated connection.

Single bottom structure – The shell plating with stiffeners and girders below the upper turn of bilge.

Single-pull cover – A type of multi-panel **hatch cover** in which the panels roll along the coaming and tip into stowage. The panels may be driven by a chain drive or pulled by a wire.

Single-welded joint – A joint that is welded from one side only.

Siphon – An inverted U-shaped pipe with unequal legs for conveying liquid over the edge of a container and delivering it at a lower level, utilising atmospheric pressure. It requires priming before flow can commence.

Sister ship – A ship of the same main dimensions, general arrangement, capacity plan and structural design as the first ship in a series.

Skeg – A deep, vertical, finlike projection on the bottom of a vessel near the stern, installed to support the lower edge of the **rudder**, to support the **propeller shaft** for single screw ships, and to support the vessel in a **dry dock**.

The hull efficiency of the twin-skeg vessel is expected to be about 5% lower than for the single-screw vessel owing to less favourable wake field.

Skiff – A powered boat used to assist the **purse seiner**. Since purse seiners must be able to manoeuvre close to the net without fouling the propeller, most of them require the assistance of a powered skiff.

Skimmers – They are devices for removing the oil from the sea surface, and can be found in many forms. They may be free-floating, vessel mounted, or held by a crane or other means. Among the techniques commonly applied there are pumps, conveyors, hydrodynamics, weirs, discs, drums or belts, or combinations of these.

Skin friction – The resistance component of a ship which is due to the roughness of the hull plating.

Skirt of an air-cushion vehicle – A downward-extending, flexible structure used to contain or divide an air cushion.

Skylight – An opening in a deck to ensure air and light to the compartment below.

Slack tank – Any tank that is not totally empty or pressed full.

Slewing – To rotate about a vertical axis in a horizontal plane. See also **Crane motions**.

SLICE – A **SWATH** hull form variant produced by Lockheed Martin from USA. A further development of SWATH technology using four (2x2) torpedo-like submerged hulls instead of two. This further reduces the water drag.

Sling – A loop of rope or wire which is used for the hoisting of a heavy item. It may also describe a length of wire with a loop at each end.

Slip –

1. The difference between the actual distance travelled by a ship and the theoretical distance given by the product of the propeller pitch and the number of revolutions. It is usually expressed as a percentage and can have a negative value if a current or following wind exists.
2. The inclined way upon which a ship is built and then launched.

Slip (to) – To separate from by unshackling a link of chain, e.g. slip an **anchor**.

Slipway – An inclined shipbuilding berth.

Slop chute – A chute for dumping garbage overboard.

Slop tanks – Tanks in an oil **tanker** used to collect drainings, tank washings and other oily mixtures.

Slow steaming – The operation of a ship at a lower speed than normal one in order to save fuel on ballast voyage or when fuel is expensive. Wärtsilä has introduced a new Upgrade Kit for Slow Steaming for RTA and RT-flex low-speed engines to improve the engine's efficiency when running off its design point. The Upgrade Kit allows Wärtsilä low-speed marine engines to be operated continuously at any power in the range of 20% to 100%. This means that with the Upgrade Kit ships can sail continuously at sea speeds down to some 60% full speed.

Slop Water Cleaning – Drilling with both oil-based mud and synthetic based mud generates waste streams, often referred to as 'slop mud' or 'slop water', which are produced when an oil/synthetic/diesel-based drilling fluid becomes contaminated with water.

Hydrocarbons render these slops ineligible for overboard discharge.



Picture courtesy of Wärtsilä Corporation

Wärtsilä Slop Water Cleaning unit

Wärtsilä Slop Water Cleaning is designed to clean mud or water contaminated with slop or drilling mud from drilling rigs and drilling ships. The processing principles are based on a combination of chemical treatment and dissolved air flotation. The chemicals flocculate and bind together particles, making them easier to separate, which then allows flotation by dissolved air to separate both particles and oil from the water. The result is clear water free of particles and oil, acceptable to be discharged to the environment or reused.

Sludge – The residue from any oil separation process which is usually a mixture of water, solid material and high viscosity oil.

Sludge discharge – Ejection of sludge from the separator bowl.

Sludge oil – Sludge oil means sludge from the fuel or lubricating oil separators, waste lubricating oil from the main or auxiliary machinery, or waste oil from bilge water separators, oil filtering equipment or drip trays, (**MARPOL**).

Sludge tank – A tank provided to receive oily residues coming from the oily water filtering or separating equipment and from the purification of fuel and lubricating oils.

The sludge tank should be easy to empty and inspect. The tank height must not be less than 400mm. The tank floor should have a slope of minimum 15°.

Sluice valve – A large valve in which a rectangular or circular gate slides across the opening. It has been used in oil tankers to permit gravity flow from tank to tank, with the valve being operated from the weather deck.

Small waterplane area twin hull (SWATH) – A **catamaran** with unconventionally shaped hulls: two submarine-like floating bodies lie deep under the water surface and thus create the required **buoyancy**. On the **waterline** the vessel offers the least possible working surface (water plane area) so that the backward forces are low. In this way, the movement of the ship caused by external forces is only slight. As a result, the vessel lies exceptionally stable and quiet on the water, even in case of heavy sea. The US Navy commissioned the

Small waterplane area twin hull (SWATH)



Photo: J. Babicz



Photo courtesy of Abeking & Rasmussen

SWATH type ship KAIMALINO that has been operating successfully in the rough seas off the Hawaiian islands since 1975.

In 1999, the German pilots started to work with two 25m SWATH pilot tenders, followed by a 50m SWATH pilot station ship ELBE built in 2000 by the German shipyard Abeking & Rasmussen. Both the station ship and the pilot tenders have excellent seakeeping performance and manoeuvring capabilities. During adverse weather conditions, the pilot



SWATH Pilot Tender

transfer service can continue even at a waveheight of 3.5m (wind force 10-11). See also **SWATH research vessel PLANET**. *Useful website: www.abeking.com*

Smit bracket – A fitting for securing the end link of a chafing chain, consisting of two parallel vertical plates mounted on a base with a sliding bolt passing through them.

Smoke – Smoke can be black, blue, white, yellow or brown in colour. Black smoke is mainly comprised of carbon particulates (soot). Blue smoke indicates the presence of the products of the incomplete combustion of the fuel or lubricating oil. White smoke is usually condensed water vapour. Yellow smoke is caused by **NO_x emissions**. When the exhaust gas is cooled significantly prior to discharge to the atmosphere, the condensed NO₂ component can take brown colour.

Smog – A mixture of pollutants, principally ground-level ozone, produced by chemical reactions in the air involving smog-forming chemicals. A major portion of smog-formers comes from burning petroleum-based fuels such as gasoline. Other smog-formers, volatile organic compounds, are found in products such as paints and solvents. Smog can harm health, damage the environment and cause poor visibility. Major smog occurrences are often to heavy motor vehicle traffic, sunshine, high temperatures and calm winds or temperature inversion (weather condition in which warm air is trapped close to the ground instead of rising). Smog is often worse away from the source of the smog-forming chemicals, since the chemical reactions that result in smog occur in the sky, while the reacting chemicals are being blown away from their sources by winds, (EPA).

SMPEP – see **Shipboard Marine Pollution Emergency Plan**.

Society of Naval Architects and Marine Engineers (SNAME) – An US based non-profit, technical organisation founded in 1893. SNAME is dedicated to promoting the art, science and practice of naval architecture, shipbuilding and marine engineering. The Society scope includes all aspects of research, production, maintenance and operation

of ships, submersibles, yachts, boats, offshore and ocean bottom structures, **hydrofoils** and **surface effect ships**. Address: 601 Pavonia Avenue, Jersey City, N.J. 07306, www.sname.org

Society of International Gas Tanker and Terminal Operators (SIGTTO) – An organisation dedicated to the promotion of safe and reliable operation of gas tankers and terminals. Based in London, SIGTTO represents around 90 per cent of world's **LNG** terminals and ship operators, and 50 per cent of **LPG**. SIGTTO London Liaison Office 17 St. Helen's Place, London EC3A 6DG, England www.sigtto.org, secretariat@sigtto.org

Soft coating – Coating which does not dry or which partially dries. It remains soft during its life time.

SOLAS – International Convention on Safety of Life at Sea adopted in 1974 by **IMO**. The 1974 Convention has been modified on a number of occasions: changes were introduced, amendments were adopted and new chapters were added. The Convention applies only to ships engaged on international voyages, it does not apply to ships of war and troopships, cargo ships of less than 500 gross tonnage, ships not propelled by mechanical means, wooden ships of primitive build, pleasure yachts not engaged in trade and fishing vessels.

Further reading: SOLAS Consolidated Edition 2004.

SOLAS 90 – The amendments concerning the way in which the subdivision and damage stability of dry cargo ships was to be calculated.

SOLAS 90 + 50 – see **Stockholm Agreement**.

Solids – The non-volatile matter in a paint composition, i.e. the ingredients. After drying they create the paint film.

Solvents – Liquids, usually volatile, used in the manufacture of paint to dissolve or disperse the binder-forming constituents, and which evaporate during drying and therefore, do not become a part of the dried film.

Solvent-free coating – It is a 100% solid coating. For practical purposes this may be extended to cover materials containing a small amount of volatile constituent of the binder (solventless).

Sonar – Sound Navigation Ranging. Electronic equipment which provides the means to search and detect submerged obstructions such as reefs or sunken ships that endanger sea routes. The basic sonar system consists of a display console, a transmitting/receiving unit, transducer unit, control unit, and power supply. A sonar transducer emits ultrasonic pulses horizontally around the ship. Echoes of targets are received and the picture is displayed on the screen.

Soot blowers – Equipment used to remove the products of combustion from boiler tubes. Rotating nozzles may be used in low temperature region whilst retractable lances with holes along their length are used in high temperature regions. In most cases steam is blown into them, however, compressed air may be also used.

Sophisticated paints – Paints based on unconventional binders, such as epoxies, chlorinated rubbers, vinyls etc.

Sounding pipe – A pipe which leads down to almost the bottom of a tank to enable the depth of liquid to be measured by a sounding tape. A striking pad must be located on the tank bottom beneath the pipe.

Sounding pipes are to end above freeboard deck in easily accessible places and are to be fitted with efficient, permanently attached, metallic closing appliances.

Source of electrical power:

Emergency source of electrical power – A source of electrical power intended to supply the emergency switchboard in the event of failure of the supply from the main source of electrical power, (acc. to SOLAS Chapter II-1, Part A).

Main source of electrical power – A source intended to supply electrical power to the main **switchboard** for distribution to all services necessary for maintaining the ship in normal operational and habitable condition, (acc. to SOLAS Chapter II-1, Part A).

SO_x SCRUBBER SYSTEMS

If the vessel operates in areas where SO_x emissions are controlled, compliance can be achieved using low sulphur fuel, or by cleaning exhaust gases using SO_x scrubbers. Wärtsilä has developed an open loop, a closed loop and hybrid scrubber systems. The basic technology in all these systems is the same. When exhaust gas enters system, it is sprayed with water. The SO_x reacts with water to form sulphuric acid. In an open loop system, the natural alkalinity of the seawater neutralizes the acid. In closed loop system, caustic soda helps to do this. The hybrid approach enables operation in closed loop mode when required, for instance whilst in port and during maneuvering using caustic soda. When at sea the switch can be made to open loop using only seawater.

Wärtsilä Open Loop Scrubber System

Wärtsilä Open Loop Scrubber system benefits from Hamworthy's 50-year know-how. The system operates in an open loop, utilising seawater to remove SO_x from the exhaust. Exhaust gas enters the scrubber and is sprayed with water in three different stages. The sulphur oxide in the exhaust reacts with water and forms sulphuric acid. There is no need for chemicals



Photo courtesy of Wärtsilä Corporation

*Test installation mounted in 2007 onboard a tanker MT SUULA
SO_x reduction > 99%, NO_x reduction 5 – 11%, PM reduction 30 – 60%*

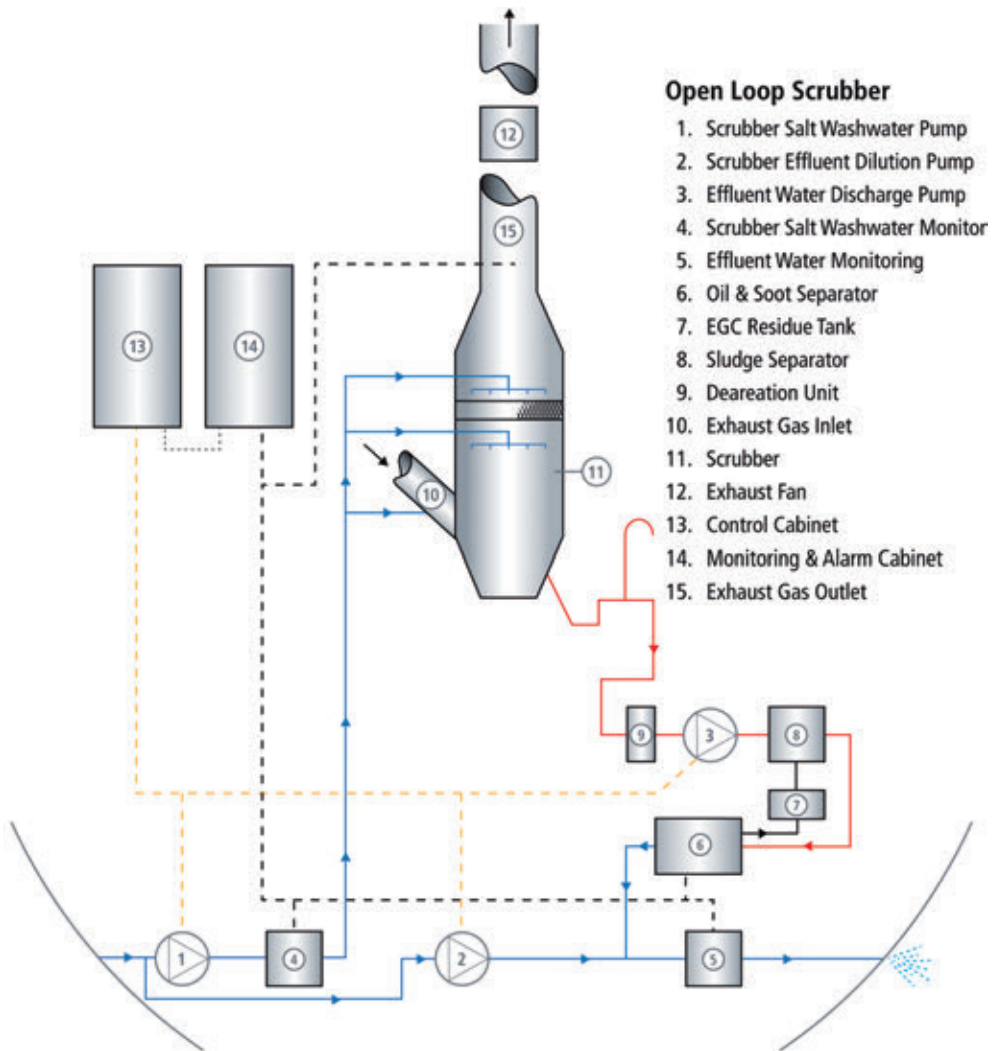

Open Loop Scrubber

1. Scrubber Salt Washwater Pump
2. Scrubber Effluent Dilution Pump
3. Effluent Water Discharge Pump
4. Scrubber Salt Washwater Monitor
5. Effluent Water Monitoring
6. Oil & Soot Separator
7. EGC Residue Tank
8. Sludge Separator
9. Deaeration Unit
10. Exhaust Gas Inlet
11. Scrubber
12. Exhaust Fan
13. Control Cabinet
14. Monitoring & Alarm Cabinet
15. Exhaust Gas Outlet

OPEN LOOP SCRUBBER SYSTEM

According to ABS Exhaust Gas Scrubber Systems Advisory

since the natural alkalinity of seawater neutralizes the acid. Wash water from the scrubber is treated and monitored at the inlet and outlet, to make sure it is in line with the discharge criteria of MEPC 184(59), before it is discharged to sea with no harm to the environment. LINEA MESSINA has an open loop scrubber system installed, and was the first vessel ever to operate commercially with a scrubber system, enabling it to meet 0.1% sulphur emissions regulations in EU ports, as well as “future proofing” the vessel for the impending 0.1% Emission Control Area limit in 2015.

Wärtsilä Closed Loop Scrubber System

Wärtsilä Closed Loop Scrubber operates in a closed loop, i.e. the wash water is being circulated within the scrubber. Only a small bleed-off is extracted from the loop and fresh water and alkali is added. The SO_x reduction efficiency is 97,15%, corresponding to a reduction of fuel sulphur content from 3.5% to 0.1%.

Scrubbing water is pumped from the wet sump through the cooler to the top part of the scrubber. Scrubbing water is sprayed into the exhaust gas flow from the spray nozzles in the scrubber. Water is also supplied to the mid part of the scrubber to further improve the SO_x removal efficiency.

Scrubbing water passes through the packing bed and is collected and removed through the bottom. The water absorbs SO_x emissions, heat and other components from the exhaust gas stream. The pH of the scrubbing water and thus the cleaning efficiency, is automatically monitored and controlled by alkali dosing.

The fresh water consumption is case dependent, but as estimation, 0.2 m³/MWh can be used. Fresh water topping-up is needed to compensate scrubbing water evaporation losses and extracted bleed-off. The topping-up water supply is connected to the scrubbing water wet sump or pump module. Fresh water is also supplied to the droplet separator on top of the scrubber for periodical rinsing.

The caustic soda is automatically added to the scrubbing water circulation to maintain the process pH and consequently the SO_x removal efficiency. The main components of the alkali feed system are the alkali pump, alkali feed control and alkali storage tank. The caustic soda consumption in weight is roughly 6 -15% of the diesel engine fuel oil consumption depending on the sulphur content and cleaning efficiency.

To remove the accumulated impurities from the scrubbing water a small flow of bleed-off is extracted and led to the emulsion breaking water treatment unit. The bleed-off contains traces of oil and combustion products, and its pH is typically close to neutral. Clean effluent from the treatment unit is discharged overboard, or led to the effluent holding tank when overboard discharges are to be avoided. Effluent quality monitoring is arranged before the discharge.

The extracted bleed-off from the scrubbing water circulation can be led to a bleed-off buffer tank prior to the treatment unit. A bleed-off buffer tank can be arranged to offer operational flexibility, permitting operation of the scrubber with the treatment unit out of operation.

Further reading: Wärtsilä Environmental Product Guide

Spaces – Separate compartments including holds and tanks.

Spar platform, also deep draft caisson vessel – see **OFFSHORE PRODUCTION AND STORAGE INSTALLATIONS**.

Spark arrester – A device which prevents spark from the combustion in prime movers, boilers, etc. from reaching the open air.

Spatters – Metal particles expelled during fusion welding that do not form a part of the weld.

Special category spaces – Enclosed spaces above or below the **bulkhead deck** intended for the carriage of motor vehicles with fuel in their tanks for their own propulsion, into and from which such vehicles can be driven and to which passengers have access, (SOLAS).

Special hull penetrations – Hull penetrations for installations such as echo sounder, speed log, and impressed current **cathodic protection system**.

Special purpose ship – A mechanically self-propelled ship which, by its function, carries on board more than 12 special personnel, including passengers (ships engaged in research, expeditions and survey; ships for training the marine personnel; whale and fish factory ships not engaged in catching; ships processing other living resources of the sea, not engaged in catching).

Specifications, Contract Specifications, Newbuilding Specifications, Technical Specification – Technical Specification is, beside the Contract, the most important contractual document that shall describe exactly characteristics of the new vessel, define Rules to be complied with and procedures to be followed during all stages of designing and construction.

As any important document, the Specification shall be easy to understand and is to have logical construction. It is not easy to build new vessels smoothly, without mistakes, misunderstandings and costly delays. With good Specification it is possible. The Specification in wrong English, with lack of order, mistakes and false statements, frequent repetitions or general statements without practical value will be the nightmare for all involved in design, building and surveying subject vessels.

Note:

1. *Specification shall be one document with one common and active Index and continuous page numbering.*
2. *Specification shall describe the subject of the contract as exactly as possible.*
3. *As far as reasonable, the equipment, machinery or system shall be described in one place only.*
4. *Specification shall define all the procedures such as the approval of drawings by Owners, testing of the vessel, etc.*
5. *To avoid misunderstandings, simple English shall be used. As far as possible terms from International Conventions shall be used.*
6. *For easy reference separate statements, remarks or requirements shall be properly numbered.*
7. *Specification shall be corrected in order to insert all modifications agreed during the approval of technical documentation. For this purpose, any agreement on changes related to the Specification should end with an agreement on a new wording. This altered document should be prepared after approval of the technical documentation. Signed by both Parties, it will be the base for the acceptance of the ship.*

Specified maximum environmental conditions – The wind speed, ambient temperature, seawater temperatures, current and wave height under which the vessel is designed to carry out intended operations.

Speed – The speed of a cargo ship influences significantly the ship's earning potential, hence there is a tendency to increase it. While defining the speed requirements of a new vessel, one need to bear in mind that shaft power is proportional to the cube of speed and that the higher speed equals higher costs.

In the past, container ships were constructed to reach the speed of 30 knots but fuel crisis put this practice to an end. Nowadays, giant container ships sail with the speed of 25 knots, but the increasing fuel costs impose further reductions. It happens that a ship designed to move with the speed of 25 knots in practice does not move faster than 18 knots.

The true speed of a vessel is changeable. It depends on the state of sea, draft, trim, the condition of the hull surface and the propeller. Rough sea equals bigger resistance. Bigger draft means bigger wetted surface, which in turn increases friction resistance. Hull or propeller overgrown with sea plants may reduce the speed dramatically. Due to those factors, the speed of a vessel decreases along with the vessel's age.

In practice, the notion of service speed is used, this understood as vessel's average speed in a longer period of time. For a vessel to move with the expected service speed, it needs

to have surplus of power, so-called sea margin. The value of sea margin depends on the region where the ship operates.

On the basis of the required service speed and the region where the ship operates, a designing bureau should define a sea margin required and the design speed for the design draft in the sea trial conditions. This parameter is guaranteed by the shipyard.

It is very important that the Technical Specification contain the correct information on the guaranteed speed and service speed. Unfortunately, such records are often incorrect, presenting no practical value in questionable situations.

Speed logs – Ship speed measuring devices.

Doppler log – An acoustic speed log based on the Doppler effect in which the wave lengths of moving objects appear to shift in relation to the observer. This shift can be converted to speed, thereby giving a very accurate result.

The Dual Axis Doppler Speed Log utilizes the Doppler shifted returns from high frequency acoustic energy transmitted into water to provide precise speed data, distance travelled, and water depth below the transducer. The transmitted signal is scattered back from the sea bottom and/or scatters in the water mass. The system amplifies the received signals and processes them to determine the Doppler shift. The time required for the signal to bounce back from the sea bottom is measured to calculate depth. The standard system consists of a Master Display Unit, an Electronics Unit, a Transducer Assembly, a Sea Chest or Tank, and interconnecting cabling.

Electromagnetic log – The electromagnetic log works by generating a small alternating current in a transducer producing an electromagnetic field in the adjacent water. As the vessel moves through the water, the voltage proportional to the speed is generated at 90 deg to the direction of travel. This signal voltage is detected by the probes and transmitted to the master electronic unit where it is amplified and processed digitally before being passed to the speed and distance displays.

Speed trials – Test runs which are carried out by a newly completed ship to determine its speed, the engine revolutions per minute and the power developed.

See also **HSVA Speed Trial Analysis**.

Spill control gear – Special equipment for fighting accidental oil spills at early stages.

Spindle – A part of a machine which rotates, e.g. lathe spindle, or a pin upon which another part turns.

Splash proof – An enclosure which protects electrical equipment from drops of liquid or solid particles which fall onto it or travel along a straight line at any angle not greater than 100 degrees from the vertical.

Splashproof chemical overall – The chemical overall used as a protection suit when a gastight clothing is unnecessary. It provides effective protection against chemicals, oils, etc.

Split-joint – The term for a cross-joint at which the panels separate, i.e. they are not hinged together.

Splinker – An apparatus used for fire-fighting purposes.

Sponsons – Projections (buoyancy casings) from each side of the hull used sometimes on **ro-ro** ferries to enhance their stability.

Spread Mooring – A type of **Position Mooring System**. It is a system with multiple catenary mooring lines anchored to piles or drag anchors at the seabed. The other end of each line is individually attached to winches or stoppers on the **Floating Installation Vessel** through **fairleads** as necessary. A catenary mooring line may have one or more line segments, in-line buoys, or sinkers along the line.

Spreader – A frame containing four **twistlocks** on its bottom corners which fit into the top container castings.

Spreading rate – The area which is covered by one litre of paint.

Spring lines – see **Mooring lines**.

SPS deck overlay – see **Sandwich Plate System**.

Squat – Ship squat is the overall decrease in the static underkeel clearance, forward or aft, created by dynamical sinking of a ship when moving ahead. When a ship proceeds through water, she pushes water ahead her. In order not to have a “hole” in the water, this volume of water must return down the sides and under the bottom of the ship. The streamlines of return flow are speeded up under the ship. This causes a drop in the pressure, resulting in the ship dropping vertically in the water.

Stability – Ship stability is the ability of a ship to float in an upright position and, if inclined under action of an external force, to return to this position after the external force has ceased acting.

Stability is not connected with a defined direction. However, ship inclination in transverse direction is most common and easiest to achieve and in practice transverse stability is the most critical to ship safety.

Stability of a loaded ship depends on her shape and dimensions and on the actual location of her centre of gravity. Small ships with low freeboard are more prone to stability accidents than other seagoing vessels.

After a ship is constructed, an operator has no influence on shape, dimensions, as well as mass and location of the centre of gravity of an empty vessel. Still, he has an influence on the final mass of the loaded vessel and the location of the centre of gravity defining amount of cargo, stores and ballast water as well as their locations.

A number of ship operations can adversely affect stability. Such effects must be understood and, where possible, mitigated. When liquid is consumed or removed from tanks than a free surface is created which decreases stability. When a weight is lifted and suspended, its centre of gravity rises to the point of suspension. When a quantity of loose dry bulk cargo moves transversely across the ship, it will list to one side with some loss of stability. Phenomena such as absorption of moisture by timber or similar deck cargoes, ice accretion on decks and accumulation of shipped water will rise the vertical centre of gravity VCG reducing the righting arm GZ.

Damage stability – Stability of the ship in flooded condition. This stability is attained by installing a number of watertight compartments. If one of these compartments is breached, then the watertight **bulkheads** surrounding it will prevent the inflow of seawater from spreading to the rest of the ship. See also **Damage stability calculations**.

Further reading: “Ship Stability in Practice”

Stability Booklet, Stability Information – see **Loading and Stability Manual**.

Stability data – Stability data are a set of data resulting from ship design process. It covers stability characteristics pertaining to a specific ship. Stability data constitute the base for

ship stability calculation in operation, especially stability assessment, by means of hand made calculations or by **stability instrument**.

Stability documentation – Onboard Stability Documentation is the part of As Build Drawings. In order to operate the ship in a safe way, the documentation must be legible, clear and easy to use. Scope of this documentation depends on ship type.

For multi-purpose vessel equipped for carriage of containers the following documents must be prepared:

No.	Document	Name of file
	Main documents	
1	Loading and Stability Manual (LSM)	Ship_ABD_LSM_Number
2	Subdivision and Damage Stability Calculations	Ship_ABD_Damage Stability_Number
3	Damage Control Manual (booklet)	Ship_ABD_Damage Manual_Number
4	Damage Control Plan (drawing for wheelhouse)	Ship_ABD_Damage Plan_Number
5	Watertight Integrity Plan	Ship_ABD_Watertight Integrity_Number
6	Stability Information for Carriage of Grain in Bulk	Ship_ABD_Grain Stab_Number
	TECHNICAL INFORMATION	
	Capacity Plan:	
7	General Arrangement Plan	Ship_ABD_GAP_Number
8	Load Line Mark	Ship_ABD_Load Line Mark_Number
9	Draught Marks	Ship_ABD_Draught Marks_Number
10	Deadweight Scale	Ship_ABD_Deadweight Scale_Number
	Tank Space Information	
11	Tank Arrangement Plan	Ship_ABD_TAP_Number
12	Tanks (booklet)	Ship_ABD_Tanks_Number
13	Tank Scaling Tables for Manual Sounding	Ship_ABD_Scaling Manual_Number
14	Tank Scaling Tables for Remote Level Control Sensors	Ship_ABD_Scaling Remote_Number
	Cargo Hold Information:	
15	Container Stowage Plan	Ship_ABD_Container Stowage_Number
16	Cargo Hold Scaling for Bale	Ship_ABD_Hold Scaling Bale_Number
17	Cargo Hold Scaling for Grain	Ship_ABD_Hold Scaling Grain_Number
	Various:	
18	Hydrostatic Data Tables	Ship_ABD_Hydro_Number
19	Cross Curves Tables	Ship_ABD_Cross Curves_Number
20	Visibility Tables	Ship_ABD_Visibility_Number
	Reports:	
21	Inclining Experiment Report	Ship_ABD_Inclining Rep_Number
22	Light Mass Measurement Report	Ship_ABD_Lightmass Rep_Number

Stability instrument

All files should have basic information included in their name:

- Name of a vessel or vessel type: ARIADNA, VENUS, etc,
- ABD (As Built Drawing)
- Short name of document
- Number according to system used by a design office

Example: ARIADNA_ABD_Grain Stab_0421-006

Further reading: “*Ship Stability in Practice*”

Stability instrument – A stability instrument is an onboard instrument comprising hardware and software, by means of which all relevant stability information is provided and all calculations or checks can be performed as necessary to ensure compliance with the applicable stability requirements.

Stacking cover – A type of a hatch cover in which the individual panels may be stacked to provide various opening arrangements.

Stairways – Interior stairways, lifts and escalators (other than those entirely contained within the machinery spaces) and enclosures thereto. In this context, a stairway which is enclosed only at one level is to be regarded as a part of the space from which is not separated by a fire door. Stairways penetrating only one level are required to be enclosed in “A” class bulkheads at one level. If penetrating more than one level, the requirement is for complete enclosure at all levels.

Stanchion – A vertical column supporting decks, flats, girders, etc; also called a pillar. Rail stanchions are vertical metal columns with fence-like rails mounted on them.

Standard fire test – A test in which specimens of the relevant **bulkheads** or **decks** are exposed in a test furnace to temperatures corresponding to the standard time-temperature curve as defined by Annex 1 of Part 3 of **IMO** Fire Tests Procedures Code.

Standard loading conditions – Loading conditions to be examined for the purpose of assessing whether the stability criteria are met. For a cargo ship the standard loading conditions are as follows:

1. Ship in the fully loaded departure condition with cargo homogeneously distributed throughout all the cargo spaces and with full stores and fuel.
2. Ship in the fully loaded arrival condition with cargo homogeneously distributed throughout all the cargo spaces and with 10% stores and fuel.
3. Ship in ballast in the departure condition without cargo but with full stores and fuel.
4. Ship in ballast in the arrival condition without cargo and with 10% stores and fuel remaining.

Standby rescue vessel STRIL POSEIDON

The rapid response rescue vessel STRIL POSEIDON was built by Aker Langsten for Simon Møkster Shipping in Stavanger. It is designed to remain on-station the year-round except for annual drydocking for maintenance. The cargo of food and water is loaded when the vessel reaches the offshore platforms. It can be refuelled at sea. The vessel can store up to 1000m³ of marine diesel oil as well as 250m³ of fresh water and 1100m³ of ballast water.

The vessel has **accommodation** for 25 persons as well as a sick bay and a helideck rated for a Super Puma (S92 optional) which makes it possible to ensure rapid medical assistance as well as to evacuate people from the vessel if necessary.

A key feature of the STRIL POSEIDON is an internal slipway built into the stern of the vessel, designed for the deployment of a Fast Rescue Daughter Craft. This is the first time such a system has been used on a field support/standby vessel.

The vessel has three main rescue boats: an NP-741 Springer, an MP-1111 FRDCWJ and an MP-710 TUG for oilboom towing. The man overboard boat is located in its own hangar located portside, midships.

The vessel is equipped with a Transres 150 system, oilbooms and skimmers for instant action on an oil spill. It also carries 50m³ of dispersant. The availability of such equipment offshore rapidly decreases the time necessary to respond to an oil spill incident.

The vessel can carry out emergency towing. The deck machinery includes a 120/250t towing winch, an 8.5m drum, a 22t tugger winch and a 10t capstan as well as a boat recovery winch, There is a 300t shark jaw and a 300t towing pin. The deck crane is rated for 5t at 10m.

The STRIL POSEIDON has an overall length of 91.4m, a length of 78.25m between perpendiculars and a draft of 6.5m. Its beam is 18.2m. The depth to the first deck is 7.5m and 4.5m to the second deck. It registers a deadweight of 2500t.

Standby rescue vessels – It is a requirement on most offshore fields to have emergency response and rescue vessels (ERRV) constantly on standby to evacuate personnel from rigs and platforms in the event of an emergency. The main requirements for ERRV to satisfy are that it should be capable of:

- rescuing from water or recovering persons and providing them with medical aid,
- acting as “place of safety”,
- providing on-scene coordination,
- monitoring the safety zone, warning approaching vessels and the offshore installation of the risk of collision and preventing same where possible,
- acting as a reserve radio station.

An ERRV should combine good manoeuvrability, enhanced survivor reception and medical after-care facilities, state of art navigational/communications equipment and rescue craft capable of operating in severe weather.

Many ERRVs are fitted with both daughter craft (DC) and fast rescue craft (FRC). In many respects the launch/recovery phases of both FRC and DC are limiting factors to their use and especially the recovery operation requires a high degree of professionalism and teamwork between the craft’s crew and those operating the davit on board the ERRV.

In some cases the weather conditions are too severe to launch rescue craft and in these circumstances ERRVs are provided with a mechanical recovery device to recover survivors directly from the sea. The most common equipment is Dacon Scoop: a crane operated rescue net for recovery of casualties from the water directly on board rescue vessel.

BP’s Project Jigsaw – A totally new concept for offshore rescue and recovery operations in the North Sea. Cover for each Jigsaw region includes a 93m multi-role regional support vessel (RSV), which will accommodate modules for two autonomous rescue and recovery crafts (ARRC) and two fast rescue craft (FRC), a recovery area suitable for 300 survivors, and rescue craft accommodation.

Starboard side – The right-hand side of a ship when looking forward. Opposite to port.

Static load – A load that results in the development of a stress field within a body without any acceleration of any part of it.

Statutory certificates – International Load Line certificate, Cargo Ship Safety Construction certificate, Cargo Ship Safety Equipment certificate, Cargo Ship Safety Radio certificate, International Oil Prevention certificate. Governments have a duty under different conventions to issue the relevant certificates for their own flag vessels, although they may delegate their authority, and often do so, to the classification societies. When authorised by the government concerned, the classification society surveys the ships, as regards to the enforcement of the provisions of international regulations, report and issue or cause the issue of the corresponding certificates.

Statutory surveys – Statutory surveys are required to satisfy International Convention requirements such as **Load Line**, **SOLAS**, and **MARPOL** and are supplementary to Class requirements. Statutory surveys may be carried out by the **Classification Society** on behalf of the particular government when they are authorised to do so by the government concerned.

Stays -

1. A term for bulwarks and hatch coaming brackets.
2. Wires or ropes from the deck to the head of a mast, samson post or boom to provide support or prevent movement.

Steam – It is water vapour at a temperature of 100°C or more. It is a colourless, invisible gas. The white clouds which are frequently called “steam” consist of droplets of liquid water formed by the condensation of steam. Steam is used as a source of power, as a means of conveying heat from one place to another and as a raw material in many chemical operations as, for example, in the manufacture of hydrogen.

Superheated steam is the steam of temperature raised to the required degree as, for instance, by passing it through red-hot tubes.

At normal pressure, steam condenses to water at 100°C. At increased pressure, however, it may be condensed even at higher temperatures. Above 374°C steam cannot be condensed to liquid water by any applied pressure. Hence 374°C is described as the critical temperature of steam.

Steam trap – A special type of a valve which prevents the passage of steam but allows the condensate to pass. It works automatically and is put into drain lines so that they drain off the condensate automatically without passing any steam.

Steam turbine – A device for obtaining mechanical work from the energy stored in steam. Steam enters the turbine with a high energy content and leaves it after giving off the most of it. The high pressure steam from the boiler expands in nozzles to create a high velocity steam jet. This jet is directed into blades. The shaping of the blades causes a change in direction and hence the velocity of the steam jet. A change in the velocity for a given mass flow of steam produces a force which turns the turbine wheel.

Steel – Steel is an alloy of **iron** and carbon which is made of pig iron by removing the excess of carbon and the undesirable components by means of oxidation reactions. It is hard and strong.

Steel plates pre-treatment shop – Material delivered to the shipyard contains mill scale and rust. Before fabrication, plates and profiles are blasted and primed at the automatic blasting and paint priming facilities.

Steel products – Steel plates, coils, bars and other products. Stowage factors vary from 0.3 to 0.5 m³/t. Rust is a common form of damage and it is therefore essential that the hatches do not leak and that condensation is not allowed to form in the holds.

Steel-to-steel contact – The method of supporting the weight of a hatch panel whilst correctly maintaining the **design compression** of the seal.

Steering gear – The machinery, rudder actuators, steering gear power units and the means of applying torque to the **rudder stock** necessary for effecting movements of the **rudder**. Two types of electrohydraulically-powered steering gears are in common use: the ram and the rotary vane.

Auxiliary steering gear – The equipment other than any part of the main steering gear necessary to steer the ship in the event of failure of the main steering gear but not including the tiller, quadrant or components serving the same purpose, (acc. to **SOLAS**).

Main steering gear – The machinery, **rudder actuators**, steering gear power units, if any, and ancillary equipment and the means of applying torque to the **rudder stock** (e.g. tiller or quadrant) necessary for effecting movement of the **rudder** for the purpose of steering the ship under normal service conditions, (acc. to **SOLAS**).

Ram-type electrohydraulic steering gear – A ram-type electrohydraulic steering gear consists of two or four hydraulic rams, connected by a link mechanism or a Rapson slide mechanism to the tiller which turns the rudder. A link mechanism transfers the ram movement to the tiller and imparts maximum torque at 35° of rudder movement. The Rapson slide mechanism consists of a block or a sleeve, pivoted to the ram and guided by a crosshead, and arranged to slide on the tiller arm so that the moment arm increases as the rudder angle increases. The rams are moved by hydraulic fluid supplied under pressure by one or two pumps. Usually, two independent pumping units are provided. They are connected so that either may be used to operate the gear, thus eliminating the **classification society** rule requirement for auxiliary steering gear.

*Note: In a passenger ship, under normal service conditions, one unit works.
In a cargo ship both units work.*

Rotary vane steering gear – The rotary vane system works by introducing pressure into compartments formed between a stator fixed to the ship's structure and a rotor attached to the **rudder stock**. There are two or three vanes on the rotor and an equal number on the stator to form the compartments. When steering effort is required, the pressure is increased in the appropriate compartments. The pressure reacts against the fixed vanes and pushes the rotor (and the rudder stock) in the required direction.

To increase the available torque, the diameter of the unit is enlarged, although it is generally smaller than an equivalent ram type arrangement. Hydraulic pressures are also lower as the working area is larger than the total of the rams on the ram-type gear. Another advantage is the degree of rudder movement: that is up to 65° for Porsgrunn system, and up to 45° for Ulstein's Frydenbo. With ram operated gear the maximum degree of rudder movement is limited by the stroke of the cylinders and the scope of the slider mechanism. One potential disadvantage of the rotary vane system is that if there is a fault inside the unit, all steering can be lost and specialist repair is needed. With ram type gear for larger vessels there are four single-acting cylinders so if one ram fails then the steering is not totally disabled. The working parts are also accessible in the event of a necessary repair and the rams are relatively simple to replace if a spare is carried. According to the **Motor Ship** July 1996.

Steering gear compartment – According to **SOLAS** requirements, the steering gear compartment shall be readily accessible and, as far as practicable, separated from the

Steering gear compartment

machinery spaces. Handrails and gratings or other nonslip surfaces shall be arranged to ensure suitable working conditions in the event of hydraulic fluid leakage. Emergency escape shall be arranged.

Steering gear control system – The equipment through which orders are transmitted from the navigation bridge to the **steering gear power units**. Steering gear control systems comprise transmitters, receivers, hydraulic control pumps and their associated motors, motor controllers, piping and cables, (acc. to SOLAS).

Steering gear power unit – An electric motor and its associated electrical equipment in the case of electric steering gear, or an electric motor and its associated electrical equipment and connected pump in the case of electrohydraulic steering gear, or a driving engine and connected pump in the case of other hydraulic steering gear.

Steering nozzle – A nozzle pivoting on a vertical axis and fitted around a screw propeller. Steering nozzles create steering forces by means of a deflected jet. They are usually applied at highly-loaded propellers of tugs, inland watercrafts and research vessels.

Steering system – A system used for steering the ship. It is in constant use when the ship is underway, and any failure or malfunction may result in disaster. The steering system usually consists of: a **steering gear**, a control equipment, a **rudder carrier**, a **rudder** and a **rudder horn**. The steering gear provides a movement of the rudder in response to a signal from the bridge. The control equipment conveys a signal of ordered rudder angle from the bridge and activates the steering gear to move the rudder to the desired angle.

Stem – The bow frame forming the apex of the intersection of the forward sides of a ship. At its lower end it is rigidly connected to the **keel**. It may be a heavy flat bar or of rounded plate construction.

Stern – The after end of ship.

Pram type stern – Buttock flow stern.

Stern bearings, tailshaft bearings lub propeller shaft bearings – Bearings which support the **propeller shaft**.

Stern discharge system (SDS) – The system installed on FSOs and FPSOs for off-loading of crude oil to shuttle tankers.

Stern frame – A heavy strong member (large casting, forging or weldment) attached to after end of the keel.

Stern lines – Mooring lines leading ashore from the after end or poop of a ship, often at an angle of about 45 degrees to the fore and the aft line.

Stern ramp/door – Access equipment for **ro-ro** ships. The system consists of a watertight axial ramp/door with entering and bridging flaps. A separate top-hinged **watertight** door and a non-watertight ramp can be arranged. In cases where the ship ramp is replaced by a shore-installed link span, the stern door can be either a vertical sliding door (guillotine) or a top-hinged upward folding door.

Sterntube – The watertight tube enclosing and supporting the **propeller shaft**. It consists of a cast-iron or casted steel cylinder fitted with bearing surface within which the **propeller shaft**, enclosed in a sleeve, rotates. The sterntube is installed from aft and bolted to the stern frame boss. It can be press-fitted or installed with epoxy resin.

Sterntube after seal; spacer ring – A split ring mounted on the sterntube. Removal of this ring enables the housing to be moved with respect to the bush, with the result that the lip seals move to an unworn contact surface. This arrangement ensures the optimum use of the bush and significantly extends the life of the entire seal.

Sterntube bearings – Oil-lubricated white metal bearing usually consists of two bushes pressed into a stern-tube. Water lubricated bearings use only seawater for lubrication, thereby they eliminate any risk of oil pollution from the sterntube.

Sterntube lubricating oil systems – In principle, the sterntube aft seals can function without a lubrication system. However, the aft sealing functions better and has a longer life if it is fitted, like the forward sealing, with a lubrication system. Although dated, permanent oil lubrication without circulation is still used. Oil loss can occur if there is no counter pressure from the outboard water. The system with the circulation is safer. The aft sealing is connected by means of two oil lubrication lines to a settling tank. The oil is circulated by a small oil pump. Any seawater that has leaked through the damaged or worn water seals into oil system can be separated out in the settling tank. Similarly, any oil that has escaped from the oil seals can be drained to the waste oil tanks. Low and high level switches on the settling tank allow clear observation and monitoring of the functioning of the aft seals.

Sterntube seals, propeller shaft seals – A housing with series of seal rings clamped into position on the bush. Sterntube seals have to perform two separate functions, one is to ensure that water does not enter the engine room, the second one to allow the propeller shaft to rotate as smoothly and freely as possible. Oil lubricated sterntube requires two types of seals, one water/oil seal for the external arrangement (aft seal) and one oil seal for the inboard end (forward seal). Modern sterntube seals are highly-engineered units designed and manufactured to withstand a rigorous working environment for long periods.

Illustrations courtesy of Wärtsilä Corporation

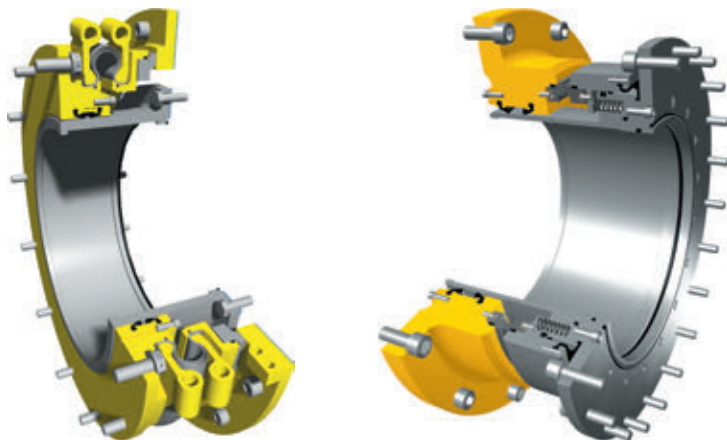

CoastGuard MC sterntube seal designed to ensure a long service life in cases with high axial shaft movement

Aft sterntube seal – The function of the aft seal is to prevent leakage of lubricating oil from the sterntube outboard, and to prevent seawater from entering the sterntube and contaminating the lubrication system.

The bush of the after seal is made from a high quality chrome steel resistant to corrosion and wear. In order to extend normal life, an optional ceramic coating can be applied. Viton seal rings are then mandatory. The housing is made from seawater resistant bronze. The lip seals are housed in accurately machined rings and are statically sealed by means of a clamping ring.

Illustrations courtesy of Wärtsilä Corporation



ManeGuard fully split stern tube seal for propulsion shafts of diameters ranging from 100mm to 320mm

Split stern tube seals – Split stern tube seals allow the renewal of both lip seal and bush in situ. Split after seals are mostly fitted in cases where the **classification society** has approved a long interval (10-15 years) between inspections. The split after seal permits inspection of the **propeller shaft**, particularly the area between the shaft and the flange in installations with CP propellers.

Stevodore – A person or firm employed to load and unload vessels.

Stiffener – A secondary supporting structural member: an angle, T-bar, channel, built-up section, etc. used to stiffen plating of a bulkhead, a deck, etc.

Stiffness – The resistance of the structure to deflect under load within elastic limit of the material.

Stirling engine – External combustion engine having an enclosed working fluid (as helium) that is alternately compressed and expanded to operate a piston.

Stockholm Agreement – The western European agreement for the **ro-ro** ferry safety reached in Stockholm in 1996 and is valid for **ro-ro passenger ferries**, irrespective of flag, trading regularly between two signatories' ports. According to Stockholm rules, a ferry must withstand 500 mm of water on its watertight vehicle deck when the residual freeboard in a damaged condition is below 0.3m. If the residual freeboard is above 2m, the 500 mm of water on deck is reduced to zero. The height of water is measured from the lowest point in the flooded compartment when trim and heel are taken into account. If that point is under the **waterline** in a damaged condition, the water height will be measured from the outside water level.

Stool –

1. A structure supporting cargo hold and tank bulkheads.
2. A support for a main bearing in the shaft alley, a foundation.

Stone damper – Stone-dumping vessels move large quantities of stone. A side stone-damper has a deck that is suitable for loading heavy consignments. Dozer blades are used to deposit the stone in the water at the destination. Fallpipe vessel is used to dump stones on the bottom in a precise location.

Stop valves – Valves to isolate machinery, equipment, and piping components for system operation, maintenance and overhaul, and damage control. There are four basic types of stop valves: gate, globe, ball, and butterfly.

Ball valve – Ball valves have a relatively short actuating mechanism and the body length, and provide a more compact installation than globe or gate valves.

Butterfly valve – Butterfly valves are the most compact of the stop valves; they have relatively low pressure loss.

Gate valve – The gate valve is closed by interposing a flat or tapered element (gate or wedge) transversally across the axis of the opening.

Globe valve – The globe valve is closed by pressing a disc axially against the opening. When the disc is not attached to the spindle, the globe valve is considered to be screw-down non-return valve (SDNR).

Stopper – A device for securing a mooring line temporarily at the ship whilst the free end is fastened to a ship bitt. A Carpenter stopper is a device with opening jaws to receive wire and shaped wedges to hold a line when tension is applied.

Storage and offloading buoy – A bottle-shaped tank with a buoyancy collar fitted around the neck. The lower part of the buoy provides a free-flooding space for the storage of oil to be discharged from a floating production unit.

“1 million barrel capacity (approximately 140,000tonnes) storage buoy has a diameter of 60m and a depth of 96m. The buoy is able to operate in water depths of up to 2000m and in wind speeds of 41 knots.”

Sto-Ro paper carrier BALTICBORG

The ice strengthened **Sto-Ro** vessel BALTICBORG was completed by Volharding Shipyards in 2004, using a hull from Daewoo Mangalia in Romania. The ship designed for transportation of **forest products** is arranged with three cargo decks, whereby sto-ro freight is accommodated on the main deck and in the lower hold, while the weatherdeck is used for containers, trailers, packed timber and other unitised goods.

Photo: P-H. Sjöström



A TTS-designed 16m long by 17.3m wide, single-section stern ramp/door gives access to the main deck. An internal fixed ramp on the port side leads to the upper deck, where another fixed ramp at starboards leads to the lower hold, closed at the main deck level by a side-hinged watertight cover. Paper reels and pulp-packages are loaded by means of forklift trucks of 15.8t axle loading, Mafi trailers of 32t, or road trailers of 20t load.

Stowage

The **propulsion system** of the BALTICBORG consists of a Wärtsilä main engine 9L46, featuring a maximum continuous rating of 9450kW at 500 rpm, a Flender Navilus marine reduction gearbox, and a 5000 mm diameter, high skew four-bladed Wärtsilä Lips CP propeller. The service speed of the vessel at a draught of 7.1m is 16.5 knots at 90%MCR and 20% sea margin

The main engine is fitted with a Wärtsilä Engine Control System (WECS): a computerized distributed real-time system for monitoring and control. The hardware consists of computers mounted on the main engine. The main functions are processed in the main control unit. A relay module contains back up and hardwired functions required by classification societies. The WECS communicates with external systems via a Modbus serial link. The CP propeller is controlled via a Lipstronic remote control system.

The BALTICBORG is one of the first cargo vessels with BV class notations "Clean Sea", "Clean Air". Low sulphur fuel (below 1%) is used, and the NO_x has been reduced to below 2g/kWh with **selective catalytic reduction**.

To comply with requirements of **ballast water management**, a new system "Optimar" was installed. This system uses hydrocyclones on the ballast system to remove particles from the water intake. After this pre-treatment, UV is used to kill micro-organisms and bacteria.

Length, oa: 153.05m, Length, bp: 144.20m, Breadth, mld: 21.60m, Depth, mld to the main deck: 8.40m, Deadweight: 10,254dwt, Draught design/scantling: 7.10m, Lightweight: 5826tonnes, Block coefficient: 0.719, Service speed: 16.5 knots. Main engine output 9450kW at 500rev/min.

Further reading: HSB International May 2004, Significant Ships of 2004

Stowage – The placing of goods in a ship to ensure the safety and stability of the ship.

Stowage factor – It is expression which indicates the cubic capacity that 1 ton of cargo will require. The stowage factor takes account of the design and shape of the cargo package and the need to employ dunnage or other special stowage provision. Stowage factor is expressed as a number of cubic metres per ton (m³/t) or cubic feet (cuft/t).

Iron ore	0.4-0.5 m ³ /tonne
Coal	1.2-1.4 m ³ /tonne
Grain	1.2-2.0 m ³ /tonne
Bauxite	0.7-1.1 m ³ /tonne
Steel products	0.3-0.6 m ³ /tonne

Stowage hooks – Hooks which hold a folded hatch cover.

Stowage rails – **Athwartships** rails upon which **side-rolling covers** run and are supported in the open position.

Stowaway – Someone who hides on a ship to avoid paying a ticket or to travel secretly.

Straddle carriers – Large vehicles that carry their load underneath the bridging between their wheels.

Strain – Any forced change in the dimensions of a structural member.

Strainer – A coarse filter to remove large contaminating particles. Sea inlets are to be fitted with strainers. Magnetic strainers are often used in lubricating oil systems, where a large permanent magnet collects any ferrous particles circulating in the system.

Strake – A strip of plating used in the outer hull structure, decks or bulkheads; for example bilge strake, keel strake, sheer strake, etc.

Stranding – The placing or landing of a vessel on a beach, a submerged object or reef, whereby vessel is no longer fully afloat and free. See also **Grounding**.



Photo courtesy of CARGOTEC

Shuttle carrier

Streamers – Measuring cables towed by the **seismic vessel**. Streamers typically comprise lengths of flexible plastic tubing joined end to end, filled with mineral oil to give neutral buoyancy and housing hydrophones and connecting and towing cables at intervals along their lengths. Large seismic vessels operate with up to twelve streamers at a time and some are capable of handling up to twenty. Vanes are used to spread the streamers so that they trail at a set separation, altogether covering an area of several square kilometres.

Strength deck – The deck that is designed as the uppermost part of the main hull longitudinal strength girder. The bottom shell plating sets up the lowermost part of this girder.

Strength of a structure – Ability of the structure to withstand the loads imposed on it.

Stress – The force per unit section area resulting in a deformation of a body.

Stress concentration, stress raiser – Any notch, crack, hole, corner, groove, attachment or other interruption to smooth flow of stress and strain in structure introduces a concentration of stress.

Stress monitoring system, hull stress surveillance system – Large tankers, bulk carriers or container vessels, where the hull girder stiffness is relatively low compared to their size, and which need hull monitoring systems to measure the forces, motions and resulting stresses caused by the sea state. The system includes various sensors, such as long-base strain gauges, rosette gauges and trio-axial accelerometers to monitor hull girder deck stresses and localised stresses on bulkheads, side shell, cross-deck strip and double

Stretcher

bottom structure. Real-time data from these sensors is provided for immediate use and for the evaluation of the course and/or speed changes.

Stretcher – A covered frame for carrying someone who is too injured or ill to walk.

Stringer –

1. A term applied to a fore-and-aft girder running along the side of a ship at the shell and also to the outboard strake of plating on any deck.
2. The side pieces of a ladder or staircase to which the treads and risers are fastened.

Stringer plate – The outside **strake** of deck plating.

Stripe coat (painting) – A coat used locally, before the first coat or between the first and the second coat, in locations where it is not easy to obtain the final thickness of paint by a simple application with gun (e.g. edges, welds, hard to reach areas, etc.).

Stroke – The travel of the piston between its extreme points: top dead center and bottom dead center.

Structural inspection – A close-up inspection of the hull structure and ultrasonic thickness measurements (**gauging**).

Structural test – A hydrostatic test carried out to demonstrate the tightness of the tanks and the structural adequacy of the design.

Strut – Outboard column-like support or V-arranged supports for the propeller shaft used on some ships with more than one propeller instead of bossings.

Stuffing Box Drain Oil Cleaning System – The oil drained from the **piston rod stuffing boxes** is mixed with sludge from the scavenge air space and has to be cleaned before it is led back into the lubricating system. The system is available as a module (Piston Rod Unit) and consists of a drain tank, a circulating tank with a heating coil, a pump with a fine filter, and also includes wiring, piping, valves and instruments.

Subdivision – The division of a hull into a series of watertight compartments by means of transverse and longitudinal watertight **bulkheads**.

Subdivision draughts – Initial draughts of the ship before damage which must be considered when calculating the attained subdivision index A.

Deepest subdivision draught (ds) is the waterline which corresponds to the summer load line draught of the ship.

Light service draught (dl) is the service draught corresponding to the ballast arrival condition with 10% consumables for cargo ships. For passenger ship it corresponds, in general, to the arrival condition with 10% consumables, a full complement of passengers and crew and their effects, and ballast necessary for stability and trim.

Partial subdivision draught (dp) is the light service draught plus 60% of the difference between the light service draught and the deepest subdivision draught.

See also **Damage stability calculations**.

Subdivision index – The measure of the ability of a ship to survive flooding accidents caused by collision or grounding.

Attained Subdivision Index "A" – The probability of survival of a vessel after collision or grounding. "A" is taken as the sum of the products of probability $p \times s \times v$ for each compartment or group of compartments where 'p' accounts for the damage position along the ship length, 's' the probability of not capsizing or sinking after such flooding, and 'v' the assumed vertical extent of damage.

Recognising that the actual loading condition at the time of any damage may vary, the calculations are to be carried out for the ship loaded to the deepest **subdivision load line**

and also at a partial loadline. The contribution to the total Attained Subdivision Index "A" for the calculations at each of these draughts is 0.5A at the deepest load line plus 0.5A at the partial load line.

Required Subdivision Index "R" – A required probability of survival in flooded condition. For general cargo ships and container ships the required subdivision index depends on the ship length, for passenger vessels it depends on the ship length and the number of persons onboard.

Subdivision length – The greatest projected moulded length of that part of the ship at or below deck or decks limiting the vertical extent of flooding with the ship at the deepest subdivision loadline.

Submerged arc welding (SAW) – An arc welding process that uses an arc or arcs between a bare metal electrode or electrodes and the weld pool. The arc and molten metal are shielded by a blanket of granular flux on the workpieces. The process is carried out without the application of pressure and with a filler metal from the electrode and sometimes from a supplement source (welding rod, flux, or metal granules).

Submerged turret loading (STL) system – The system of loading of a **shuttle tanker** directly from the production platform developed by Statoil and the Maritime Consulting Group. Crude is loaded through a **riser** extending from a subsea line from the platform. The riser is connected to a submerged buoy, moored to the seabed by eight anchor lines. This is lifted into a conical recess under the bow and hydraulically locked in place. The buoy is located by a hydroacoustic transponder and by TV cameras during the final approach.

Submersible – A self-propelled craft capable of carrying personnel and/or passengers while operating underwater, submerging, surfacing and remaining afloat. Internal pressure is normally maintained at or near one atmosphere.

Tethered submersible – A tethered self-propelled unit capable of carrying personnel and/or passengers underwater. Internal pressure is normally maintained at or near one atmosphere.

Wet submersible – A non-pressurised, open-hulled submersible at ambient pressure which is self-propelled and capable of ascent and descent, and which allows the divers access to the surrounding environment.

Subsea Construction Vessel BOA DEEP C

According to **Ship and Boat International** July/August 2004
and **Significant Ships** of 2004

Built in China at Jin Ling shipyard, and outfitted in Spain at Factorias Vulcano shipyard, BOA DEEP C is believed to be the world largest construction vessel. The vessel was designed by the well-known Norwegian consultancy Vik-Sandvik (now Wärtsilä Ship Design) for operations in the subsea market, tackling mooring systems, pipelines repairs, template and anchor installations. Particular benefit is derived from the vessel's ability to work at previously inaccessible sea depths of up to 2000m.

The deck area measures 1150m², and is reinforced for a specific load of 15t/m². It is served by two offshore heave-compensated cranes; 250t/13m and 30t/13m, and two cranes knuckle boom type with SWL of 15t/20m, 1 x 8.4t, and 1 x 6.3t marine cranes. A deepwater towing/anchor handling winch with a 500t line pull is provided, whilst the stern roller has a downward pull of 750t and a bollard-pull rating of 260t. The mooring and anchoring equipment includes two mooring winch/windlasses forward and two capstans aft, with various tugger winches,

Photo courtesy of Vik-Sandvik AS



guide winches and powered guide pins also installed. BOA DEEP C also boasts twin built-in deepwater ROVs of Oceaneering Millenium type and a 7.2m x 7.2m moonpool. The ROVs are located in hangars. Over the side a guided launching system for extreme condition operation is provided.

A very interesting feature of the vessel is the propulsion machinery designed to operate in three modes according to the operational requirements, these being diesel-mechanical for steaming; diesel-electric for use in DP mode; or diesel-mechanical with electric booster for maximum power in "bollard-pull mode". The machinery is based on six 3600 engines: a pair of V16-cylinder units on the main shafts, and two eight-cylinder and two six-cylinder models used as genset drives.

Each of the two engines is rated at 6000kW and drives a four-bladed 4.4m-diameter CP propeller in a nozzle via a ACG1080 gearbox, the direct-drive arrangement being used when steaming. For maximum bollard pull, the power on each shaft can be boosted by 3000kW from a Siemens combined PTI/PTO (electric motor/shaft alternator). A diesel-electric mode is used for DP operations, and positioning requirements are met by four 1425kW tunnel thrusters (two aft and two forward) and a 1200kW retractable azimuthing thruster located abaft the forward bow thruster.

Length, oa: 119.30m, Length, bp: 102.00m, Breadth, mld: 27.00m, Depth, mld: 11.60m, Draught design: 8.80m, Deadweight: 8492dwt, Lightship mass: 9493tonnes Service speed: 13.00 knots. Output 2x6000kW.

Suction anchor – A large hollow steel pipe forced into the seabed by means of a pump connected to the top of the pipe, creating a pressure difference. When pressure inside the pipe is lower than outside, the pipe is sucked into the seabed. After installation the pump is removed.

Suite – The most luxurious and spacious of all shipboard accommodation. A suite should be minimum of 37m², and should comprise a lounge or sitting room separated from a bedroom by a solid door; a bedroom with a large bed; one or more bathrooms, and an abundance of closets, drawers, and other storage space.

Sulphur tanker – A tanker designed to carry molten sulphur at high temperature, in independent, insulated tanks. The sulphur tanks are secured against rolling and pitching movement, but are allowed to expand or contract with different cargo temperatures.

Rockwool or equivalent insulation, covered with galvanised sheet, is fitted to the exterior of the tanks. The entire **cargo handling system** (pumps, valves, pipes and fittings) is fitted with heating jackets, and heating coils are arranged in the **cargo tanks**.

Sulphur tanker SULPHUR ENTERPRISE

According to **Significant Ships** of 1994

Built by McDermott's Shipyards, USA, the sulphur tanker has four holds fitted with self-supporting, insulated tanks, able to carry cargo at temperature between 127°C and 138°C and at specific gravity of 1.79. Each tank is 21.33m long, 20.72m wide and 9.14m deep and sits in its own hold on 14 pedestals. At the interface of each pedestal there is a special insulating pad supporting the tank, as well as insulating the hull from the heated cargo and allowing for expansion. Anti-roll and anti-pitch chocks prevent movement of the tanks in heavy seas or during a collision.

Each tank is fitted at its aft end with two deepwell pumps with a capacity of 500tons/h, although only one pump will be used at a time. The design allows the pumps to be removed and inserted while molten sulphur is in the tanks. All eight pumps lead to a common header on the main deck.

Heating of both cargo and engine room services is by thermal fluid equipment to avoid possible long-term heating coil failure inside the tanks if steam were to be used. To avoid contamination of engine room services with sulphur, two independent loops are used; The engine room primary one is heated by a waste heat economizer or auxiliary thermal fluid heater. This fluid is then passed through a heat exchanger to heat the secondary loop.

All cargo tanks are insulated by 100mm of glassfibre/expanded metal lath material, with 50mm on the thermal fluid lines. Each tank is additionally fitted with a de-humidified air bubbler and sweep air system to release any entrapped hydrogen sulphide in the cargo and to circulate the latter one.

Length, oa: 159.72m, Length, bp: 151.64m, Breadth, mld: 27.43m, Depth, mld to the main deck: 14.48m, Deadweight: 27,240dwt, Draught design/scantling: 10.06/11.28m, Service speed: 14 knots. Main engine Wärtsilä 8L46 output 9715bhp/500rev/min.

Summer waterline – The deepest waterline to which a merchant vessel is legally allowed to be loaded within certain specified geographical zones in the summer months, (ICLL).

Superstructure – A decked structure on the **freeboard deck** extending from side to side or with the side plating not inboard of the shell plating more than 4% of the breadth (B), (ICLL). A superstructure may be a **poop**, a **raised quarterdeck**, a bridge, a **forecastle** or a full superstructure.

Enclosed superstructure – The superstructure with bulkheads forward and/or aft fitted with weathertight doors and closing appliances.

Full superstructure – A superstructure which, as a minimum, extends from the forward to the after perpendicular.

Supertrawler HELEN MARY

According to **Significant Ships** of 1996

The large deep-sea freezer-factory trawler HELEN MARY has a flush upper deck with a three-tiered superstructure covering most of the aft two-thirds of the vessel. A two-man forward navigating console is matched by an operating desk aft with a full view over the working deck

Supply vessel

and offering remote control of the Brusselle trawl winch. Powered by two 350kW motors, it is fitted with two 51 tonne-pull wire drums, two 35tonne net drums, and four 25/33tonne pull auxiliary drums, all fitted with pneumatic couplings and brakes. There is also a Marelec auto-trawl system which automatically controls the winch motor to ensure the equal tension in both warps whilst fishing. A 4.4tonnes crane mounted on a gantry over the stern assists the handling of the various nets used for fishing at different depths.

Fish and water are removed from the nets by a Karmoy 1100m³/h fish pump into 12 refrigerated sea water tanks for pre-cooling. After passing through water separators, elevators take the fish to sorting machines, from there to the freezing room equipped with 40 freezers, each with 26 vertical plates. The blocks of frozen fish are then sealed into plastic wrappings and automatically placed in cartons, before being stored in the refrigerated and insulated cargo holds.

A Grenco refrigeration plant is capable of cooling down 660tonnes of fish from 20°C to -2°C in 4hours in the refrigerated seawater tanks, as well as supplying 20tonnes of slurry ice in 24hours, and cooling 30m³ process water from 30°C to -2°C in one hour. Two independent freon R22/brine systems make up the main plant which is driven by four compressors and allows the plate freezers to process 280tonnes of fish/day at -25°C by means of air coolers at the ship side.

Length, oa: 116.70m, Length, bp: 107.83m, Breadth, mld: 17.70m, Depth, mld to the upper deck: 13.05m, Volume of insulated hold: 6903m³, Deadweight: 6422dwt, Draught: 7.80m, Service speed: 17.65 knots. Main engine output 2x3960kW.

Supply vessel – A ship intended for carriage and/or storage of special material and equipment and/or which is used to provide facilities and assistance for performance of specified activities, such as offshore, research and underwater activities.

Surface Effect Ships (SES) – Vessels which benefit from an aerostatic force generated by a downward air current. See also **hovercraft**.

Surface finish of hot rolled steel plates – Steel plates must have a workmanlike finish and must be free from defects and imperfections which may impair their proper workability and use. This may, however, include some minor imperfections, e.g. pittings, rolled-scale, indentations, roll marks, scratches and grooves which cannot be avoided despite the proper manufacturing.

Further reading: IACS Publication No.12 **Guidelines for Surface Finish of Hot Rolled Steel Plates and Wide Flats.**

Surface preparation – A process of surface cleaning before paint application. The surface preparation is of great importance for the quality and the durability of the coating. The following substances are to be removed: metal oxides, scales, water soluble salts, old coatings, dust, grease and oil, foreign matters, humidity. The surface preparation can be achieved by one of the following methods: **blast-cleaning, mechanical cleaning, hydroblasting** and **electrolytic descaling**.

Surface preparation grades – The Swedish Standard Institution has published a very useful handbook entitled "Degrees of rust on steel surfaces and degrees for pretreatment of steel surfaces prior to application of rust preventing primers" (Swedish Standard 055900-1967). Standardized preparation grades in case of blast cleaning are Sa 0, Sa 1, Sa 2, Sa 2¹/₂ and Sa 3, for manual scraping and wirebrushing: St 2 and St 3.

Blast-cleaning

Sa 0: No preparation of surface.

- Sa 1:** Light blast cleaning. The jet passes rapidly over the surface so that loose millscale, rust and foreign matter are removed.
- Sa 2:** Thorough blast cleaning. The jet is passed over the surface long enough to remove all mill scale and rust and practically all foreign matter. Finally, the surface is cleaned with a vacuum cleaner, clean and dry compressed air or a clean brush. It should be grayish in colour.
- Sa 2,5:** Very thorough blast-cleaning. The mill scale, rust and foreign matter shall be removed to such an extent that only remnants appear as shades on the surface. Finally, the surface is cleaned with a vacuum cleaner, clean and dry compressed air or a clean brush.
- Sa 3:** Blast cleaning to white metal. The jet passes over the surface, long enough to remove all mill scale, rust and foreign matter. Finally, the surface is cleaned with a vacuum cleaner, clean and dry compressed air or a clean brush. It should then have a uniform metallic colour.

Manual scraping and wirebrushing

- St 2:** Thorough scraping (with hard-metal scraper) and wirebrushing – disc-sanding – etc. During the operation all the loose scale, rust and foreign matter should be removed. Finally, the surface is cleaned with a vacuum cleaner, clean and dry compressed air or a clean brush. It should then have a faint metallic sheen.
- St 3:** Extremely thorough scraping and wirebrushing, disc sanding, power brushing etc. Surface preparation as for St 2, but considerably more accurate. After removing the dust, the surface should have a pronounced metallic sheen.

Further reading: *ABS Guidance Notes on "The Application and Maintenance of Marine Coating Systems"*.

Surveillance boat – A fast boat used by coastguard service.

Survey – Examination, testing and evaluation of the results and decision making.

Damage survey – A ship survey conducted following the occurrence of damage, with particular attention to the damaged parts of the vessel.

In-water survey – A survey performed whilst a vessel is afloat.

Off-hire survey – A survey conducted following the completion of a charter.

Survey launches, tenders – Small motor boats carried on board the hydrographic vessel for use in surveying operations. These can work individually around sandbanks and in shallow waters or in conjunction with the survey vessel at sea.

Survey ship CAPELLA

The CAPELLA is the first larger survey ship built by Fassmer Shipyard for German Federal Marine and Hydrographic Authority (BSH) responsible for hydrographic survey activities and searching for shipwrecks, as well as for publishing of sea charts, nautical publications and the distribution of nautical warnings and announcements.

The main task of the CAPELLA is hydrographic surveying in shallow waters off the coast, and in particular the coastal bays in Mecklenburg-Vorpommern and the mud flats in Schleswig-Holstein and Niedersachsen. For the surveying tasks, apart from the mother ship with a draught of only 1.6 m, there are also two survey boats and a working rubber dinghy. All four units have similar surveying equipment, consisting primarily of top quality surveying depth sounders and surveying GPS receivers. Both convert the measurement of the water depth and that of the corresponding position into a depth profile registered with decimetre

accuracy continuously while the ship is moving. These profiles are extended to “profile mattresses”, a sequence of parallel tracks, and are thus used to portray the surface of the sea bed, primarily for making up sea charts.

The rubber dinghy with its jet drive can be used for surveying right up to the beach, i.e. up to water depths of approx. 50 cm. It is manned by a driver, a surveyor, a depth sounder and a DGPS system with a laptop and display for the driver.

The survey boats which work in the coastal areas at water depths from 1 m have more sophisticated equipment. The depth sounders work in two frequency ranges, the GPS position of the satellites is corrected using a differential procedure, and the boat 2 has a side scan sonar system. It is an acoustic ground measuring system taking pictures of the sea bed in near-photo quality. On the CAPELLA itself, surveying is carried out on a special panel on the bridge, using the same principle. The system also registers the ship movements and swell speed data, as well as the water levels at the water gauges around the German coast (this latter function by radio). Together with all these data, the sounding data from all four units undergo post-processing using complex software for filtering and error processing in the surveying office. The cleaned data are then processed into topographic charts of the sea bed, creating the basis for the actual sea charts later on.

Moving along the tracks and exact steering to the positions requires a navigation system which complies with the high surveying demands. A gyro-compass system, supplemented by a magnetic compass system which can feed the repeater compasses in an emergency, is responsible for the precise registration of the ship direction. The ship speed is registered with an electromagnetic log and a sat log. The rudder is controlled manually or by the autopilot. The radar system supplies images of the surroundings which are supplemented by an electronic sea chart. The gathered meteorological data are displayed on a PC monitor.

For internal communications (intercom, public address and paging system, telephone and signaling system running without batteries) and for external communications (GMDSS through to satellite communication systems, standard C), the ship is equipped with various systems going over and beyond the stipulated requirements. The survey boats and the rubber dinghy are included in the communications concept.

Source: www.fassmer.de

Survey systems of HMS ECHO and ENTERPRISE

According to **MER** March 2002

The multi-role hydrographic and oceanographic survey vessels ECHO and ENTERPRISE are designed for inshore and continental shelf operations. To serve their purpose properly the vessels require a range of instruments, some of them hull-mounted, others towed.

The hull-mounted multi-beam sonar is able to collect highly accurate seabed bathymetric and seabed imagery data at a daily rate.

Towed sensors gathering seabed backscatter data enable automatic classification of seabed type and identify small objects. Undulating through the water column from the surface to a depth of 500m, they are able to measure both biological and physical properties of the sea with high precision. The derived data is accurately positioned by remote sensing from the ship.

By the unique function developed between Kongsberg Simrad and Kelvin Hughes, data describing the planned survey lines are transferred to the **bridge** navigation system, enabling their display on the **ECDIS** consoles during survey.

Survey vessel – A vessel designed to carry out geophysical and geotechnical surveys.

The offshore survey tasks were augmented by nearshore and onshore studies for various landfalls in anticipation of the installation of offshore structures and pipelines and included seabed studies and tidal observations.

Surveyor – A person charged with inspecting and reporting on engineering equipment, structure, etc on behalf of private interests or an official body.

Survivability of the ship – A survival capability of a ship suffering some damage at site or bottom.

Survival craft – A craft capable of sustaining the lives of persons in distress from the time of abandoning the ship, (SOLAS, Chapter III).

Survival Crafts and Rescue Boat Arrangement – A classification drawing which shall contain sufficient information to check that proposed arrangement of **lifeboats**, **liferafts** and **rescue boat** meets all SOLAS requirements. It should be submitted to Shipowner and relevant Classification Society for approval at early stage of ship design.

Survival Systems International evacuation system – The evacuation system designed for use on offshore installations. A key element of the system is a self righting, oval dome-shaped capsule manufactured from fire-retardant fiberglass reinforced plastic. While launching, the craft should be battened down with all hatches and doors closed, the engine being started at the embarkation deck level before lowering is commenced. The capsule is equipped with a compressed air bottle system which enables the occupants to breathe normally when in the battened-down condition.

Suspect areas – Locations showing substantial corrosion and/or which are considered by the surveyor to be prone to rapid wastage.

Suspension – A mixture with solid particles dispersed in the continuous water phase.

SWATH research vessel PLANET

On February 1st, 2005 the maritime journal HANSA chose the research vessel PLANET as the “Ship of the Year 2004”. This twin-hull vessel was built by Nordseewerke in Emden. The vessel with a length of 72m and a width of 27.2m has a displacement of 3500 tons, which makes it the largest **SWATH** twin-hull vessel ever built by a German shipyard. But not only the size but also the technology is completely new. The PLANET is the first All Electric Ship (AES) built in Germany. The machines for propulsion and generators for energy supply are conceived in Permanent Magnet Excitation Technology. Her propulsion plant consists of two diesel gensets of 1275kW each, two diesel generators of 1700kW and four propulsion motors, all using PM technology. Even the ship mains and the ship propulsion network are used for the first time in this configuration on a sea-going ship. A special challenge for the shipyard were the high acoustic requirements for the vessel. For this purpose, the know-how from submarine technology was very helpful.

The service speed is 15 knots giving the ship an operational range of 5000 miles and an endurance of about 30 days. She carries a crew of 25 and also accommodates 20 scientific personnel. The main tasks of the PLANET are surface and underwater naval research as well as testing of navy-specific components, in particular torpedoes, and sonar equipment.

Switchboards:

Main switchboard – A switchboard which is directly supplied by the **main source of electrical power** and is intended to distribute electrical energy to the ship service, (SOLAS).

Photo courtesy of Nordseewerke



SWATH research vessel PLANET



Photo courtesy of Hermann Buss GmbH

Main switchboard in the Engine Control Room

Emergency switchboard – A switchboard which, in the event of failure of the main electrical power supply system is directly supplied by the **emergency source of electrical power** or the transitional source of emergency power and is intended to distribute electrical energy to the emergency services, (**SOLAS**).

Syncrolift – A ship lift consisting of an articulated platform: a series of transverse beams supported on each end by electro-mechanical hoists and connected longitudinally by non-rigid structural members. The platform is raised and lowered by a large number of synchronised wire drum winches arranged on each side of the dock. It is a relatively simple task to add length to the platform and only slightly more complex one is to add intermediate beams to increase the capacity. The platform is handled by a heavy rail system and accommodated in its own dock. The Syncrolift shiplift system was invented in 1954 by Raymond Pearson, the founder of Syncrolift Inc.

Synfuel – Synfuels can be produced from coal, natural gas, or biomass feed stocks through chemical conversion into syncrude and/or synthetic liquid products.

Tack weld – A weld made to hold parts of a weldment in proper alignment until the final welds are made.

Tack welder – A fitter, or someone under the direction of a fitter, who tack welds parts of a weldment to hold them in proper alignment until the final welds are made.

Tactical diameter – see **Manoeuvring parameters**.

Take-me-home drive systems – Emergency drive systems typically installed in ships with geared medium-speed engines by means of an electric motor connected via a clutch to a pinion shaft in the gearbox (PTI). In normal service the motor serves as a power take off (PTO) shaft generator.

The installation of an emergency drive system in a vessel fitted with low-speed propulsion requires a different solution, due to the high torque, high power, low rpm requirements of the engine.

An innovative take-me-home system was developed by Marinvest Engineering and marine designer Bo Bengtsson for a slow speed main engine on product tankers. It uses the hydraulic power from the Framo cargo system for emergency propulsion. If the main engine breaks down, a hydraulic drive package will be connected to the shaft line in 10-20 minutes.

Note:

Emergency drive systems designed for e.g. 6 knots in calm weather are not capable of propelling the ship in rough seas when they are really needed.

Tank – An enclosed space formed by the permanent structure of a ship and which is designed for the carriage of liquid in bulk. See also **Cargo tanks**.

Centre tank – Any tank inboard of a longitudinal bulkhead.

Slop tank – A tank specifically designated for the collection of tank drainings, tank washings and other oily mixtures.

Wing tank – Any tank adjacent to the side shell plating.

Tank Arrangement Plan (TAP) – A very important drawing that shows the position and the data of all ship tanks. To avoid misunderstandings, the TAP must contain a sufficient number of views and cross sections. It shall be framed and posted on the Bridge and in the Ship Office.

Each tank must be defined by a full name and a code which must be used in the same form on all drawings and in all ship documents. Codes must be short and will be welded on shell plating, manhole covers, etc. It is recommended to use standard tank names and codes. See also **Tank Space Information**.

Example of the Tank Table

No	Tank	Full Tank Name	Fr - Fr	V (m ³)	HFO (t)	MDO (t)	LO (t)	BW (t)	FW (t)	OT (t)	VCG (m)	LCG (m)	TCG (m)	Max FSM (tm)
1	2	3	4	5	6	7	8	9	10	11	12	13	14	15

Explanation of columns names

Ad. 1. Number of the row.

- Ad. 2. Code of the tank that shall to be used on all drawings, name plates, manholes, etc.
- Ad. 3. Full name of the tank.
- Ad. 4. Location of the tank.
- Ad. 5. Volume (m³) of the tank.
- Ad. 6. Mass of Heavy Fuel Oil, (HFO) with given specific gravity (t/m³).
- Ad. 7. Mass of Marine Diesel Oil, (MDO) with given specific gravity (t/m³).
- Ad. 8. Mass of Lubrication Oil, (LO) with given specific gravity (t/m³).
- Ad. 9. Ballast Water, (BW) with given specific gravity (t/m³).
- Ad. 10. Fresh Water, (FW) with given specific gravity (t/m³).
- Ad. 11. Other Tanks, (OT).
- Ad. 12. Vertical Centre of Gravity from Base Line (m).
- Ad. 13. Longitudinal Centre of Gravity from After Perpendicular (m).
- Ad. 14. Transverse Centre of Gravity from Centre Line (m).
- Ad. 15. Maximum Free Surface Moment (tm).

Tank cleaning – The process of removing hydrocarbon vapours, liquids or residues. Tank cleaning may be required for one or more of the following reasons:

1. To carry clean ballast.
2. To gas free tanks for internal inspections, repairs or prior to entering dry dock.
3. To remove sediments from tank top plating. This may be required if the vessel is engaged in the repetitive carriage of fuel oil or similar sediment settling cargoes. Although washing may not be necessary in between consecutive voyages, assuming the cargoes are compatible, many Ship Owners have found it prudent to water wash a small group of tanks on a rotation basis between voyages, thus preventing any large accumulation of sediments.
4. To load a different and not compatible grade of cargo.

Washing in between carrying different grades of cargo is the most common reason for tank cleaning. In most cargo sequences on product tankers, the cleaning may consist of no more than a simple hot or cold seawater wash. A simple water wash will disperse many types of chemicals and has been found effective between clean petroleum products such as gasoil and kerosene. However, it should be noted that there is a number of grade sequences, particularly in the petroleum product trade, where no washing at all needs to be carried out. Thus the decision for necessary tank cleaning required in such trades is often made only when knowledge of the next grade to be loaded is obtained.

Tank cleaning machines – see **Washing machines**.

Tank cleaning validation (TCV) system – The software package for the monitoring of tank cleaning, developed by Toftejorg A/S. The system provides data reports for port authorities and statistics that help to optimise the cleaning technique. A signal from each cleaning machine to the control computer indicates its idle or operating status on a screen along with the cargo level in each tank. The TCV system can also be applied for logging the running hours of each machine, useful in planning preventive maintenance.

Tank cover – The protective structure intended to protect the **cargo containment** system against damage where it protrudes through the weather deck or to ensure the continuity and integrity of the deck structure, (**IGC Code**).

Tank dome – The upward extension of a portion of a cargo tank. In case of below-deck **cargo containment system**, the tank dome protrudes through the weather deck or through a tank cover, (**IGC Code**).

Tank Space Information

Tank Space Information - As built documentation of tanks. It shall consist of the following documents:

1. Drawing "TANK ARRANGEMENT PLAN" (TAP)
The TAP is the main drawing which all other documents must follow. It should be framed and posted on the Bridge and in the Ship Office.
2. Booklet "TANKS"
A booklet of A4 format with some A3 pages showing tanks arrangement. The booklet TANKS must be a part of the stability documentation, Ballast Water Management Plan, Capacity Plan, etc.
3. Booklet "TANK SCALING TABLES FOR MANUAL SOUNDING".
4. Booklet "TANK SCALING TABLES FOR REMOTE SOUNDING".

Tank support system for high-temperature cargoes – A special tank support arrangement for use on board product tankers used for carrying asphalt, coal tar and **molten sulphur** at high temperature. These cargoes are carried in individual insulated tanks, each of them resting on multiple supports in the hull. The tanks cannot be fixed directly to the ship hull due to the stresses encountered because of temperature differences between the cargo and seawater.

TANKERS

Tankers are ships carrying liquid cargoes in bulk; **crude oil**, oil products, chemicals, liquefied gases, molten sulphur, even orange juice. The nature of their cargo requires special forms of construction and outfitting. Some cargoes, as liquefied gases, are transported at very low temperatures down to -164°C , others as molten bitumen, must be transported at high temperatures up to 250°C in independent tanks supported by means of special methods.

Tankers can be divided into the following types: **oil tankers**, **chemical tankers**, **gas carriers** and combination carriers.

Crude oil tanker is an oil tanker engaged in the trade of crude oil. **Product tanker** is an oil tanker engaged in the trade of oil other than crude oil. A clean product tanker carries light petroleum products, a dirty product tanker carries heavy petroleum products. The product tanker is intended for transportation and distribution of crude oil derivatives from the refineries to consumers. The main difference between a product tanker and a crude carrier is, that with the former, several batches of cargo of different kinds are transported simultaneously and the respective cargo quantities are smaller. It requires a large number of cargo tanks and a complicated pumping and piping system to facilitate a separate handling process for each type of cargo.

High heat tankers are product carriers for the transportation of molten sulphur, bitumen, dirty petroleum products, coal tar, pitch and coal tar products. They maintain a cargo temperature between the ranges of 160°C and 240°C , which places very heavy demands on the heating, insulation of the tanks and pipework, as well as associated valves and pumps. See also **High heat tanker BITFLOWER**.

Chemical tankers are ships constructed to carry a cargo of noxious liquid substances in bulk. There are two kinds of chemical tankers: one is an exclusive chemical tanker for carriage of an exclusive cargo, and the other one is a **parcel chemical tanker** capable of carrying many kinds of chemical cargoes. The two distinct categories of chemical tanker comprise

TANKERS

Photo: P-H. Sjöström



4634dwt oil/chemical tanker STOC MARCIA
 $L_{BP} = 94.04\text{m}$, $B_{mld} = 15.00\text{m}$, $D_{mld} = 7.40\text{m}$, $d = 6.00\text{m}$

STOC MARCIA can carry dirty products such as tall oil and coal tar, but also petroleum and chemical products. The Wärtsilä 6L32 main engine has an output of 3000kW.

Photo: J. Sjöström



16 600dwt product carrier NAKSKOV MAERSK
 $LBP = 133.0\text{m}$, $B = 23.4\text{m}$, $d = 8.40\text{m}$

The vessel is provided with Wärtsilä Sulzer 6RT-flex 48 main engine with MCR = 6300kW.

Target useful life (painting)

vessels with all or most of the cargo tanks fabricated from stainless steel, and those vessels embodying only coated, mild steel tanks. See also **Chemical tanker BOW SUN**.

Gas carriers are intended to carry different liquefied gases used for energy purposes (petroleum gases, natural gases), in the chemical industry (ethylene, vinyl chloride, propylene, etc.) or used as a raw material for making agricultural fertiliser (ammonia).

Parcel chemical tanker – A chemical tanker capable of carrying many kinds of chemical cargoes including petroleum products.

Chemical parcel tanker STOLT INNOVATION has 42 integral stainless steel cargo tanks and 4 deck tanks. The smallest is around 350m³, while the biggest is approximately 2050m³. The maximum temperature that can be maintained in the tanks is 95 deg C, while the lowest is around 15 deg C. Each tank has a separate piping system which connects the tank to the manifold discharge/loading area. Altogether, there are 40km of piping on the vessel.

Target useful life (painting) – The target value, in years, of the durability for which the coating system is designed.

Tarpaulin – A waterproof canvas covering for a hatch or other purpose.

Taut wire system – The method of position finding which gives the position from the angle of a taut wire towards the davit.

Technical Data Sheet (painting) – Paint manufacturers' Product Data Sheet which contains detailed technical instruction and information relevant to the coating and its application.

Technical file of an engine – A record containing all detailed parameters, including components and settings of an engine, which may influence the **NOx emission**, in accordance with the **NOx Technical Code**.

According to IMO regulations, a Technical File shall be made for each engine. This Technical File contains information about the components affecting NOx emissions, and each critical component is marked with a special IMO number. Such critical components are the injection nozzle, injection pump, camshaft, cylinder head, piston, connecting rod, charge air cooler and turbocharger. The allowable setting values and parameters for running the engine are also specified in the Technical File.

The marked components can later, onboard the ship, be easily identified by the class surveyor and thus an International Air Pollution Prevention (IAPP) certificate can be issued.

Telecommunications cable – It comes in a variety of sizes ranging from 10mm to 80mm in diameter. Due to its inherent nature, the cable, especially in smaller diameters, is easily damaged. The radius that the cable can be bent to is usually restricted to a minimum of 1.5m. It usually comprises shorter sections connected by joints that can be up to 250mm diameter and 1.5m length. Depending upon the system installed it may have signal amplifiers (repeaters) between 20 and 180km in between sections. They can be up to 350mm in diameter and 3m in length and usually have to be cooled to below 30°C.

Tempering – A type of steel heat treatment. The process follows the quenching of steel and involves reheating up to temperature of 680°C. The higher the tempering temperature, the lower the tensile properties of steel. Once tempered, the metal is rapidly cooled by quenching.

Template – A full-size pattern from which an item can be made, e.g. a pipe or steel plate.

Tensile strength – The ability of a material to withstand tensile stress, i.e. a force attempting to lengthen the material, divided by the material area.

Tensile test – A test to determine the material strength and ductility. A specially-shaped specimen of standard size is gripped in a testing machine and the ends drawn apart. The deformation of the specimen for different loads, i.e. the strain, can be found. A graph of stress against strain can then be drawn.

Tension leg platform (TLP) – see **OFFSHORE PRODUCTION AND STORAGE INSTALLATIONS**.

Terminal – Any structure used for the assembly, processing, embarking, or disembarking of cargo. It includes **piers**, wharves, and similar structures to which a ship may be secured; land and water under or in direct proximity to these structures; buildings on or contiguous to these structures; and equipment and materials on or in these structures.

Terminal/escort tug LAMNALCO SANA'A

According to the **Significant Small Ships** of 2009

LAMNALCO SANA'A is the high-performance ASD tug built to the RAstar design developed by Robert Allan Ltd., naval architects of Vancouver, B.C.



The principal particulars of this RAstar 3600 Class tug are: Length, OA: 35.80m, Beam, moulded: 14.50m, Depth, moulded: 6.03m (above design baseline), Maximum operating draft: 6.50m (to underside of drives), Bollard pull, ahead/astern: 118t/110t maximum, Free running speed, ahead: 15.1 knots, Lightship mass: 963t.

The RAstar design hull form incorporates a significant sponson on the upper hull sides. When the tug is heeled over under influence of the towline during an escort operation, the “downhill” sponson is submerged and a large righting force is generated to improve the stability, thus increasing the towline force. In addition, the hull has a large foil-shaped skeg, also designed to increase indirect towline forces. The RAstar hull form also provides dramatic reductions in roll amplitude and roll accelerations, thus providing a safer and more comfortable platform for crews, who are now being asked to conduct docking operations at LNG terminals and similar installations in up to sea-states of 3.0m significant wave heights.

Terminal representative

This powerful escort tug is equipped for typical ship-handling and escort work, with a double drum hawser winch on the fore deck, with a capacity for each drum of 300m of 64mm diameter plus 150m of 80mm synthetic hawser. The escort-rated winch is driven by a twin-pump electro-hydraulic set, and features a two speed drive system, capable of line recover/rendering at 50t line pull at 20 m/min, or 16t at 60 m/min (first layer).

The aft deck is fitted with a heavy duty towing winch, fitted with 750m of 52mm diameter SWR, with a brake capacity of 150t. The aft deck is also fitted with pneumatic towing hook with rated load of 100t and a large knuckle boom crane.

Accommodations are to a very high standard for a crew of up to ten persons. Two spacious officer's cabins on the main deck have private en-suite facilities each, as well as two of the four double cabins below deck also have private en-suite facilities. The fully equipped galley serves a large common lounge/mess area, equipped with the latest video and audio entertainment systems.

Attention was paid throughout the design process to mitigating the propagation of noise and vibration through the essential resilient mounting of the main engines, isolation of all exhaust system components, and the extensive use of visco-elastic floating floor systems throughout. The wheelhouse is designed to provide maximum all-round visibility from a single split type master console.

The LAMNALCO SANAA is built in accordance with Bureau Veritas regulations for a 1+ Hull, +Mach X Escort Tug, Fire Fighting Ship 1 with water spray, AUT UMS, unrestricted service. The main propulsion components include two Wärtsilä 9L26 engine rated at 3060kW at 1000 rpm at 100% MCR and two Wärtsilä Z-Drives. Electric power is developed by three 315kW diesel gensets, and by a third harbour/emergency gen-set, rated at 90kW.

The fire-fighting capability is provided by a pair of FFS main-engine driven pumps, each rated 1378 m³/h, which serve a pair of FFS-1200SB water/foam monitors, each rated at 1200 m³/h, and the self-protection waterspray system.

Terminal representative – A person appointed by the terminal or other facility where the ship is being loaded or unloaded. He has the responsibility for operations conducted by the terminal or facility with regard to the particular ship.

“The terminal representative should follow the agreed unloading plan and should consult the master if there is a need to amend the plan.”

Test cock – A valve from which a sample can be drawn for testing or visual examination, e.g. salinometer cock on a boiler or test cock on an **oily water separator**.

Thermal conductivity – A measure of the heat flow rate through a material. The specific value is calculated as the quantity of heat flowing through a unit area of unit thickness in one second when the temperature difference between the faces is one degree. The unit is watts per metre kelvin.

Thermal efficiency – The ratio of the work done by an engine to the mechanical equivalent of the heat available in fuel.

Thermal protective aid – A lightweight waterproof garment intended to conserve body heat and be worn by persons suffering from exposure to cold temperatures, e.g. a person recovered from the sea.

Thermal trip – A device which is operated by a rise in temperature. It is used on circuit breakers, relays, etc., and is often a bimetallic strip which deflects when heated.

Thermoplastic – Any plastic material which can be softened under the application of heat or heat and pressure and then hardened by cooling, without any changes in its properties, e.g. polyvinyl chloride (PCV), nylon.

Thermostat – A device which responds to temperature changes. It may act as a valve in the water cooling circuit of small engines. It may be used in electric circuits to function as a switch.

Thinner – Volatile liquids added to paints to speed up application and to support penetration by lowering the viscosity.

Third Assistant Engineer – Licensed member of the engine department, in charge of the eight to twelve watch. He maintains lighting fittings. Repairs malfunctioning accessories in living quarters. Assist other engineers as directed.

Third Mate – The licensed member of the deck department, in charge of the eight to twelve watch. He makes sure that the emergency survival equipment (**lifeboats, liferafts**, etc.) are in order. He assists other officers as directed.

Threshold – The value of input to a measuring instrument, or any system, below which no output change can be detected.

Threshold limit value (TLV) – The time-weighted average concentration of a substance to which workers may be repeatedly exposed, for a normal 8-hour workday or 40-hour workweek, day after day, without adverse effect.

Throat of a fillet weld –

Actual throat – The shortest distance between the weld root and the face of a fillet weld.

Theoretical throat – The distance from the beginning of the joint root perpendicular to the hypotenuse of the largest right triangle that can be inscribed within the cross section of a fillet weld. This dimension is based on the assumption that the root opening is equal to zero.

Thrust bearing – A bearing located inside the ship to transmit the propeller thrust from the shafting to the hull structure.

The thrust bearing consists of a thrust collar on the crankshaft, a bearing support, and segments of steel with white metal. The propeller thrust is transferred through the thrust collar, the segments, and the bedplate to the engine seating and end chocks.

Thrust block – The complete assembly of thrust shaft and bearings which is solidly constructed and mounted onto a rigid seating. It will transfer the propeller thrust into the structure of the ship in order to bring about propulsion.

Thrust power – The product of the propeller thrust and speed of vessel advance.

Thrust shaft – A short length of shaft with flanges at either end and a thrust collar in the centre. It may be manufactured as an integral part in some engines.

Thruster system of dynamic positioning system – All components and systems necessary to supply the DP system with thrust force and thruster direction. The thruster system includes:

- thrusters with prime movers and necessary auxiliary systems including piping,
- main **propellers** and **rudders** if they are under control of the DP-system,
- thruster control electronics,
- manual thruster controls,
- associated cabling and cable routing.

Thrusters – Manoeuvring devices designed to deliver side thrust or thrust through 360°. Thrusters are used to allow ships to be more independent from tugs, give them more

WÄRTSILÄ AZIMUTHING THRUSTERS

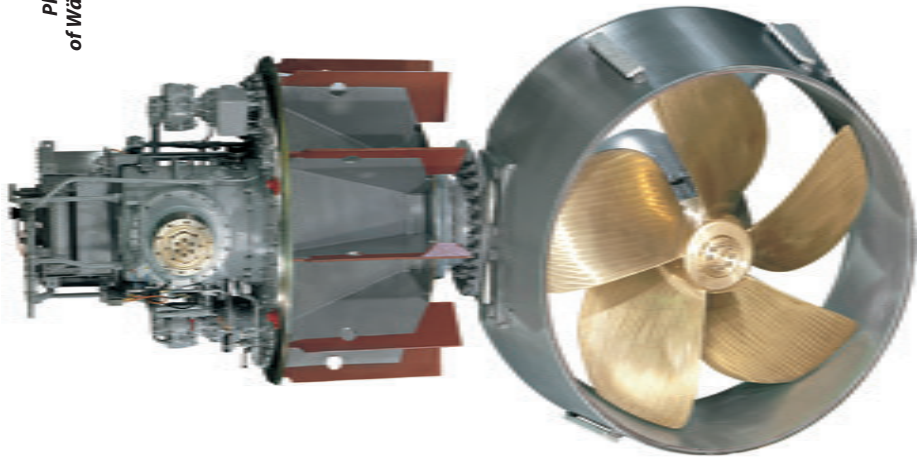

*Photos courtesy
of Wärtsilä Corporation*

2000kW Wärtsilä Lips Modular thruster FS250

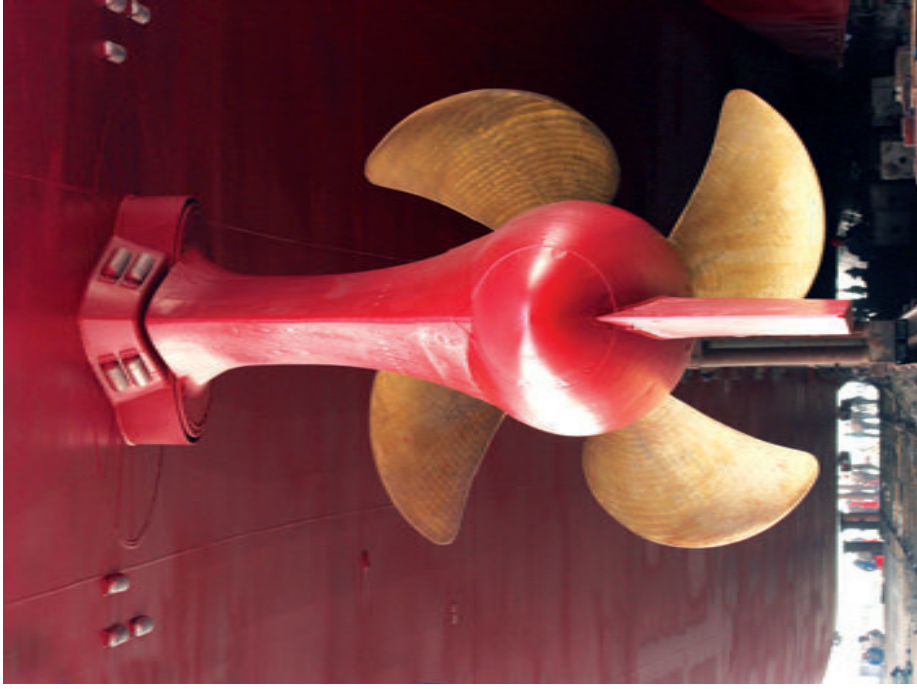

Wärtsilä Lips pulling thruster

WÄRTSILÄ RETRACTABLE THRUSTER

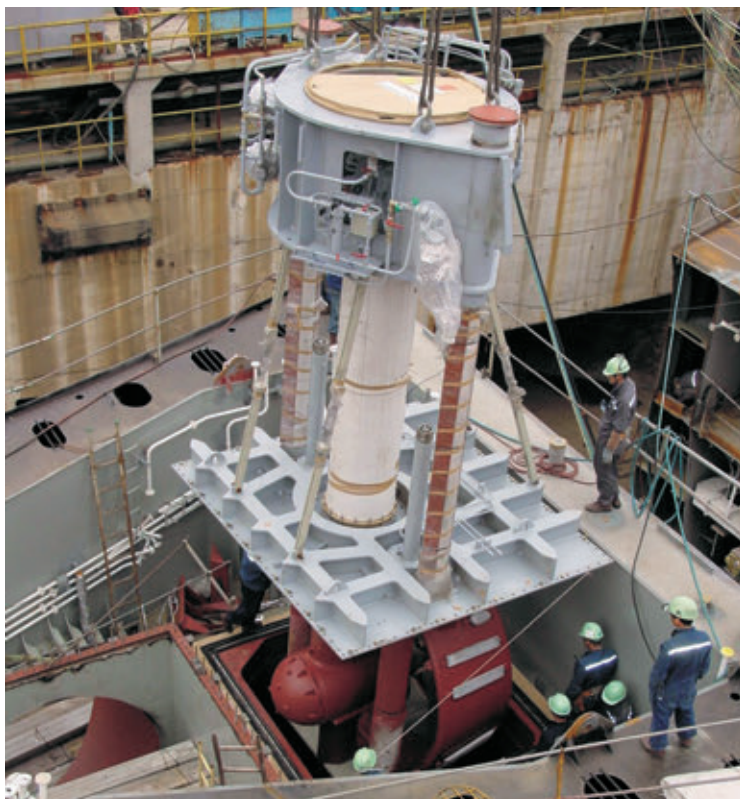

Installing 1200kW retractable thruster

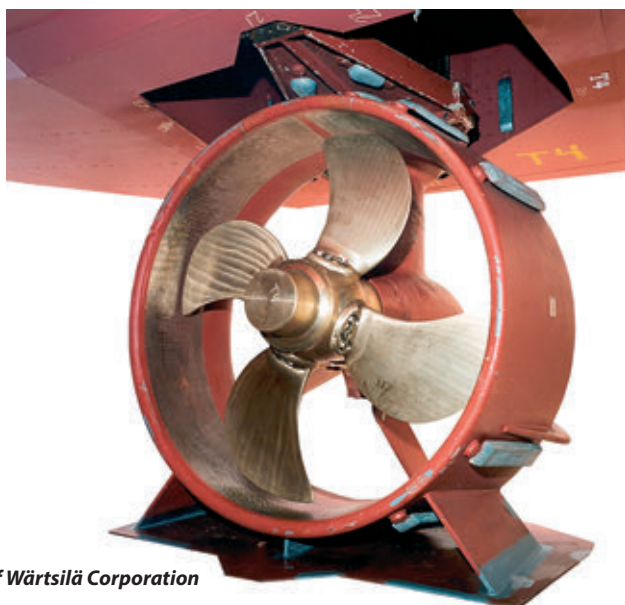

Photos courtesy of Wärtsilä Corporation

manoeuvrability for special tasks, and in some cases give them a “take home” capability. There are three general types of thrust devices: the **lateral thruster** or tunnel thruster, which consists of a propeller installed in an athwartship tunnel; a **jet thruster** which consists of a pump taking suction from the keel and discharge to either side; and azimuthal thruster, which can be rotated through 360°. A **cycloidal propulsor** can be considered a type of azimuthal thruster.

Thrusters can enhance the manoeuvrability of existing vessels, particularly at low speeds, and provide a high level of redundancy. The main propulsion system based on thrusters can also provide increased speed, or lower installed power and reduction in fuel consumption. The general arrangement and hull form of new buildings incorporating thrusters can be modified significantly in order to increase hydrodynamic efficiency. The other key advantage of thrusters is that they tend to suffer less from vibration and noise and are therefore well suited for use on passenger vessels. Since thrusters are steerable, using them may also eliminate the ship rudder.

Azimuthing thruster – A propeller that can be rotated through 360° in the horizontal plane, thus allowing the thrust to be generated in any desired direction.

Continuous duty thruster – A thruster designed for continuous operation, such as dynamic positioning thrusters, propulsion assistance, or main propulsion units.

CRP thruster – An azimuthing thruster equipped with twin contra-rotating propellers.

Intermittent duty thruster – A thruster which is designed for the operation at the peak power or rpm levels, or both, for periods not exceeding 1 hour followed by periods at the continuous rating of less, with total running time not exceeding 8 hours in 20 hours. Generally, such thrusters are not meant to operate for more than 1000 hours per year.

Jet thruster – A pump arranged to take suction from beneath or close to the keel and to discharge to either side, to develop port or starboard thrust, or in many cases through 360°.

Lateral thruster, transverse thruster, tunnel thruster – A propulsion device fitted to certain types of ships to improve manoeuvrability. The thrust unit consists of a propeller mounted in an athwartships tunnel and provided with some auxiliary drive such as an electric or hydraulic motor. During operation, the water is forced through the tunnel to push the ship sideways either to port or starboard as required. This type of thruster is usually installed at the bow (bow thruster), and sometimes at the stern (stern thruster).

Outboard thruster – In operation the stern-mounted outboard thruster is similar to an outboard engine on a speedboat, and is capable of being lifted out of the water for easy maintenance and to reduce drag while underway.

Retractable thruster – A thruster able to be pulled up or in. A thruster able to be pulled up or in to reduce drag when vessel is in a transit mode, or reduce depth of vessel when transiting or operating in shallow water.

Rim drive thruster – A revolutionary compact lateral thruster developed by two partnerships: Rolls-Royce with Smartmotor from Trondheim, and Van der Velden® Marine Systems with Combimac (The Netherlands). The electrical motor has the form of a thin ring. Its stator is incorporated in the tunnel and its rotor carries propeller blades. Waterflow through the unit is unobstructed since there is no gearbox in the tunnel, nor are struts needed to support a hub. Together these factors give a high total efficiency and reduced noise and vibration.

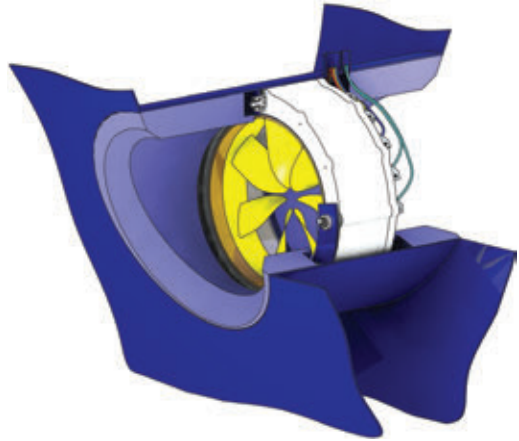
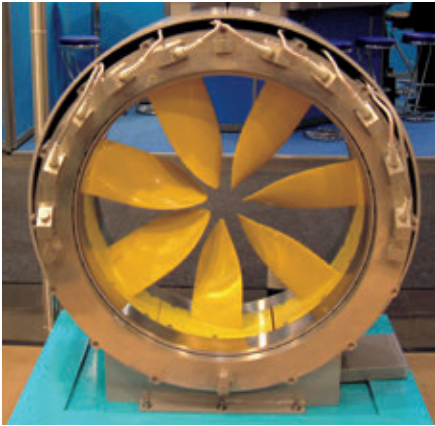

Rim drive thruster of EPS™ type from Van der Velden® Marine Systems

Swing-up azimuth thruster – A dual-function unit, supplementing an azimuthing function with a tunnel thruster role when the unit is in the raised position and recessed within the hull. The transverse tunnel-shaped recess is oversized to allow the thruster to rotate through 180° to provide thrust to port or to starboard. In this way, the propeller thrust is always in the same direction and therefore, the propeller blades can be designed with optimum camber and radial pitch distribution.

Titled thruster – Wärtsilä developed new type of steerable thruster with a downward tilted propeller shaft. The 82° gearbox deflects the jet sufficiently downward to minimize hull-interaction effects, thus improving thruster efficiency.

An example case has been analysed of a rig with 8 thruster units. The maximum increase of available thrust of the rig in side way operation is about 35%. In forward operation the gain in available thrust is 9%. The improved vessel performance is attributed to the significantly reduced interaction losses with the hull and with other thruster units.

Thyristor – A device which conducts current in one direction and can be switched into the conducting state when a voltage of correct polarity is supplied to its main terminals and a trigger signal is applied to a gate terminal.

Tidal energy – Tidal energy is produced by the surge of ocean waters during the rise and fall of tides. Tidal energy is a renewable source of energy.

Tightness test – An air test or other medium test carried out to demonstrate the tightness of the structure.

Air test – A test to verify the tightness of the structure by means of air pressure difference.

Chalk test – A test for weathertightness of the hatch covers or doors. It uses chalk rubbed on the compression bar to imprint on the seal.

Hose test – A test to verify the tightness of the structure by a jet of water. It is usually applied for hatch covers, doors and windows.

Hydropneumatic test – A combination of hydrostatic and air testing consisting in filling the tank with water up to its top and applying an additional air pressure.

Hydrostatic test – A test to verify the structural adequacy of the design and the tightness of the tank structure by means of water pressure. The test employs the filling of the tank with water according to Rules requirements, usually up to the top of overflow or 2.4m above the highest point of tank.

Notes from BNC Leak Tests Program:

1. Where one tank boundary is formed by the ship shell, the leak test is to be carried out before launching.
2. If this is impossible, manually made butt welds on the ship shell can be tested by vacuum box before launching. Butts shall be not coated. Remaining welds can be leak-tested after launching.
3. For tanks without boundary formed by the ship shell, the leak testing may be carried out after launching.
4. Leak tests are to be carried after all attachments, outfitting, or penetration, which may affect the strength or tightness, have been completed, and before any ceiling and cement work is applied over joints. If after the leak test any hot work was carried out in the tank, the leak test shall be repeated. The procedure shall be agreed with Class Surveyor and Owner's Inspector.
5. Watertightness of welds, which are not subject to air testing, should be checked by chalk and kerosene test at the section fabrication stage.
6. Bottom drain plugs shall be checked by a dye penetrant test at the section fabrication stage.
7. Welds shall be cleaned and all damages to the tank boundaries, if any, shall be repaired before the leak tests.
8. If it is ensured that in adjacent tanks, the same type of liquid is carried, e.g. in adjacent ballast tanks, the erection welds as well as welds of assembly openings may be coated prior to the leak test. Otherwise these welds are to be coated after the leak test is carried out.
9. Shopprimers are not regarded as a coating within the scope of the leak tests.
10. It is not allowed to repair leaking welds when the tank is kept under pressure.
11. After launching, hydrostatic tests of few representative tanks shall be carried out to verify the structural adequacy of the design. Tanks to be selected so that all representative structural members are tested for the expected tension and compression.
12. Hydrostatic tests may be carried out for the first vessel only.

Tiller – An arm, attached to **rudderstock**, which turns the **rudder**.

Timber – Sawn wood or lumber, **cants**, logs, poles and all other types of timber in loose or packaged forms. The term does not include wood pulp or similar cargo. Storage factors vary widely, from 1.5 m³/t for packaged lumber to 3.0 m³/t for logs.

Timber deck cargo – A cargo of timber carried on an uncovered part of freeboard or the **superstructure** deck. The term does not include wood pulp or similar cargo.

The height of the timber deck cargo above the weather deck on a ship within a seasonal winter zone in winter should not exceed one third of the extreme breadth of the ship.

Timber load line – A special load line assigned to ships complying with certain conditions related to their construction set out in the International Convention on Load Lines and used when the cargo complies with the stowage and securing conditions of the Code of Safe Practice for Ships Carrying Timber Deck Cargoes.

Tin – A ductile, malleable metal, resistant to corrosion. It can be used as a coating for steel and also in various alloys.

Titanium – A light, strong, corrosion resistant metal which is used as the plate material in plate-type heat exchangers. It is also used as an alloy element in various special steels.

T-joint – A joint between two members located approximately at right angles to each other in the form of a T letter.

Toeboard – A barrier placed along the edge of a walking surface to prevent personnel from placing their feet over the edge of an elevated walking surface. It should also prevent objects from sliding or rolling over the edge onto personnel below.

Tolerance – The variation permitted in a dimensional size, position, form, etc., of a component.

Tonnage –

Gross tonnage – Under vessel measurement rules of various nations, the Panama Canal and the Suez Canal gross tonnage is a measure of the internal volume of space within a vessel in which 1 ton is equivalent to 2.83 cub m or 100 cub ft. Under the International Convention on Tonnage Measurement of Ships, 1969, (ICTM), a standardized numerical value is a logarithmic function of spaces within a vessel. There is no definition of a ton under ICTM because the value per unit of volume is greater on a vessel of large volume than on a vessel of small volume. Gross tonnage according to the national and canal rules generally includes spaces bounded by the under surface of the uppermost complete deck, the side frames, and the floor frames or the inner bottom if it rests on the floors or if the double water is for water ballast, plus closed-in space in deck structures are available for cargo or stores or for the berthing or accommodation of passengers or crew. Rules vary greatly as to exclusion or inclusion of various spaces. Gross tonnage according to ICTM is $GT = K_1 V$ in which V is the total moulded volume of all enclosed spaces of the ship in cub m and K_1 is $0.2 + 0.02 \log_{10} V$.

The use of gross tonnage as a criterion for charging port and other dues, and the efforts of designers make it minimal, leads to the whole range of undesirable features in ship design.

Net tonnage – Net tonnage according to the national and canal rules is derived from gross tonnage by deducting an allowance for the propelling machinery space and certain other spaces. Net tonnage according to ICTM is a logarithmic function of the volume of cargo space, the draft-to-depth ratio, the number of passengers to be accommodated, and the gross tonnage.

Top drive – A large electrically- or hydraulically-powered motor suspended from the travelling block and connected directly to the drill string.

Topping off – The operation of completing the loading of a tank to a required **ullage**.

Topping up – The introduction of **inert gas** into a tank which is already in the inert condition with the object of raising the tank pressure to prevent any ingress of air.

Toppling – The tendency of a container to pivot on its bottom edge and eventually to overturn when subject to extreme rolling motions of the ship.

Torsion – The strain set up onto a member which is twisted without bending.

Torsional vibration – The twisting of a shaft or any other structure about an axis in a cyclical manner due to a varying applied torque. If the **frequency** of the applied torque is the same as the natural frequency of the vibrated body, then resonance will occur. In an engine, this would be a critical speed.

Total head – The difference in pressure between the suction and discharge branches of a pumping system, which is required to produce a flow of liquid. It is expressed as the height of a column of liquid.

Total static head – The vertical height of a stationary column of liquid produced by a pump, measured from the suction level.

Total loss (marine insurance) – A ship having ceased to exist after a casualty, either due to being irrecoverable (actual total loss) or due to being subsequently broken up

Towing and anchor handling equipment of TOR VIKING

(constructive total loss) (LMIS, 1995). The constructive total loss occurs when the cost of repair exceeds the insured value of the ship.

Towing and anchor handling equipment of TOR VIKING

According to **The Motor Ship** September 2000

The icebreaking/offshore support vessel TOR VIKING is fitted with a Rauma Brattvaag waterfall winch of 400t pull and 550t brake holding load ratings. A single declutchable towing and anchor handling drum with a dividing flange has a wire capacity of either two 1900m lengths of 77mm diameter wire or two 1650m long 83mm diameter wires.

Another drum for anchor handling has the capacity for 4100m of 83mm diameter wire. Two cable lifters can be adjusted to suit a range of chain diameters, and the rig chain lockers can accommodate two 1832m lengths of 3-inch chain.

The operation of the winch is via Rauma Brattvaag's Towcon 2000 control system which features a facility for printing out statistical towing data. A continuous forward **bollard pull** of 202t, with around 120t pull astern, is available. Two rope reels, a stern roller (3.5m diameter x 6m long) with a working load rating of 500t vertically, and two sets of Karm Fork shark jaws and towing pins, supplement the main winch.

Towing gear – Towing winches, hawser winches, towing hooks, tow bits.

Towing gear of the Rotor tug RT INNOVATION

The towing gear includes a "waterfall"-type hydraulic main **towing winch** with three declutchable drums. The full width upper drum accommodates 650m of 56mm diameter steel wire rope, with a 20m Nylon (spring) of 100mm diameter. Each lower drum, used for ship-handling, carries 200m of 56mm steel wire rope, with a 10m Nylon spring and 48mm diameter steel wire pennant. On the foredeck, there is a combined towing winch and an anchor windlass. The winch has a single drum, for a 200m towline with the necessary spring and pennant, two declutchable chain lifters, and two fixed warping heads. Both the towing winches have pneumatic controls and can be operated remotely from the wheelhouse or from small control consoles on deck. A quick release **towing hook** is fitted for the secondary use.

Towing gear of the standard type tug SAAM MEXICA

A disc-type **towing hook** with a **safe working load** of 65 ton, is fitted together with a double pole towing bitt on the aft deck. The towing hook is provided with a quick release device which can be operated from the **wheelhouse** and from two local stations on the aft deck. A 10ton hydraulically-driven towing winch with a hauling speed of 10m/min is fitted on the aft deck and carries 200m of steel wire.

Towing hook – A device created primarily to enable a quick connection to a tow, and secondly to reduce the heeling moment on the tug during ship handling. The towing hook is to be fitted as low as possible.

Towing hook slipping device – A device which enables slipping of the hook in case of emergency.

Towing pins, also guide pins – A pair of hydraulic posts used to contain the work wire or mooring chain within a restricted area at the stern of AHTS vessels. They are lifted from the deck and trap the wire inbetween themselves, some of these having plates on the top (elephant's feet) which turn inwards, preventing the wire from escaping. Angled guide pins makes extra locking mechanism on top of pins unnecessary: when both pins are raised they close completely together at the top.

Towing tank – A long, top-opened tank of a rectangular cross section equipped with a towing carriage that runs on two rails on either side. The towing carriage can either tow the model or follow the self-propelled model and is equipped with computers and devices to register or control speed, propeller thrust and torque etc.

The towing tank of HSVA enables such tests as: resistance, propulsion and tracking tests, horizontal planar motion testing, flow observation (paint and underwater TV), wake measurements (axial or 3-d laser velocimetry), propeller open water tests, seakeeping tests (in regular or irregular waves), measurement of forces and pressures acting on hulls or offshore structures, rolling tests, mooring tests.

Towing winch – A device which controls the steel towline connecting the tug to its tow. It must be designed to transmit the full dynamic towing load to the tug hull, yet be ready to release in a moment in emergency.

Toxic fluids – Fluids liable to cause death or severe injury or harm to health if swallowed or inhaled or absorbed by skin.

Tracking – The process of observing the sequential changes in the position of a target in order to establish its motion.

Trackways – The rails fitted to the coaming with hatch cover wheels running on them.

Traditional fuel injection – Mechanically-controlled fuel injection. Each engine cylinder has its own fuel injection pump and all the fuel is fed directly into the cylinder.

Trailers –

Air shuttle trailer – A trailer designed by Wallenius Wilhelmsen for transport of fully assembled railcars. Fitted with rails on top, the air shuttle has a pneumatic system that can lower the trailer bed to the ground. This enables direct transfer of railcars from rail tracks to the air shuttle trailer via a ramp.

Jack-up trailer, also cometto trailer – A trailer built to carry exceptionally heavy cargo weighing several hundred tons. A jack-up trailer consists of four-axle sections that can be configured to carry cargo of almost any size and weight.

Roll trailer, also mafi trailer – A low platform for the carriage of cargo with one or more wheel axles at the rear and a support at the front end which is towed or pushed in the port to and from its stowage on board the ship by a special tow-vehicle. The terminal tractor uses a detachable gooseneck to lift the forward end and transfer the roll trailer onboard.

Samson heavy-lift trailer – A trailer designed by Wallenius Wilhelmsen for small and medium-sized lifts, such as transformers, generators and turbines.

Trailing suction hopper dredger VASCO DA GAMA

According to **HANSA** June 2000

The trailing suction hopper dredger VASCO DA GAMA is designed to recover sand from the sea, haul it for long distances and place it ashore. With a massive hopper capacity of 33,000 m³, the vessel was the largest dredger in the world at the time of delivery.

Dredging equipment

The vessel is equipped with two 1400mm trailing suction pipes. Her standard configuration provides for working to depths of 45m and 60m. However, the vessel has been prepared to enable the starboard pipe to be extended for operations at 80m or 125m dredge

depths. Each suction pipe consists of an upper part with trunnion and a lower part with a draghead, moving freely with respect to each other and to the hull. For dredging, the pipes are lifted by three cranes each: one at the draghead, one at the trunnion and one at the intermediate cardanic joint of the upper and lower suction pipe part. To compensate for draghead movements due to uneven seabed and the ship motion due to waves, a swell compensator is installed. The installation compensates for relative motions of up to 8 metres.

Two dredge pumps are the heart of the dredging equipment, driven by the main diesel engines via three-speed gear boxes. They feature an extremely wear resistant alloy called "white iron metal" and a special sealing arrangement requiring water sealing only on the shaft side of the pump. During dredging, the pumps draw spoil from two side suction pipes, with a power of about 4500 kW.

Loading

From the dredge pumps, the mixture is directed to the hopper and distributed through a common 1600mm pipe arranged centrally on top of the hopper. The load is distributed in the hopper through three loading boxes to facilitate settling of sand in the hopper. A poor mixture discharge line ensures that only the mixture with sufficient spoil content is directed to the hopper.

The hopper is provided with four overflows, hydraulically adjustable in their height by remote control for drainage of excess water from the hopper through the ship bottom. The hopper is open at the top and has sloped void wings tanks enhancing the ship stability. To prevent spillage when the hopper is fully laden, a splash coaming is provided.

Discharging

The hopper is equipped with a central row of bottom doors for spoil dumping. The sides of the hopper bottom are sloped, to facilitate spoil inflow to the bottom doors or to the self-emptying channels located besides the bottom doors. To facilitate dumping in shallow water, where parts protruding beneath the ship's bottom might be damaged, all bottom doors are placed in recesses.

Dredge pumps are used for discharging. They draw spoil from two self-emptying channels in the hopper bottom. The channels extend from a fore sea chest to the pump room aft, and are equipped with twelve upper doors each. The mixture is removed from the hopper by opening the upper doors which are hydraulically-operated and controlled from the **wheelhouse**.

For shore discharge a floating pipeline of 1100mm diameter can be connected to the ship mixture pipe system at a bow coupling on the foreship. From the hopper via the dredge pumps, the mixture is then directly pumped to a discharge site on shore through the floating pipeline. The pumps can be operated in series for self-unloading at 8000 kW each, with a maximum pressure of 20 bar at the second pump. In result, the material can be transferred over distances as great as 8km without the need for boosters. The mixture can be also jetted forward over the ship bow via a mixture jetting nozzle.

Jet system

To fluidise the mixture in the hopper for discharging and for serving the draghead, three jet water pumps are installed, two high pressure pumps aft and one low pressure pump fore. The high pressure jet water pumps are driven directly by the auxiliary diesel engines, via two-speed gear boxes and couplings. The low pressure jet pump is electrically driven. The jet

water system supplies pressure water of up to 18 bar to the draghead for loosening the soil. For this purpose, both high pressure pumps are working in series. The system also supplies water to the nozzles arranged in rows in the hopper bottom, around the bottom doors and adjacent to the upper doors of the self-emptying channels.

Length oa: 201m, Length bp:178m, Breadth mld: 36.20m, Design draught:13m, Dredging draught: 14.6m, Deadweight at 14.50m: 60,000t, Hopper capacity: 33,000m³, Main engines: 2 x 14V48160, each 14,700kW/500rpm, Dredge pumps: 2 x 8000kW, Bow thrusters: 2 x 1650kW, Stern thrusters: 2 x 750kW, Classification: Bureau Veritas 1 3/3 +E Hopper Dredger Deep Sea AUT-MS.

Train ferry – A ship which transports railway carriages and passengers in a shuttle service between two particular terminals.

Train lift – A large installation used on board train ferries to enable train transport on two decks.

The ferry SKANE is equipped with a huge two-tier train lift. It has an overall platform length of 104m, 2x102m track length, a clear width of 7.2m, a clear height of 4.65m and a lifting height of 5.35m. This can accommodate two complete trains with a total weight of 816 tonnes. The lift platform is a partly open box construction, with two track levels connected by truss members carrying the overall load in the longitudinal direction.

Hoisting through a height of 5.35m is effected by eight hydraulic cylinders connected between the tanktop and the platform. The cylinders, located in recess in the longitudinal bulkheads and in the tanktop, are in pairs arranged to raise the lift at four points. Lift movements are controlled by level indicators at each point, signaling the hydraulic flow control system to ensure that the lift is operated equally at each corner.

The operating takes only three minutes from the start to finish and has been designed to help drastically limit turnaround time to 1h15. According to MER February 1999.

Tramp – A vessel operating without a fixed itinerary or schedule or charter contract.

Transformer – A device which generally consists of two windings on an iron core. An e.m.f. applied to the primary winding induces an e.m.f. in the secondary winding in the ratio of the number of windings on the primary and secondary.

Translifter – Hydraulically raised and lowered trailer which can slide through the center of a wheel-less **cassette** to load and discharge it from the vessel. See also **Rolux wheelless cassette system**.

Transmission efficiency – The ratio of delivered power to shaft power.

Transom stern – A square-ended stern used to provide additional hull volume and deck space at the aft.

Transport of bitumen products – Molten bitumen and related products are transported at high temperatures up to 250°C in independent tanks supported by means of special methods.

The bitumen/asphalt tanker RATHBOYNE has two independent cargo tank-blocks, each made up of four tanks with a total capacity of 5400m³. The cargo tanks exposed to temperatures of up to 250°C have been insulated with Rockwool. To accommodate the temperature differences and expansion/contraction associated with the transport of high-temperature liquids, the ship features a special system of tank support. This not only accommodates the high temperature differences but also alleviates energy loss through the plating. Tanks

can expand in three directions without any adverse effect on the ship structure. To achieve this, the tanks have been mounted on a total of 516 steel supports welded to the hull into which multiple superimposed layers of various rubbers, have been sealed. The main purpose of the combination of rubbers is to absorb the heat generated, so that the maximum 250°C cargo temperature is reduced to an acceptable 80°C. Tank heating is performed by means of a thermal oil system.

Transport of molten sulphur – Molten sulphur has to be carried at the temperature within the ranges of 120°C and 155°C – normally about 140°C – which places very heavy demands on the cargo equipment, also the heating, insulation of the tanks and pipework, as well as associated valves and pumps. Deepwell-type cargo pumps powered by deck-mounted electric motors are used. They are manufactured from mild steel but with bearings of special carbon material. The pumps have a heating jacket on the pipestack and shaft seal and cooling arrangements on the main bearings. Sulphur tanks are of the insulated, self-supporting type, resting on multiple supports in the hull. They are secured against rolling and pitching movements, but allowed to expand or contract with different cargo temperatures.

See also **Sulphur tanker SULPHUR ENTERPRISE**.

Transport of reefer containers – More and more refrigerated cargoes are carried in containers. On the other hand, high cube boxes are more and more popular. To be operationally efficient, new container carriers should be able to transport a large number of reefer boxes both on open deck as well as in holds optimized for high units. This creates new technical problems with respect to hull construction, ventilation, electrical power supply and control systems. Instead of a number of electrical plugs fitted on board, a suitable class notation shall be used to define reefer capacity of the vessel.

In order to accommodate reefer containers, the ship shall be provided with sufficient electrical power and a hold ventilation system able to deliver 4500 m³/h to each 40ft reefer box. A separate air duct shall serve each container stack. Air ducts shall have adjustable openings or elastic hoses to direct air to the lower part (1/3 height) of the container independent of the stowage pattern. Generally, each duct shall be served by its own fan, except for hold sides where two outermost air ducts can be served by one common fan. However the number of reefer 40ft containers served by one fan shall not exceed 16.

It is not easy to supply such a huge quantity of air, however much more difficult it is to enable a proper airflow through the hold to air outlet. Two solutions can be adopted:

1. Exhaust vents should be located between transverse hatch coamings on vessels with minimum freeboard.
2. Longitudinal gaps between hatch covers are natural air outlets on vessels with high freeboard, and in addition vents in longitudinal sides of hatch covers could be arranged.

Other problem is the requirement of Load Line Convention to close all openings in severe weather conditions. With longitudinal hatch coamings without openings, the outlet boxes located between transverse coamings are well protected against green water and most of them submerge at very large heel angle only. On the contrary, vent openings in longitudinal sides of hatch covers are not protected and in severe weather conditions at least 50% of them must be closed.

The best arrangement of air outlet is to combine both solutions in order to have at least 60%-70% of air outlets working even if venting openings at one side of hatch covers are closed.

Under sea-going conditions, the number and rating of service generators shall be sufficient to supply all sockets and the hold ventilation in addition to the ship essential services when any generator set is out of service. Ships designed for the carriage of more than 150 reefer containers are to be equipped with a remote reefer container monitoring system of the power cable transmission type.

Suitable accesses are to be provided to containers on deck and in holds for the maintenance and replacement of compressors and fans.

Transverse – Athwartships, at the right angle to the ship centreline.

Travelling block – The large heavy duty, multi-sheave lifting block which is used to support the weight of the drill string during drilling operations and to hoist a drill pipe and the casing into and out of the hole.

Trawler/seiner VEA

North Shipyard of Gdańsk in Poland completed the construction of a new class trawler/seiner VEA, which was delivered in January 2004.



The ship designed by Sawicon AS VEA is capable of trawling and purse seining and measures 60.40m overall with a beam of 12.60m, and a depth of 8.10m. The steel hull is topped with an aluminium superstructure. The layout has the trawl handled over the stern, with arrangements for the content to be brought forward and pumped out over the starboard side, with the separator and access to the fish tanks on the forward deck. The purse seine is handled and hauled over the starboard side.

The ship is laid out with nine refrigerated sea water (RSW) tanks forward with a total carrying capacity of 1000m³, chilled by a Skogland chiller system. Optimar supplied the vacuum pumps for discharging catches.

High pressure hydraulic deck equipment was supplied by Karmoy Winch, with a combined 62tonne purse/trawl winch, a 34tonne purse winch, a 62tonne trawl winch, and a Karmoy computer trawl system. Other equipment from Karmoy includes a 4tonne/12m knuckleboom crane and a 2.20tonne/9m fish pump crane. The netstacker has a lifting capacity of 5.50tonnes and a pull at the nethauler of 4tonnes.

Trawlers

For handling trawl gear VEA has a 24m³, 52tonne pull main net drum and smaller 18m³, 24tonne net drum. Karmoy also supplied the 16inch fish pump and the hydraulic skid-mounted power pack.

Length, oa: 60.40m, Length, bp: 54.40m, Breadth, mld: 12.60m, Depth to main deck: 8.10m, Maximum draught: 5.50m, Displacement 2,343t, Speed: 16 knots, Main engine: at 2880kW.

Trawlers – Vessels used for trawler fishing. They drag along a tunnel-shaped net (trawl) whose size and mesh vary according to ship size and fish species. Various types are in use: fresh-fish trawlers, freezer trawlers, factory trawlers, and super-trawlers. After catching, the fish must be processed and stored as quickly as possible. In case of large factory trawlers, the fish is processed by automatic systems inside the ship, i.e. killing and gutting, heading, washing and scaling, skinning, cutting and filleting, weighing, freezing and packing. Fresh fish is packed together with pieces of ice in deep freeze compartments at –30°C, or fully preserved in tins, whilst by-products such as fish-meal or oil are kept in special compartment and tanks. See also **Supertrawler HELEN MARY**.

Trawling – A fishing method with a gear towed through the water. The bottom trawling is used for demersal species. The mid-water trawls are used to capture **pelagic species** that move at various levels between the sea bed and the surface.

Multi-rig trawling, pair trawling – The fishing method with two small otter trawls towed from twin outrigger booms. The warps are led from the winch to the towing blocks at the boom ends and to the bridle attached to the doors of the net.

Trencher – A large underwater robot designed to inject water and/or air into subsoil to bury cables (or pipelines). It is a key equipment on board the **cable layer**.

TRIBON – An integrated design and information system created by Kockums Computer Systems to serve the shipbuilding and offshore industries. Tribon applications cover all aspects of design from the initial design to the production process, including advanced features for the assembly phase of ship production and materials control.

TriboPack technology – A package of design measures giving improved piston-running behaviour, lower wear rates, longer time between overhauls, and lower cylinder lubricant feed rates. TriboPack incorporated in Wärtsilä Sulzer RTA-series engines comprises:

Multi-level cylinder lubrication,

Liner with the appropriate material, with sufficient hard phase,

Careful machining and deep-honing of the liner over the full length of the running surface,

Insulating tubes in the cooling bores in the upper part of the liner,

Mid-stroke liner insulation,

Pre-profiled piston rings in all piston grooves,

Chromium-ceramic coating on top piston ring,

Running-in Coating piston rings in all lower piston grooves,

Anti-Pilishing Ring at the top of the cylinder liner,

Increased thickness of chromium layer in the piston ring grooves.

*For more information read **SULZER RT-flex60C Technology Review**.*

Tri-Cargo Carrier (TCC) – The new concept of combination carrier developed by Norwegian shipbroker, O-J Libaek. Unlike a conventional OBO, TCC has a centreline bulkhead in order to reduce the free surface effect and improve the overall structural strength. The TCC has large longitudinal hatch openings, served by single-piece hatch covers with double seals. Cargo pipes are located in the void spaces of the upper wing tanks.

STERN TRAWLER UTGAR

$L_{OA} = 79.63\text{m}$, $L_{BP} = 69.00\text{m}$,
 $B = 16.00\text{m}$, $D_{mid} = 9.50\text{m}$

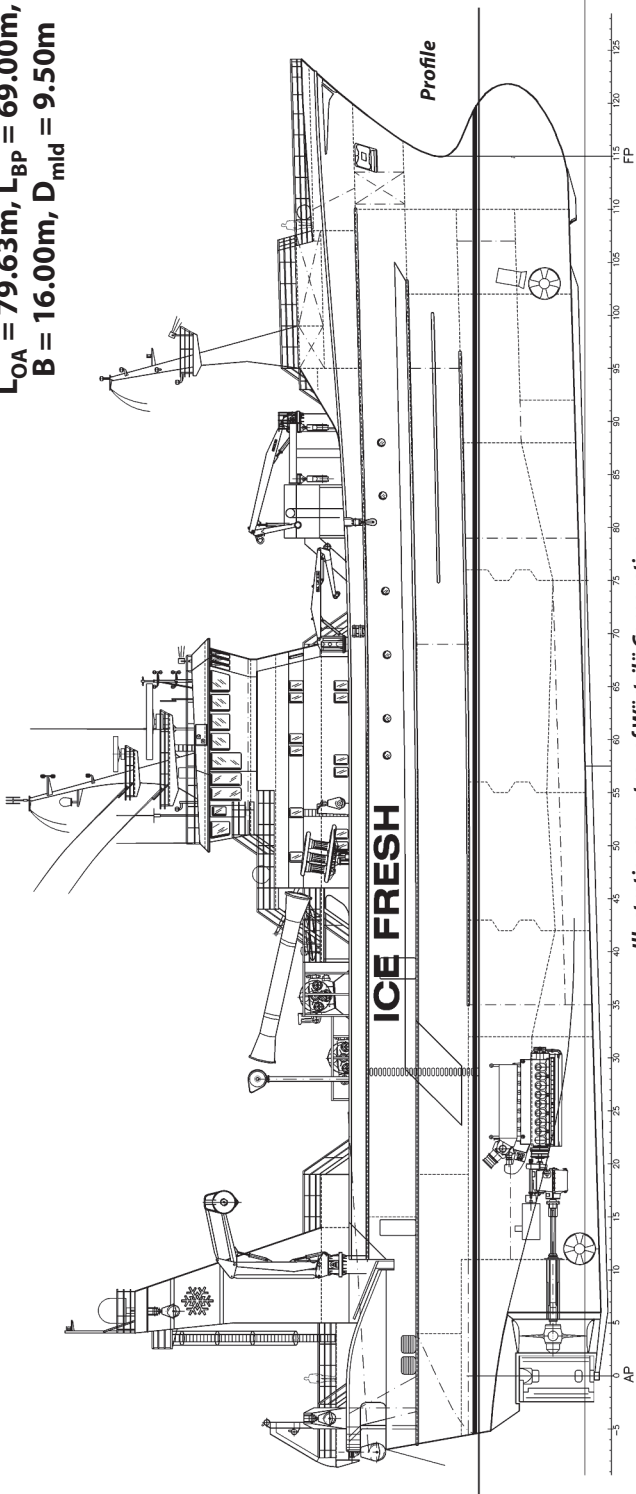

Illustrations courtesy of Wärtsilä Corporation

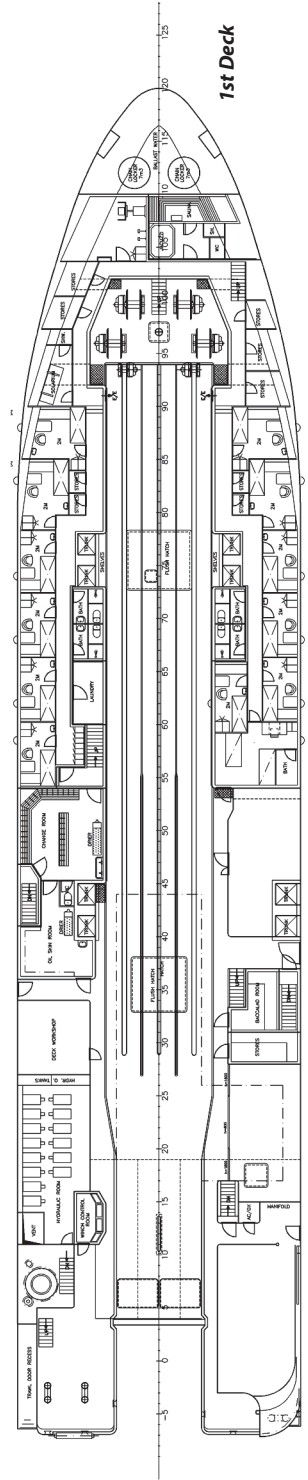

Trim – The difference of the drafts between forward and aft.

Trim and Stability Booklet – A stability manual, see **Stability Information**.

Trimaran ro-pax ferry **BENCHIJIGUA EXPRESS**

According to **Significant Ships** of 2005

Built by Austal Ships, Australia, the aluminium ro-pax ferry **BENCHIJIGUA EXPRESS** is the world first trimaran **ro-pax** ferry. The adverse effect of rough seas on passenger comfort when using earlier types of fast ferry was a major influence on the development of this revolutionary design which aims to provide a solution to the stability and layout issues typical of long slim monohulls. An advanced ride control system comprises a T-foil forward, two roll fins at the aft 2/3 position, and interceptors at the stern. Following **sea trials**, an additional **rudder** was fitted to enhance steering performance in extreme weather conditions.

BENCHIJIGUA EXPRESS is fitted with six of Liferaft Systems Australia's **MES**'s comprising four 14m twin-path slides and two 9m twin-path slides, all of which are fitted with a 100-person self-righting liferaft. An additional 10x100-person liferafts are installed and permanently linked to the MES, providing a total liferaft capacity for 1600 persons. The total weight of the complete system is 9320kg.

Two engine rooms are arranged aft of midship in the main hull. The aftermost of these spaces contains two MTU 20v 8000 M70 main engines, positioned either side of the centreline. Each develops 8200kW and is linked via a Renk reduction gear box to a steerable reversing **waterjet**. The third, central waterjet of 180 BII design is driven by two more MTU 20V 8000 main engines. All drive shafts on this ferry were manufactured by Vulkan from composite material. A complete analysis, both before and after the installation, was made by that company because of the long distances between bearings. The design is expected to accommodate misalignment very well.

Four MTU 12V 2000 M40 gensets, each rated at 540kW, are also installed in the foremost engine room with a fifth, emergency set, positioned on the observation deck. The machinery installation is completed by two 450kW Aquamaster UL601, retractable and azimuthing **thrusters** arranged in tandem under the bow of the central hull.

Vehicle access is over the stern at the main deck level from dedicated shore-based linkspans controlled from the ship. This deck, and a hoistable mezzanine deck, provide 450-lane metres for trucks and space for 123 cars. Alternatively 341 cars can be loaded. Passenger accommodation is situated on the upper deck within three lounge areas featuring individual seating arrangements, colour schemes and facilities.

Trimming (loading cargo) – The partial or total levelling of the cargo within the holds by means of loading spouts or chutes, portable machinery or manually.

Trimming (unloading cargo) – The shovelling or sweeping up of smaller quantities of the cargo in the holds by mechanical means (such as bulldozers) or other means to place them in a convenient position for discharge.

Trimming (ship) – Adding, removal or shifting of weight in a ship to achieve the required forward and aft draughts.

Tripping bracket – A flat bar or plate fitted to a deck girder, stiffener, beam, etc., to reinforce the free edge.

Tri/SWATH concept – A revolutionary concept of **well-intervention vessel** with a tri-hull configuration, being developed by QinetiQ and Norwegian company Oilfield Technology Group AS. A **SWATH** vessel normally consists of two parallel torpedo-like hulls attached to streamlined struts which pierce the water surface and support an above water platform.

The advantage of such design is that it is more stable, less prone to pitching and rolling and requires less power for propulsion than conventional designs. QinetiQ's unique approach to SWATH design is to develop vessels with a trip hull, which provides even greater stability and will allow oil companies to conduct complex works in very stormy waters.

The Tri/SWATH vessel should also allow the well intervention work to be performed at one fifth of the cost of traditional anchored, semi-submersible vessel, or less than half of the cost of dynamically-positioned one.

Trolling – The fishing method used for the capture of high-value **pelagic** species, such as salmon and tuna. The troller pulls through the water a number of lines equipped with lures on short leaders. The vessel is frequently equipped with two or more outriggers to provide spreading of lines for bigger coverage.

Trunk – A vertical or inclined space or passage formed by bulkheads or casings, extending one or more deck heights, around openings in the decks, through which access can be obtained and cargo, stores, etc. handled, or ventilation provided without disturbing or interfering with the contents or arrangements of the adjoining spaces.

Trunk piston engine – An internal combustion engine in which the connecting rod is directly connected to the piston by a gudgeon pin (also called piston pin).

TTS Folding Frame – Patented bow ramp/door arrangement developed by TTS Ships Equipment. A collision bulkhead door is separated from the steel frame positioned forward. In the fully outfolded position, the frame, together with the outer section, forms the load carrying structure. The door is opened and put down as a flap on the frame.

TTS winch bollard (TTS WB) – Novel mooring equipment developed by TTS Marine. TTS WB can hold the mooring rope like a normal bollard but can also tighten and release it in a controlled way. The winch bollard mooring system is simpler and safer than conventional mooring systems. Less space is required and instead of two people generally required to handle the mooring operation, when fixing rope at a bollard, it can be operated by one person.

Tubular – A generic term for a family of hollow section products of various cross-section configuration. The term **pipe** denotes cylindrical products to differentiate them from square and rectangular hollow section products. However, a **tube** or tubing can also be cylindrical.

Tubes – Tubes are generally small-diameter thin-wall pipes. Tubes are to meet the same general requirements as pipes.

Tugs – Small vessels designed to tow or push large ships or barges. Tugs have powerful **diesel engines** and are essential to docks and ports to manoeuvre large ships into their berths. Pusher tugs are also used to push trains of barges on the rivers and inland waterways. Oceangoing salvage tugs provide assistance to ships in distress and are engaged in such work as towing drilling rigs and oil production platforms.

The **bollard pull** is the leading requirement for tugs. There are two main tug types: those with their propulsion aft and towing point near amidships, i.e. conventional ones, or those with their towing point aft and propulsion forward of amidships, i.e. tractor tugs. Tugs with azimuthing propulsion, either Z-drive or cycloidal, have effectively displaced single or twin screw tugs.

Azimuthing Stern Drive (ASD) tug, stern drive azimuth tug – The tug with two azimuth thrusters under the stern. ASD tugs perform the majority of towing operations over the bow, from a winch mounted on the fore deck.

Carousel tug – New type of tug provided with the carousel system, which enables the towing point to be changed according to the direction of the tow. This greatly reduces the capsizing moment. It is even claimed that it is not possible to capsize a carousel tug. The system uses a circular ring attached around the base of the superstructure on the tug. This consists of two parts: the fixed inner ring and the rotating outer ring. A simple towing hook is mounted on the outer ring as the attachment point for the towline.

Novatug's Carrousel system increases the effectiveness and lowers the cost of harbour and escort tugs. It works by placing a ring around the tug's superstructure that rotates freely, with the towing wire connected to the ring by a hook or winch, allowing the towing wire to rotate freely from the tug's hull. This leaves no need for rotation of the tug's propulsion by means of expensive, complex and high-maintenance thrusters.

The Carrousel system enables the towing wire to rotate 360 degrees around the tug. The prototype of the Carrousel tug, 'Multratug 12', has executed numerous harbour towage assistances during a test period. The results show that breaking and steering powers can be multiplied by a factor of five, whilst safety remains guaranteed. At the same time operating costs (fuel, maintenance, surveys and damages) are substantially decreased.



Escort tug W TUG 80 designed by Wärtsilä bollard pull 80 tonnes, speed abt. 14 knots, L_{OA} 35.40m

Escort tug – A novel fast type tug designed to assist tankers in areas of high environmental risk. Escort tugs run with tankers at speeds of up to 14 knots to provide an emergency steering and breaking force capability.

Forward azimuth tractor – The tug with two azimuth thrusters under the forebody.

Rotor tug – A new patented concept in the tug design with a unique propulsion system utilising three main engines, each driving a fully azimuthing propulsion unit. Two propulsion units are located forward off the centreline, in the normal tractor configuration, with the third unit aft off the centreline replacing traditional aft **skeg**. The tug has the ability to turn rapidly in its own length, and apply almost all of its bollard pull in any direction. The lack of a substantial skeg reduces resistance to turning and cuts down the influence of a ship propeller wash when working in close proximity to large vessels underway. Astilleros Balenciaga delivered the first pair of Rotor tugs – RT Innovation and RT Pioneer in 1999.

Salvage tug – A tug having specific equipment for salvage.

Standby tug – A vessel which is stationed at a specific location with the primary purpose of preventing a ship in trouble becoming a major casualty with the risk of pollution. Alternatively, where an accident has already happened to provide salvage and clean up facilities as quickly as possible to prevent the situation becoming worse.

Tractor tug, originally Water Tractor – The unique tug concept developed by Voith-Schneider for the use with **cycloidal propellers**. A classic tractor tug has some characteristic features, such as:

1. Propulsion and steering system freely arranged underneath the hull at one end of the vessel.
2. A keel plate underneath the freely-arranged propulsion and steering device protecting the units against grounding and obstacles in all directions.
3. Rudder-shaped fin underneath the hull, opposite to the propulsion and steering devices.
4. The towing gear above the fin.

Tumble home – The fall-in of the ship sides amidships.

Tunnel – A watertight access passage surrounding the propeller shaft fitted on a ship where the machinery space is positioned towards midships.

Turbine – A turbine is any motor in which a shaft is steadily rotated by the impact of a current of steam, air, water or other fluid directed from jets or nozzles onto the blades of a wheel. A turbine generally consists of a series of curved blades or vanes on a central spindle arranged to rotate. The whole of it is enclosed by a casing fitted with passageways that let the fluid in and out as necessary.

Turbines are primarily classified according to the fluid employed in: water or hydraulic turbines, **steam turbines**, **gas turbines**, mercury-vapour turbines and others. According to the principal direction of fluid flow, they are classified into parallel-flow turbines or axial-flow turbines, radial-flow turbines (including the outward and inward-flow types), mixed-flow turbines, and so forth.

If we compare turbines with other prime movers we can see that they require less floor space, lighter foundation, less attention, lower consumption of oil and maintenance cost and excellent regulation. They have extreme overload capacity and great reliability because of their simplicity of construction.

Turbidity – Turbidity is a measure of water clarity how much the material suspended in water decreases the passage of light through the water. Suspended materials include soil particles (clay, silt, and sand), algae, plankton, microbes, and other substances. These

Turbocharger

materials are typically in the size range of 0.004mm (clay) to 1.0mm (sand). Turbidity can affect the color of the water.

Turbocharger – A turbine designed to charge the diesel engine cylinders with air at a higher pressure utilizing energy from exhaust gas and hence increase the density of charge air above atmospheric pressure. The term turbocharging refers also to superchargers, turboblowers, scavenge blowers which are mechanically or electrically driven. See also **Exhaust gas turbocharger**.

Turbulent flow – Fluid flow where the particle motion is rapidly changing both in direction and magnitude at any point. It occurs at high Reynolds numbers.

Turning circle test – see **manoeuvring trials**.

Turning gear – A reversible electric motor which, through a system of gears, can be used to turn slowly a large **diesel engine** or **steam turbine** and gearbox assembly. It enables precise positioning for overhaul or examination. The engaging and disengaging of the turning gear is accomplished by the lever.

Turret – A device providing a connection point between an offshore unit and the combined riser- and mooring- systems, allowing the unit to rotate around the turret (weather vane) without twisting the risers and mooring lines.

Turret mooring – The **single point mooring** system. A turret mooring system consists of a number of mooring legs attached to a **turret** that is designed to act as a part of the vessel, allowing only for angular relative movement of the vessel to the turret, so that the vessel may weathervane. The turret may be mounted internally within the vessel or externally from the vessel **bow** or **stern**.

For an internal turret system, the turret is supported in the vessel by a system of bearings. Typically, a roller bearing is located near the vessel deck level. A radial sliding bearing is located near the keel. For an external turret mooring system, the vessel is extended to attach the turret mooring system at the end of the vessel.

Turret mooring system of FPSO – A mooring turret is installed at the centre of the ship, where all anchoring lines terminate and around which the ship is free to make rotations, enabling it to select a favourable heading for the environment. The mooring forces applied to the vessel are introduced and accommodated by the turret components contained within the hull.

*The turret mooring system of the **FPDSO** consists of an array of anchor legs, connected at their lower end to an anchor point and at their upper end to the turret. The turret cylinder accommodates the entry points for the anchor legs and the risers at its lower end. At its upper end there is an anchor leg tensioning system with chain lockers and the riser support structures. In the turret, the chains are accommodated in tubes with flared trumpet exits at their lower end. The turret at its upper deck supports up to 16 individual chain lockers which accommodate the additional lengths of chain that are paid-out or pulled-in when the vessel is relocated above each drilling template.*

Turret transfer system of FPSO – Turret transfer system is designed to manage the production and service lines which pass through the central **moonpool** of the hull as it pivots around its central mooring point. Depending on wind and sea currents, FPSO is able to turn through 270deg. The turret forms a non-rotating platform for the mooring system.

At the heart of the system there is a specially developed, side-running drag chain which is capable of managing all the lines: for water injection, well testing and service, gas injection, in addition to those for electro-hydraulic supply under the sea, and air supply. The chain is mounted on the top of the turret and allows for continuous production as the vessel revolves around the turret. It also controls electrical power, signal and control cables.

Turret transfer system of the FPSO SCHIEHALION

In service, SCHIEHALION will operate above the field of four main drilling centres, secured by 14 anchor legs made up of 160-mm diameter studless chain and wire rope, fixed to anchor piles arranged within a 1650-m radius. Rigid steel flowlines and flexible risers connect production and water injection wells at each centre to the FPSO. The moorings and risers are attached to a 14m diameter top-mounted internal turret inserted through the hull at the fore end. This allows “weathervane” movement around the anchored position and can accommodate up to 24 risers, as well as tensioning mooring winches, manifold and swivel arrangement.

Tween decks – The upper cargo stowage compartments or the space between any two adjacent decks.

Twin-skeg hullform – Twin-skeg afterbody can be highly beneficial on ships with full forms, especially when low draught or high beam-to-draught ratio is required. A twin-skeg design has been adopted on new tankers with redundant propulsion. See also **skeg**.

Twistlock – A mechanical locking device at the corner of a container. Conventional twistlocks are locked and unlocked manually with operating rods. Rotating the movable part around a vertical axis locks the device and a container to a twistlock foundation on a hatch cover or another container. Reversing the motion effects unlocking.

Semi-automatic twistlocks are locked automatically and unlocked manually by the operating rods. Fully-automatic locks are placed in the lower corners of the container at the pier. They lock automatically after the container is placed on the top, and unlock automatically when the container is lifted.

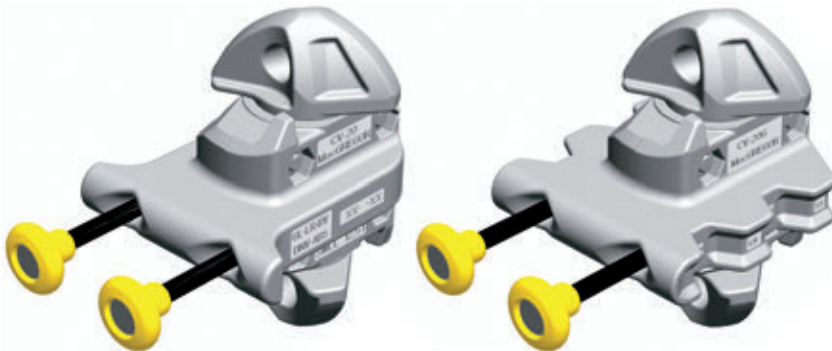

Illustration courtesy of MacGREGOR

SAT CV-20 is fully symmetrical semi-automatic twistlock developed by MacGREGOR. When containers are loaded at a fast rate, incorrect insertion of twistlock will cause major danger and delays in the cargo handling process. The CV-20 twistlock can be inserted into the container corner castings either way-up – incorrect insertion is not possible.

Two pack paints, also two-components paints – Paints which are supplied in two separate containers and which have to be mixed before use.

U

Ullage – The distance from the top of the hatch, or from the top of the inspection cover in the hatch, down to the surface of oil in the cargo tanks of oil tankers. A short steel graduated rod attached to the end of a measuring tape is dropped down until the rod touches or goes part way into the surface of the oil. The corresponding capacity tables are known as ullage tables.

ULEPSI tank support system – Manufactured by Beele Engineering of the Netherlands, the support system suitable for tanks with cargo temperatures up to 250°C. Such tanks cannot be directly secured to the ship's hull. The layered and compression-resistant construction ensures that the temperature is gradually reduced, in order to relieve strains caused by large temperature differences between the tank wall and seawater.

Ultra large crude carrier HELLESPONT ALHAMBRA

During the golden boom years on the tanker market, from 1967 until the oil crisis of 1973, orders for about 80 VLCCs (200,000-320,000 dwt) and 40 ULCCs (over 320,000 dwt) were placed. This boom was followed by the total collapse of the newbuilding market for these tankers until the middle of the 1980s. Since then, over 400 VLCC have been ordered but it took about 20 years before the next ULCC contract was signed, i.e. Hellepont. After the absence of nearly 30 years from the newbuilding scene, the ultra large crude carrier (ULCC) made a comeback with the delivery of the 441,893 dwt HELLESPONT ALHAMBRA to its owner, the Greek tanker company Hellepont Shipping.



Picture courtesy of Wärtsilä Corporation

Nicknamed the “white elephant” because of its appearance of a wide-bodied white hull, the HELLESPONT ALHAMBRA is the first ship in a four-ship contract placed with the South Korean shipbuilder Daewoo Shipbuilding & Machine Engineering Co. The ship is the largest double hull tanker ever built and is reported to have cost about \$90 million. The design for these high specification of 3.2 million barrel vessels was subject to extensive model tests

of the hydrodynamic design by the Swedish research organisation SSPA, an organisation involved in testing 30% of the ULCCs previously built. This included the 555,000 dwt BATILUS delivered in 1976.

The Hellepont quartet is being built for the traditional ULCC route from the Arabian Gulf to the US and Northern European markets. In this trade it makes economic sense to transport the maximum amount of oil as quickly as possible thereby getting paid more and earlier than the smaller and slower VLCCs. This benefit could be worth \$70-80,000 per voyage, which in theory, more than pays for the extra power. Achieving this without compromising strength and safety was a priority in designing these newbuilds which are 50% larger than any double-hull ship ever built.

The series is being built to LR and ABS class and elevates standards for large tanker strength and speed with a number of unusual features that will make the newbuildings more reliable and efficient while enhancing safety and environmental factors. Their scantlings have been designed to incorporate approximately 15% more steel than the minimum class requirements to give a potential working life of about 40 years without the need for major repairs or steel replacement. Some 35% of this extra steel is of the high-tensile variety for added strength, mainly in bulkheads, and the total steel content will amount to 66,500 light weight compared to 59,000 for one built to the minimum class standard.

The high specification includes a powerful Wärtsilä 9RTA84T-D engine delivering 36,900kW at 76 rev/m, driving a 10.5m diameter fixed pitch propeller weighing approximately 90t via a 1m diameter propeller shaft. This results in a relatively fast service speed of 16.5 knots at design draught and a ballast speed of 17.5 knots. The nine-cylinder engine was chosen because in tests it offered considerably less vibration than other engines on the market. The relatively fast service speed should also provide significant cost savings for the cargo owner. The vessel has three Wartsila 9L20 auxiliary engines, each of 1530kW output at 900 rpm.

Much attention has also been devoted to ballast tank protection, with all ballast tanks, except for the aft peak tank, to be inerted with double-scrubbed gas with a maximum of 5% oxygen (O₂) and 1ppm sulphur dioxide (SO₂). This double **scrubber** system increases the condensing of H₂O vapour and produces a very clean gas which, in the long-term, should minimise the probability that the ship will have to undergo an estimated \$12 million recoating operation by reducing the risk of oxidation in the double-hull ballast spaces. The vessel will also feature the Vent 2D system developed by Hellepont to model air and gas flows in double hull spaces. This software system constantly records pressure and levels of O₂ and SO₂ to reduce fire and explosion risk.

A most unusual feature is a **bridge** whose wings do not extend to the ship sides. Instead of this the ship is equipped with closed-circuit colour TV cameras. Such solution eliminates work on the wings under difficult conditions. Potential vibration from the **bridge wing** structures will also be eliminated.

Another interesting feature of these ships is that all side shell above the deep draught water line, excluding the funnel, is painted white. By using a reflective colour, the temperature of the steel decks can be reduced and keep the cargo cooler. It will help to lower the amount of hydrocarbon emission resulting in less cargo loss. At the same time it helps to protect internal coatings from the heat of the sun thus minimising degradation of the epoxy ballast tank coatings due to thermal cycling.

Ultra long stroke engine

These extra design features have cost the company an estimated \$10million more than the basic version of a similarly sized ship. The company argues that the cost is easily recuperated in the predicted extra operational life of the vessel, savings in inerting and maintenance together with increased revenue and profits due to the higher transit speed.

Length, oa:380.00m, Length, bp: 366.00m, Beam: 68.00m, Depth, moulded: 34.00m, Draught scantling: 24.50m, Deadweight scantling: 442,470dwt, Lightweight: 67,000t, Cargo capacity: 513,684m³, Main engine: Wärtsilä Sulzer 9RTA84T-D, Output, MCR at 76 rev/min: 36,900kW, Speed, loaded 95%MCR, 15% sea margin:16.5 knots, Speed in ballast:17.9 knots, Main engine fuel consumption:141t/day.

Ultra long stroke engine – A slow-speed, two-stroke engine which uses a large stroke to bore ratio to utilize the improved thermodynamic efficiency resulting from the uniflow scavenging. It also uses a lower shaft speed to improve the propeller efficiency.

Ultra low sulphur diesel – Diesel fuel having sulfur content of 0.0015 percent (15 ppm) of sulfur or less, (EPA).

Ultrasonic testing – The use of high frequency sound waves to test a material. They are reflected from the far side and can be displayed on a cathode ray oscilloscope. A defect will be shown and its size and location may be found.

Further reading: ABS Guide for “Nondestructive Inspection of Hull Welds” (2002), can be downloaded from www.eagle.org

Umbilical – The connecting hose to a tethered submersible unit and from this unit to the divers. It may contain life support, surveillance, communication, remote control and power supply cables, (ABS).

The most common form of an umbilical contains electric cables for transmitting power and signals and high, medium- or low-pressure tubes for carrying hydraulic liquids and chemicals. In the manufacture, one element is placed at the core of the umbilical – it may be a power cable, a tube, or a bundle of tubes. The other elements are then arranged around the core, if necessary in more than one layer. Fillers are placed between the elements to provide a stable construction, and a plastic sheath may be applied as an outer layer.

Undercut – A groove melted into the base metal adjacent to the weld toe or weld root and left unfilled by weld metal.

Underwater complex – A complex comprising of any combination of habitats with transfer chambers, and may include a tethered or untethered submersible unit and its **launch and recovery system**, (ABS).

Underwater container – A permanently unmanned submersible vessel containing equipment that is to be protected from water. It may be anchored to the ocean floor, (ABS).

Underwater system – A system comprising of one or more units with all their support components necessary to conduct a specified manned underwater operation such as a **diving system** and an **underwater complex**, (ABS).

Underwater vehicles – Self-propelled crafts intended for underwater operations that may or may not be independent of surface support, (ABS).

Remotely operated vehicles (ROVs) – Cable-controlled underwater vehicles used for underwater inspection, repair and maintenance. Long before the drilling rig support, ROVs were used to dig trenches and cover transocean communication cables.

Autonomous underwater vehicles (AUVs) – Novel subsea fully autonomous vehicles built for deepwater commercial survey works such as site surveys and pipeline route studies.

The C&C Technologies HUGIN 3000 is 5.2m long, 0.96m diameter with a depth rating of 3000m. It is powered by a unique aluminium oxygen fuel cell developed to give the vehicle an endurance of 40 hours. The normal speed is four knots. Survey systems include a Simrad EM2000 multibeam and bathymetry system, EdgeTech chirp sidescan sonar, EdgeTech chirp 2-16kHz subbottom profiler, Seabird CTD and a magnetometer.

Underwriter – A person participating in an underwriting syndicate or group that provides insurance cover for a vessel.

Underwriting – The manner in which ships and other vehicles of transport are insured. Underwriting involves the sharing of risk by several individuals or even groups of individuals (possibly in more than one organizations).

UNIC davit – A new space-saving **lifeboat** davit system for cruise vessels, developed by Schat-Harding.

UNIC engine automation system - Modular, embedded control system for control and monitoring of diesel and gas engines developed by Wärtsilä. The system facilitates fundamental engine safety functions, engine monitoring and control of fuel injection and ignition functionalities. The system also includes start/stop logics and speed/load control.

UNILOCK – The MacGregor universal **twistlock** that can be used as a semi-automatic twistlock, an automatic fixing cone or bottom automatic fixing cone. As stevedores do not have to ensure the correct combination of twistlocks and midlocks, the UNILOCK eliminates the decision process, thus avoiding potential errors.

Unsymmetrical flooding – The entry of water into a compartment on one side of the ship which will cause heeling, in addition to the effects of flooding.

Upper flammable limit (UFL), upper explosive limit – The concentration of a hydrocarbon gas in air above which there is insufficient amount of oxygen to support and propagate combustion. Sometimes referred to as upper explosive limit (UEL).

Uptake – A metal casing or large-bore piping which carries exhaust gases up through the funnel to the atmosphere.

Urea – Urea, $(\text{NH}_2)_2\text{CO}$, is a common chemical commodity used in a wide range of products. For NO_x reduction urea is normally delivered as a ready mixed solution with 40% of urea and 60% of de-ionised water, and specific weight about 1112 kg/m³ at 20°C. Steel tanks should be internally coated with epoxy or similar material and pipes and fittings should be made of stainless steel or plastic (Urea is corrosive on Copper and its alloys). The consumption of urea solution is generally within 5-8% (wt) of the fuel consumption depending on the desired NO_x reduction versus the base line emission.

Vacuum cleaners – Industrial vacuum cleaners can be used to remove shipyard debris (dust, weld slag and welding rod ends).

Vacuum toilets – A new type of toilets operating on the vacuum principle. Usually, the vacuum is created by an ejector. The vacuum toilets use a freshwater fed directly from the main without the need for a header tank. With only about 1.5 litres of water per flush, the vacuum system uses smaller diameter outlet pipework.

Useful website: www.evacgroup.com

Valve – A device provided in a **pipng system** to regulate or stop the liquid flow. Although many different types of valves are used to control the flow of fluids, the basic valve types can be divided into two general groups: **stop valves** and **check valves**. Stop valves are used to shut off or, in some cases, partially shut off the flow of fluid. They are controlled by the movement of the valve stem. Check valves are used to allow fluid flow in a system in only one direction. They are operated by the flow of fluid in the piping.

Ball valve – Ball valves are stop valves that use a ball to stop or start the flow of fluid. The ball performs the same function as the disc in the **globe valve**. When the valve handle is operated to open the valve, the ball rotates to a point where the hole through the ball is in line with the valve body inlet and outlet. When the valve is shut, which requires only a 90-degree rotation of the handwheel for most valves, the ball is rotated so the hole is perpendicular to the flow openings of the valve body and thus the flow is stopped.



Photos: J. Babicz

Butterfly valve – A rotary stem valve with a centrally-hinged disc of the same diameter as the pipeline. The valve opens into the pipeline and therefore takes up little space, permits large flow rates and gives minimum pressure drop.

Gate valve – Gate valves are used when a straight-line flow of fluid and minimum restriction is desired. Gate valves are named so because the part that either stops or allows flow through the valve acts somewhat like the opening or closing of a gate. The gate is usually wedge-shaped. When the valve is wide open, the gate is fully drawn up into the valve, leaving an opening for flow through the valve of the same size as the pipe in which the valve is installed. Therefore, there is little pressure drop or flow restriction through the valve. Gate valves are not suitable for throttling purposes since the control of flow would be difficult due to the valve design and since the flow of fluid slapping against a partially-open gate can cause extensive damage to the valve.

Quick closing valve – Oil tank suction valves are arranged for rapid closing from a remote point. The collapsing of the “bridge” results in the valve closing quickly under the combined effects of gravity and an internal spring.

Pressure-reducing valves – Pressure-reducing valves are automatic valves that provide a steady pressure into a system that is at a lower pressure than the supply system. Reducing valves of one type or another are found, for example, in firemain, seawater, and other systems. A reducing valve can normally be set for any desired downstream pressure within the design limits of the valve. Once the valve is set, the reduced pressure is maintained regardless of changes.

Relief valve – Relief valves are automatic valves used on system lines and equipment to prevent overpressurization. Most relief valves simply lift (open) at a preset pressure and reset (shut) when the pressure drops slightly below the lifting pressure.

Remote-operated valves – Remote-operating gear is installed to provide a means of operating certain valves from distant stations. Remote-operating gear may be mechanical, hydraulic, pneumatic, or electric. Some remote-operating gear for valves is used in the normal operation of valves. For example, the main drain system manual valves are opened and closed by a reach rod or a series of reach rods and gears. Reach rods may be used to operate engine-room valves in locations where the valves are difficult to reach from the operating stations.

Safety valve – A valve that opens automatically in the event of excess pressure in a vessel, like a boiler steam drum. A safety valve is normally fitted with easing gear. Every boiler should have two safety valves mounted directly on the shell or steam drum.

Valve cage – A cylinder fitted with ports in which a valve plug moves. The port openings are shaped to produce various flow characteristics for different valves, e.g. linear or equal-percentage.

Valve characteristics – The relationship between the valve lift and flow. It is of particular importance for the control valves. The common characteristics are quick-opening, linear and equal percentage.

Valve chests – Valve chests are a series of valves all built into a single block or a manifold. Various arrangements of suction and discharge connections are possible in this assembly.

Valve disc – A movable cover which provides a variable restriction to fluid flow. A control valve may have two discs or valve plugs which are specially shaped to create the **valve characteristics**.

Valve manifold – Sometimes suction must be taken from one of many sources and discharged to other units of either the same or another group. A valve manifold is used for this type of operation.

Vapour emission control system – An arrangement of piping and other equipment used to control vapour emission during tanker operations, including ship and shore vapour collection systems, monitoring and control devices and vapour processing arrangements.

Vapour lines – The vent pipes from cargo oil tanks. They are led to pressure/vacuum valves which are usually mounted on standpipes some distance above the deck.

Vapour lock system – Equipment fitted to a tank to enable the measuring and sampling of cargoes without release of vapour/**inert gas** pressure.

Vapour pressure – The equilibrium pressure of the saturated vapour above a liquid expressed in bars, absolute at a specified temperature, (**IBC Code**).

Variable Injection Timing (VIT)

Variable Injection Timing (VIT) – VIT has been a traditional feature of Wärtsilä (Sulzer) slow-speed engines allowing to adapt an optimum injection timing over an engine load to various fuel properties having a poor combustion behaviour. Primarily mechanical arrangement, used to keep cylinder pressure high for the upper load range, was changed in the common-rail **Wärtsilä RT-flex engines** to fully electronically-controlled feature giving longer lifetime and improved part-load fuel consumption.

Variable Inlet Valve Closing (VIC) – The optional system for Wärtsilä 46F engine. VIC offers the flexibility to apply early inlet valve closure at high load for lowest NOx levels, while good part-load performance is ensured by completely removing the advanced inlet valve closure at part-load.

Ventilation – Ventilation is the circulation and refreshing of the air in a space without necessarily a change of temperature. This is generally accomplished by a combination of supply fans, exhaust fans, and ductwork.

Natural ventilation – Natural ventilation occurs when changes in temperature or air density cause circulation in the space.

Mechanical ventilation – Forced ventilation. Fans are used for a positive movement of large quantities of air.



Ventilator – Any grid, vent pipe or opening through which air can enter or leave a space. Vent pipes on the weatherdeck can be a source of water ingress to lower deck areas. Strong built-in vent trunks are safer solutions.

Ventilator coaming heights – According to the International Convention on Load Lines, 1966, ventilators in position 1 shall have coamings of a height of at least 900 millimetres above the deck; in position 2 the coamings shall be of a height at least 760 millimetres above the deck. In both cases, ventilators shall be provided with efficient weathertight closing appliances. Ventilators in position 1 the coamings of which extend to more than 4.5 metres above the deck, and in position 2, the coamings of which extend to more than 2.3 metres above the deck, need not be fitted with closing arrangements.

Note: Ventilator openings for the machinery space shall be fitted in a position where weathertight closing appliances are not required.

Ventilator head – A cover arrangement which is fitted over a **ventilator** to prevent the entry of rain, or sea water. It may also be used as a means of closure.

Venting system of chemical tankers – The cargo tanks of chemical tankers are required to be provided with venting systems which are independent of air pipes and vents serving other parts of the ship. The functions of venting are to relieve pressure and prevent the formation of a vacuum where pressure differential could impair the structure of the tank.

Controlled tank venting system – A system fitted with pressure/vacuum relief valves. Controlled venting systems are required to be fitted to all tanks carrying cargoes which emit harmful or flammable vapours.

Open tank venting system – A system which offers no restriction, except for friction losses and flame screens if fitted, to free flow of liquid vapour to or from the tank served during normal liquid transfer or ballasting operation. Open venting is specified for cargoes which pose little or no flammable or toxic hazard.

Vertical welding position – The welding position in which the weld axis, at the point of welding, is approximately vertical, and the weld face lies in an approximately vertical plane.

Very high frequency (VHF) – The direct method of voice communication. It is limited in range with normal equipment to under 100 miles, though this distance will vary according to weather and atmospheric conditions.

Very large crude carrier (VLCC) – Tankers in the 250,000 to 300,000 tonnes deadweight range were first introduced in the mid-1960s.

Ship	UBUD	LIMBURG	RAPHAEL	HARAD	CAPRICORN
Delivery	2000	2000	2000	2001	2003
Shipyard	IHI Japan	Daewoo Korea	Hyundai Korea	Samsung Korea	Hyundai Korea
Length, oa	330.00 m	332.00 m	335.00 m	333.30 m	333.00 m
Length, bp	316.60 m	320.00 m	320.00 m	318.00 m	319.00 m
Breadth, moulded	60.00 m	58.00 m	58.00 m	58.00 m	60.00 m
Depth, moulded	28.90 m	31.00 m	31.00 m	31.25 m	30.50 m
Draught design	19.10 m	20.80 m		21.40 m	21.50 m
Draught scantling	20.41 m	22.00 m	22.70 m	22.50 m	22.50 m
Deadweight design		278,95 dwt		284,000 dwt	299,000wt
Deadweight scantling	279,999 dwt	299,364 dwt	309,600 dwt	303,100 dwt	317,000 dwt
Gross tonnage	149,383	157,833	157,833		164,000
Displacement	341,097 t	341,097 t		350,900 t	
Lightweight	41,732 t	41,732 t		47,800 t	
Cargo capacity	328,458 m ³	347,593 m ³	349,600 m ³	350,100 m ³	352,000 m ³
Width of side structure	3.48 m	3.52 m	3.52 m	3.38 m	3.50 m
Bottom height	2.98 m	3.00 m	3.00 m	3.00 m	3.00 m
ME output (MCR)	29,400 kW	23,520 kW	23,520 kW	33,600 kW	23,520 kW
Service speed	16.10 knots	15.80 knots	15.20 knots	16.40 knots	14.60 knots

Very large crude carrier FRONT CENTURY

Propeller diameter	9520 mm	9800 mm	9700 mm	10,200 mm	10,000 mm
ME fuel consumption	89.70 t/day		92.47 t/day	124.70 t/day	90.20 t/day

Very large crude carrier FRONT CENTURY

According to **The Motor Ship** December 1998

The 311,000dwt double-hull VLCC FRONT CENTURY was built by Hyundai Heavy Industries, Korea, in 1998. The ship has a total of 15 cargo oil tanks: five centre oil tanks and five pairs of side cargo tanks, with a combined capacity of 336,032m³. In addition, there are two slop tanks, which were completely coated in coal tar epoxy. Cargo space is protected by water ballast tanks, consisting of double bottoms and double sides.

The cargo pumping system allows for a maximum unloading rate 15,000 m³/hr, via three main cargo **pumps**. Furthermore, a maximum loading rate of approximately 20,500m³ can be achieved through the manifolds.

Three grades of oil can be handled simultaneously. Three 5000m³/hr vertical centrifugal pumps, which are driven by the steam turbine, one 450m³/hr steam-driven cargo oil stripping pump and two 700m³/hr cargo oil stripping eductors make up the oil cargo handling package on board.

For tank cleaning and **COW** system operations, all the cargo tanks and slop tanks are fitted with programmable **washing machines**. All the cargo and slop tanks are fitted with an accurate radar type level **gauging system**.

Length, oa: 335m, Length, bp: 320m, Breadth, mld: 58m, Draft design/scantling: 20.95/22.7m, Gross tonnage: 157,976t, Deadweight design/scantling: 281,600/311,100t, Output (MCR); 25,485kW x 79 rev/min, Service speed (15% sea margin); 15.7 knots, Crew: 32.

Vessel constrained by her draught – A power-driven vessel which, because of her draught in relation to the available depth and width of the navigable water, is severely restricted in her ability to deviate from the course she is following, (COLREG).

Vessel engaged in fishing – The term “vessel engaged in fishing” means any vessel fishing with nets, lines, trawls or other fishing apparatus which restrict manoeuvrability, but does not include a vessel fishing with trolling lines or other fishing apparatus which do not restrict manoeuvrability, (COLREG).

Vessel not under command – The term “vessel not under command” means a vessel which through some exceptional circumstance is unable to manoeuvre and is therefore unable to keep out of the way of another vessel, (COLREG).

Vessel restricted in her ability to manoeuvre – A vessel which due to the nature of her work is restricted in her ability to manoeuvre and is therefore unable to keep out of the way of another vessel. The term includes vessels engaged in laying, servicing or picking up navigation marks, submarine cables or pipelines, vessels engaged in dredging, surveying or underwater operations, vessels engaged in towing operations, etc.

VIBRATION

Excessive vibration of ship structures and equipment can be a serious problem and lead to failure of the propulsion system, structural failures of the primary structure and damage to shipboard equipment. Even if the vibration level is not high enough to result in major

damages, it can lead to crew discomfort and fatigue and increase the frequency of maintenance works for ship systems.

Due to the potential serious nature of the vibration problem, limit values that must not be exceeded during operation of the ship are defined in **Specifications**. The shipyard thus bears the responsibility for ensuring that these limits are not exceeded or – if they are – for taking action with the aim of reducing the vibration level to acceptable value. However, solving vibration problem on a completed ship can be very costly and time-consuming.

Therefore, it is recommended to take all measures in order to avoid such situation. Especially, the Specifications must contain wordings about propeller pressure pulses, tip clearances, main engine elastic mounting, continuity of main structure and proper support of the accommodation deckhouse.

The **low-speed diesel main engine** and the **propeller** are the principal vibration exciting sources. The hull structure responds as a both ends free beam when subjected to dynamic loads.

Excitation forces from the propeller are transmitted into the ship via the shaft line and also in the form of pressure pulses acting on the ship hull surface above the propeller. Whereas propeller shaft forces (bearing forces) are the most significant factor for vibrations of shaft lines, the pressure fluctuations on the hull surface (hull surface forces) are the predominant factor for vibrations of ship structures.

Dynamic forces from the shafting system are transmitted to the hull through shaft bearings. The propeller induces fluctuating pressures on the surface of the hull, which induces vibration in the hull structure. The main and auxiliary engines can directly cause vibrations through dynamic forces transmitted through their supports and foundations. The response to this forcing can cause the vibration of the hull girder, deckhouse, deck and other structures, local structures and equipment.

The following measures should be taken in order to avoid excessive vibration of ship structure and equipment:

1. During the initial stern lines fairing and propulsion system arrangement studies, check the maximum angles and minimum propeller clearances.
2. During the initial engine selection, check the 2nd order vertical moment M_{2v} from potential vendor and calculate the Power Related Unbalance.

$$PRU = M_{2v} \text{ (Nm)}/\text{Engine Power (kW)}$$

If the PRU exceeds 220 Nm/kW, consider either change of engine selection or installation of moment compensators. Also, the installation of engine lateral stays on the engine room structure is to be addressed at the early design stage.

3. The ship is to be designed with particular care to continuity and alignment of bulkheads and walls to create stiff foundations for the accommodation deckhouse.
4. Longitudinal deckhouse walls shall be supported on longitudinal bulkheads running from the fore bulkhead of the Engine Room to the transom.
5. Longitudinal shear stiffness of the deckhouse should be maximised by means of continuous longitudinal walls having as few and small cut-outs as possible.

Vibration measurements

The evaluation of vibration on board the ship shall be based on the results of measurements carried out under the following conditions:

- wind force not more than 4,
- sea state not more than 3,
- water depth greater than 5 times the draft of the ship,
- ballast loading condition,
- sailing ahead,
- course straight or slightly turning,
- rudder position up to 2 deg,
- shaft power 90% of MCR,
- rated revolutions,
- two auxiliary engines running.

Full-scale measurements shall be carried out according to Vibration Test Plan prepared by a specialist company which will conduct the tests. A Vibration Tests Report should be prepared. The vibration measurements can be performed according to ISO 4867-1984 "Code for measurement and reporting of shipboard vibration data", and ISO 4868-1984 "Code for measurement and reporting of shipboard local vibration data".

Vibration measurements will be carried for all ships. However, with positive results on the first ship, the Owner may suspend the measurements for the sister ships.

Vibration damper – A device fitted to an engine crankshaft to suppress or reduce the stresses resulting from **torsional vibration**.

Vigilance system – A system provided to verify the officer of the watch alertness.

VIKING EVACUATION MINI CHUTE

The double-ended ferry DOKTOR WAGEMAKER carries 1750 passengers on the 20 minutes crossing. The vessel is provided with four Viking Evacuation Mini Chutes (VEMC) (installation height 12.7m) with incorporated self-righting liferafts and 4x150-man liferafts to safeguard the lives of passengers. Each VEMC system is capable of evacuating 354 people in just 30 minutes and is specially designed to suit smaller vessels operating even in heavy seas. The system has a reinforced Kevlar chute with non-abrasive lining for controlled descent directly into high capacity self-righting liferafts. While the inner lining acts as a gentle brake, the outer lining is specially reinforced to protect evacuees from the environmental hazards, such as severe weather conditions.

The systems are fitted at the saloon deck level and incorporate a chute with a landing platform, housed in the same enclosure.

For more information visit www.VIKING-life.com

VIKING MARINE EVACUATION SYSTEM

In the event of an emergency at sea where there is a need to abandon ship, every second counts and rapid evacuation is a must. The VIKING Evacuation Slide (VES) is the slide-based evacuation system which enables passengers and crew to board liferafts in a quick and safe manner without having direct contact with water. The dual-track slide consists of 12 main longitudinal tubes within 8 separate main compartments, each individually inflated. The slide is connected to a 100 person self-draining boarding platform. This platform can be cut free from the slide and function as a supplementary rescue craft. The 30° angle between the slide and the ship ensures that the system can compensate and absorb extreme ship and sea movements.

The self-contained and very compact stowage box allows installation anywhere on the ship: on open deck, between decks in open recess or can be built into the ship side. The VES itself does not require any external power supply. It is activated by nitrogen pressure, released by one handle. The front door opens and pulls out the slide and platform and immediately starts inflation. A wide range of different liferafts can be used in combination with the slide system ensuring a very high degree of flexibility.

DD-MES Alu System Type 3.3 is designed for built-in installation especially on fast speed crafts or other vessels with high focus on weight. Providing direct access from the accommodation area, it allows for speedy evacuation in case of emergency: 500 people within 30 min. Weight 1950kg for 12m slide version or 2100kg for version with 18m slide.

For more information visit www.VIKING-life.com

Viscosity – A measure of a fuel resistance to flow. The viscosity of a fuel is an indication of the ability to pump, treat, and atomize the fuel. The viscosity value of a fuel must always be associated with the temperature at which the viscosity was determined. The kinematic method of measuring the viscosity of a fuel is used; the kinematic centistoke (cSt = mm²/s) system of viscosity at 50°C.

Vital auxiliary pumps – They are pumps directly related to and necessary for maintaining the operation of the propulsion machinery. For diesel propulsion-engines fuel oil pump, lubricating oil pump, cooling water pumps are examples of vital auxiliary pumps.

V-Max tankers STENA VISION and STENA VICTORY

Delivered by Hyundai, the 314,00dwt vessels STENA VISION and STENA VICTORY have one parameter in common with traditional VLCCs and that is the length, 333m. With a breadth of 70m, the vessels are, however, 10m wider than a conventional tanker designed for the same cargo intake.



Photo courtesy of Stena Bulk



Photo courtesy of Stena Bulk

The aft-end of the vessel is characterised by the large transom stern, twin, widely-spaced funnels and an accommodation deckhouse which houses a complement of 34, plus 6 Suez crew and 4 repair men. Note the huge structure of the bridge wings.

With such a huge beam, it has been possible to select a design draught of 16.76m, allowing navigation on the Delaware River with minimal lightening at the river entrance. This is one of the cornerstones of the Stena Max concept.

Another one is **redundancy**. V-MAX vessel is equipped with double systems for its propulsion featuring two main engines, two **rudders**, two **propeller shafts**. Two separate engine rooms made STENA VISION the first vessel to reach the requirements issued by DNV for its **Redundant Propulsion** and Separate class notation.

The third is speed. The power output is higher compared to conventionally built tankers of the corresponding sizes to secure a high degree of operational reliability also in adverse weather conditions. A fourth is operational life. These vessels are designed with the steel strength that will overcome fatigue stress during an operational life of 40 years. Paintwork is also done to a very high standard.

The double-skin hull is divided by a series of transverse and two longitudinal bulkheads, into 15 cargo and 2 slop tanks. Radar-type tank sounding equipment is fitted, and tank washing is effected using Scanjet machines.

The propelling machinery comprises two low-speed engines, each developing 21,490bhp at 105rev/min. A Vulkan clutch in each propulsion line connects with a Schelde gearbox, reducing revolutions to 66rev/min at the FP propeller for better efficiency.

Electrical requirements are met by four diesel alternators fitted in the third, centre engine room, and steam is produced in a thermal-oil system to drive three 5,500m³/h cargo pumps.

Three cargo grades can be handled simultaneously with a maximum unloading rate of 16,500m³/h.

Length, oa: 333.49m, Length, bp: 320.00m, Breadth, mld: 70m, Depth: 25.60m, Draught design/scantling: 16.76/19.00m, Gross tonnage: 163,761t, Deadweight design/scantling: 266,200/312,600t, Output (MCR); 2 x 21,490bhp x 105rev/min, Service speed (15% sea margin); 16.90 knots, Crew: 34.

Void space – An enclosed space in the **cargo area** external to a **cargo tank**, other than a **hold space**, ballast space, oil fuel tank, **cargo pump-room**, **pump-room**, or any space in normal use by personnel, (IBC Code).

Voith Cycloidal Rudder – The Voith Cycloidal Rudder is based on the **Voith-Schneider Propulsor**. It has a rotor casing that can rotate about a vertical axis, with two axially parallel rudder blades or hydrofoils projecting from it. Fundamentally, there are two different operating modes: passive and active. In the passive mode, the VCR acts as a conventional rudder and is used for this purpose when the ship is cruising. The active mode is used at low speed, e.g. in port. The VCR is then a high-precision source of propulsion when manoeuvring.

Voith-Schneider Propulsor (VSP), also cycloidal propeller –A type of the azimuthing propulsor which generates thrust by means of profiled blades that project from the bottom of the ship. The blades are mounted in a rotor casing that is flush with the bottom of the ship. The energy required to rotate the rotor casing is supplied by an engine via the reduction gear and the bevel gear. The rotor casing is axially supported by the thrust plate and centered radially by the roller bearing.

The blades perform an oscillating motion controlled by the crank-type kinematics system. The amplitude and phase of this motion is determined by the position of the lower end of the pivoting control rod.

The control rod is actuated by two servomotors:

- The propulsion servomotor is used to adjust the pitch for forward and reverse motion of the ship.
- The rudder servomotor is used for transverse thrust (motion to port and starboard).

The amount and direction of the thrust can be determined very quickly. The VPS operates at a comparatively low revolution speed and is characterized by long service life and very low maintenance requirements.

The VPSs are used primarily on Voith Water Tractors, double-ended ferries, mine countermeasure vessels, passenger ships, buoy layers and floating cranes.

Voith Turbo Fin – The Voith Turbo Fin is a rotating cylinder at the end of the skeg. It ensures stable flow and increases lift by means of the larger angle of attack. As a result, significantly higher transverse forces can be achieved - a useful advantage on escort duties in particular. The steering force of a **Voith Water Tractor** with Voith Turbo Fin is 18% greater than that of a conventional tractor. See also **Escort tug VELOX**.

Voith Water Tractor – A tug driven by the Voith-Schneider propellers arranged in the forebody. Underneath the propellers there is a nozzle plate. Its nozzle effect increases the propeller thrust. It also protects the propellers against grounding and supports the vessel in the dock. There is an effective stabilizing fin located underneath the aft body.

This provides adequate course stability and shifts the center of lateral resistance aft, thus increasing the lever arm between the propeller thrust and the pivot point.

One of the major fields of application for the VWT is in escorting large tankers with their hazardous loads safely through narrow, winding channels. Such water tractors are especially suitable for escorting supertankers at high transit speeds.

Volatile Organic Compounds (VOC) Recovery Systems

Volatile Organic Compounds (VOC) are light components of crude oil, which evaporate during loading operations or during the carriage of high-volatility crude oil cargoes. The cargo vapour needs to be vented to the atmosphere to prevent pressures in the tank reaching dangerous levels. Large quantities of VOC are also emitted to the atmosphere during loading of shuttle tankers in oil fields. It is estimated that annual VOC emissions in the Norwegian regime are almost 350,000t, of which around 200,000t are attributed to shuttle tankers and other crude oil carriers.

STATOIL has been investigating VOC emissions since the mid 1980s. A survey on two shuttle tankers in 1987-89 demonstrated that difference between cargo loaded on the field and the amount delivered into the receiving terminal ashore was almost 0.2% by weight. For a 100,000t load, the loss is thereby 200t.

The discharge of VOC creates environmental problem and represents a great loss of energy. Two solutions can be adopted: VOC re-absorption, whereby vapour is returned to the cargo, and VOC reliquefaction.

A pilot plant for VOC collection and re-absorption into the cargo was installed aboard the 113,000dwt shuttle tanker TOVE KNUTSEN in 1994, and achieved a recovery rate of roughly 75%.

On 19th May 1999, the 400m³ VOC fuel tank and the deckhouse with all main equipment for VOC recovery and fuel distribution were placed onboard the NAVION VIKING. It was the first plant engineered with twin objectives of minimising the release of VOC into the atmosphere and using the recovered, condensed vapour to fuel the propulsion machinery.

The plant designed by Wärtsilä Hamworthy comprises VOC compressor, which takes the feed gases from the cargo tanks. The compressed gas is then led into seawater cooler where the first phase of liquefaction and separation takes place. The gases are put through a gas drying process. Gases from the first stage are fed through a duplex molecular sieve dryer which takes the dew point down to around -50°C. One unit dries the gas while another is regenerated with heated surplus gas from the second stage.

In second stage liquefaction the dry gases enters a stack of six plate exchangers. Three exchangers use remaining gas (ethane and all methane), inert gas and cold VOC from the second stage separator as coolant. The other three use cold propylene produced from a separate cooling plant as coolant. The gas/liquid mix is then fed to a separate tank where half of the ethane and all the propane, butane and all higher hydrocarbons fall out as liquid. Surplus gas is used for heating and regeneration of the dryer before it is vented.

VOC is pumped re-warmed in the plate exchangers before it mixes with liquid from the first-stage separation and is led to the VOC storage tank on deck. VOC is used either as fuel for the main engines or is reinjected back into the cargo tanks.

Hitec Marine AS has developed a system for return of VOC emission gases from the shuttle tanker to the FPSO. The VOC recovery process is based on direct absorption of VOC in a side stream of loading oil. The oil containing absorbed VOC is then re-mixed with main oil loading

stream. The equipment is assembled on a standard modular turnkey skid, which is supplied ready for hook-up to the applicable ship's system.

Volatile petroleum – Petroleum, having a flash point below 60°C as determined by the closed cup method of testing.

Volume of displacement – The total volume of water displaced by the ship.

Voyage data recorder (VDR) – A maritime “black box”. VDR is usually two-part system consisting of a data collecting unit, and a protected storage unit that stores the retrieved data. The main component of the system is carried inside the ship and is connected to a deck-mounted protective capsule which houses a fixed high-capacity solid state memory block. The capsule is designed to withstand fire, deepsea pressure, shock and penetration.

The data collecting unit continuously records 12 hours of onboard activity including date and time; ship position; speed; heading; bridge audio; ship VHF communications relating to operations; radar information showing actual radar picture at the time of recording; depth under keel; rudder angle; engine order and response; hull opening status; watertight and fire doors status; hull stress monitoring and wind speed and direction.

For more information visit www.kelvinhughes.com, www.ruttertech.com, www.sam-electronics.de



Photo: J. Babicz



Photo: C. Spigarski

Simplified Voyage Data Recorder (S-VDR) – A system that the **International Maritime Organisation (IMO)** has mandated for carriage on the majority of large sea going vessels. It is a system similar to the aviation “black box” recorder where if a vessel is involved in an accident or sinks, data can be retrieved to reconstruct the last 12 hours of the vessels voyage. This allows the marine community to understand clearly the reason of the accident, however catastrophic and take up preventative measures to increase future marine safety. The International Maritime Organisation finally approved the mandatory requirement for the S-VDR system at MSC 79.

The new rules stipulate that existing cargo ships on international voyages shall be fitted with an S-VDR as follows:

“20,000 gross tonnage and upwards constructed before 1 July 2002, at the first scheduled dry-docking after 1 July 2006 but not later than 1 July 2009”

“3,000 gross tonnage and upwards but less than 20,000 gross tonnage constructed before 1 July 2002, at the first scheduled dry-docking after 1 July 2007 but not later than 1 July 2010”

Useful website: www.s-vdr.com

W

Wake – Moving forward, a ship imparts the forward motion to the water at the stern. It is known as the wake.

Wake equalization duct – The propulsion improving device, especially for full block ships, developed by Professor Schneekluth. It consists of two nozzle-shaped halfring ducts installed on both sides of the stern ahead of the **propeller**. The duct accelerates the flow into the top half of the propeller plane and slow it down slightly in the lower part, thus achieving a more homogenous **wake field**.

LNG gas carrier INIGO TAPIAS is fitted with Schneekluth Hydrodynamic wake ducts to improve aft water flow and enhance the propeller performance.

Wake fraction coefficient – The speed of advance of the propeller " V_A " relative to the water in which it is working is lower than the observed speed of the vessel " V ". This difference in speed, expressed as a percentage of the ship speed, is known as the wake fraction coefficient " w ".

$$w = (V - V_A) / V$$

The value of the wake fraction coefficient depends largely on the shape of the hull, but also on the propeller location and size, and has great influence on its efficiency. For ships with one propeller, the wake fraction coefficient " w " is normally in the range of 0.20 to 0.45. Ships with a large block coefficient have a large wake fraction coefficient and the distribution of the water velocity around the propeller is very inhomogenous under such condition.

Wake-field – When the ship is sailing ahead, the friction of the hull will create a boundary layer of water around the hull. The velocity of the water on the surface of the hull is equal to that of the ship, but is reduced by the distance from the surface of the hull. The thickness

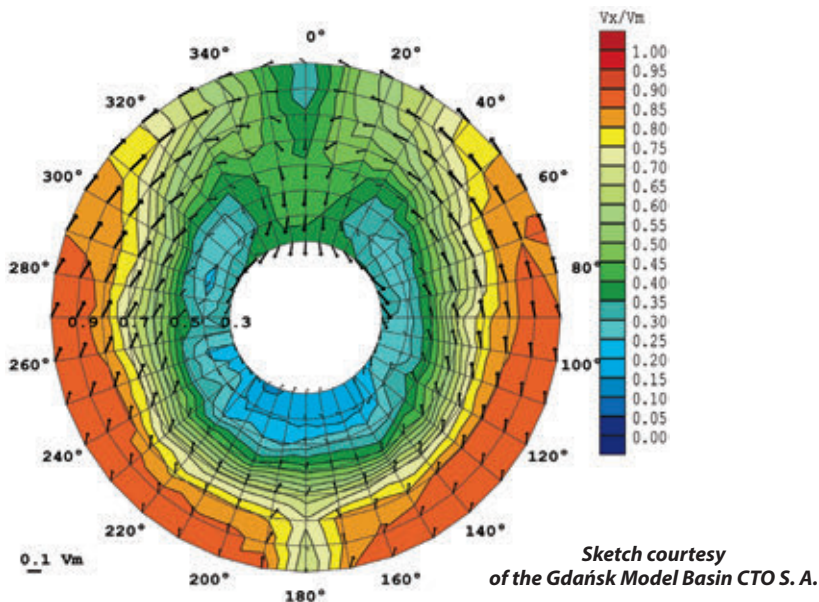

of the boundary layer increases with its distance from the bow. The layer is therefore the thickest at the end of the hull. It means that there will be a certain wake velocity caused by friction along the sides of the hull. Additionally, the displacement of water by the ship will also cause wake waves both fore and aft. All this results in the propeller behind the hull is working in non-uniform water flow called wake-field.

The wake distribution is measured behind the ship model using pitot tubes or laser-Doppler velocimetry. The results are usually displayed as contour lines of the longitudinal component of the velocity. These data plays an important role in the propeller design.

Warping head, warping end, gypsy head – A cylinder-like fitting at the end of winch or windlass shafts. The fiber line or wire rope is hauled or slacked by winding a few turns around it, the free end being held taut manually as it rotates. Warping ends are used mostly for auxiliary purposes such as hauling ropes across a deck or for handling additional mooring lines.

Wash – The waves and ripples spreading out from a vessel when underway.

Wash bulkhead – A perforated bulkhead fitted into a cargo or deep tank to reduce the sloshing or the movement of liquid through the tank.

Washing machines – Tank washing machines either fixed or portable. They consist of revolving nozzles moved by water-driven gearing to create a spherical wash pattern or “cycle”.

There are two types of crude oil washers; single nozzle and twin-nozzle ones. In single nozzle units, it is possible to set the machine to wash the tank in two or three stages. This allows the machines to start washing the upper part of the tanks soon after the discharge begins. As the level is lowered, the second stage is washed and then the third when the tanks are almost empty. A twin-nozzle machine cleans the entire tank in a single programme.

With portable machines, both the machine and its flexible water supply hose are placed into the top of the tank to be cleaned through an opening called the “Butterworth Port”. The machines are progressively lowered down the height of a tank in stages or “drops” each usually of 10-15 feet. The graduation markings every 5 feet on the water supply hose are a useful check of the depth of the machine inside the tank. The lowest “drop” is normally about 5 feet above the “bottom” of the tank where the machine is positioned for a “bottom wash”. The wash duration at each drop is usually for one cycle of the machine, the cycle time varying between 30-60 minutes according to the size of the machine and its pump pressure.

Throughout the washing operation, cargo residues mixed with washing water are continuously stripped from the cargo tanks by the normal cargo pumps. These washings are directed through the cargo line system into the reception tanks, a slop tank or in some instances to shore facilities.

Waste – Useless or superfluous matter which is to be discarded. Incineration of burnable waste is the most efficient means of disposal.

Cargo-associated waste – All materials which have become waste as a result of use on board a ship for cargo stowage and handling: dunnage, shoring plates, lining and packing materials, plywood, paper, cardboard, wire and steel strapping.

Domestic waste – All types of food wastes, sewage and wastes generated in the living spaces on board the ship.

Food wastes – Spoiled or unspoiled victual substances, such as fruits, vegetables, dairy products, poultry, meat products, food scraps, food particles, and all other materials contaminated by such wastes, generated aboard ship, principally in the galley and dining areas.

The amount of food waste on board a cruise ship makes the proper treatment a necessity. The equipment includes pulpers, disposers (for bones) and water extractors.

Hazardous waste – Anything that is flammable, corrosive or toxic but also including solvents, oils and other substances.

Maintenance waste – Materials collected in the engine and deck departments while maintaining and operating the vessel, such as soot, machinery deposits, scraped paints, deck sweeping, wiping wastes, rags, etc.

Medical waste – Infectious agents, human blood and blood products, body parts, contaminated bedding, surgical waste and additional medical items.

Operational wastes – All cargo-associated waste and maintenance waste, and cargo residues defined as garbage under cargo residues.

Waste heat recovery (WHR) – The energy from the combustion process in an internal combustion engine not converted into useful work, e.g. energy in the exhaust gas or cooling water.

Waste heat boiler – A boiler which uses the exhaust gas from an engine to produce low pressure saturated steam.

Waste management plan – Collection, treatment and disposal of waste.

Waste water –

Black water – Drainage from toilets.

Black water has a high biological oxygen demand and can increase other nutrients in the water, and also can have the potential to introduce disease.

Galley water – Galley water can contain oil, fats and detergents – all of which have a detrimental effect on marine life.

Grey water – Drainage from dishwasher, showers, laundry, bath and washbasin drains and does not include drainage from toilets, urinals, hospitals and cargo spaces. Each person can produce between 170 and 350 litres of grey water a day. Grey water contains soap, dental waste, antiseptics, disinfectants, deodorants and other substances.

Waste water treatment systems – Plants installed to treat any intended discharges overboard. The central elements of these plants – the one which removes suspended solids and bacteria – uses either a biological or non- biological process. Biological processes rely on natural bugs to treat the waste. Non-biological process utilizes an electro-mechanical oxidation procedure to treat wastewater streams. All the systems, biological and non-biological, claim to be capable of dealing with grey water, black water or mixed streams and of producing effluent for discharge that meets IMO Marpol 73/78 requirements. See also **Sewage treatment**.

Watch – A time period, usually of four hours, e.g. 12-4, 4-8, 8-12, which operates round the clock. It is the working period for one or more officers and crew in the navigation and engineering departments.

Continuous watch – Continuous watch means that the radio watch concerned shall not be interrupted other than for brief intervals when the ship's receiving capability is impaired or blocked by its own communications or when the facilities are under periodical maintenance or checks (**SOLAS**).

Watch alarm – An alarm that is transferred from the bridge to the master and the backup navigator in the event deficiency (absence, lack of alertness, no response to another alarm/warning, etc.), of any officer on watch. See also **Vigilance system**.

Watch alarm system – The watch alarm system urges the officer on watch at a predetermined time to acknowledge his watch-keeping awareness.

Water-based local fire fighting system – According to **SOLAS 2000-Amendments** and **IMO MSC/Cir. 913** vessels constructed on and after 1st July 2002 have to be provided with type approved fixed water-based local fire-fighting systems in addition to the main system. Such systems can be activated without the necessity of engine shutdown, personnel evacuation or sealing of the spaces. Fixed local systems are to protect areas such as the fire hazard portions of engines used for propulsion and power generation, boiler fronts, the fire hazard portions of incinerators, and purifiers of heated fuel oil.

Water curtain – Some tankers have a fixed system to give a protective water curtain between the cargo deck and the superstructure.

Water fog – A suspension in the atmosphere of water divided into coarse drops by delivery through a special nozzle for use in fire fighting. When water fog hits the fire and hot surfaces, it vaporises and expands 17,000 times. Once expanded the water vapour gives off the oxygen to quell the fire in addition to the cooling effect of the mist. See also **Hi-Fog system**.

Water fog is supplied through a system of high pressure water lines and fog nozzles. A ring of nozzles around the inside of the tank opening effectively suppresses a cargo tank hatch fire.

Water level gauge – A device to provide a visible indication of water level in the boiler. Due to the motion of the ship it is necessary to have a water level gauge at each end of the boiler to observe the level correctly. For boiler pressure above 17 bar, a plate glass-type water level gauge is used.

Water seal – Water, added to the **separator bowl** to prevent the oil from leaving the bowl through the water outlet, in the **purifier** mode.

Water spray – A suspension in the atmosphere of water divided into coarse droplets delivered through a special nozzle for use in fire fighting.

Waterjet – A propulsor that consists of a water inlet channel with inlet located in the bottom of the ship, a pump that accelerates the water and a nozzle. In concept, it is a ducted propeller where the duct has been prolonged and integrated into the vessel structure. The water is accelerated by an axial or mixed flow pump and thrust out of the stern through a nozzle. Behind the nozzle, a steering and reversing bucket is mounted. It is controlled by hydraulic rams. Water jet units with main steering function are also regarded as steering gear for the vessel.

The reversal of the thrust is achieved by a reversing bucket. Moving the bucket into the jet stream and thereby deflecting it forward, reverses the thrust. The bucket can be gradually inserted into the jet stream, so that only a part of the jet is deflected. This way, the thrust can be controlled continuously from full ahead to full stern just by adjusting the position of the bucket.

Waterjet propulsion – Waterjet propulsion is often chosen instead of conventional propellers for vessels requiring high speeds, shallow draught, protected propulsion, high manoeuvrability at all speeds, low noise emissions for military applications and low vibration.

A typical waterjet system includes a flush-mounted inlet channel guiding the water to the rotating pump impeller, a stationary guide vane package, an outlet nozzle and a steering/reversing mechanism. The basic operating principle of waterjet propulsion is similar to that of a screw propeller system. Namely the propelling force is generated by adding momentum to the water by accelerating a certain flow of water in an astern direction.

The water from under the vessel is fed through an inlet duct to a precision inboard pump, usually mounted at the transom, adding head to the water. This head is then applied to increase the velocity when the water passes through an outlet nozzle into the ambient atmospheric pressure.

The steering and reversing forces are generated by deflecting the jet by a flat-bucket gear which is normally hydraulically operated. For speeds above 30 knots waterjets are more efficient than conventional propellers, they also include benefits like improved manoeuvrability and radical reduction in the ship draught.

An extensive reference list in the ropax fast ferry sector can be claimed by Wärtsilä for its wide range of Lips waterjets. Capabilities in the high power arena are demonstrated by four MEKO A-200 SAN corvettes handed over to the South African Navy by the German yards Blohm+Voss and HDV. A CODAG WARP (combined diesel and gas turbine waterjet and refined propellers) propulsion system embraces two diesel-driven trains with CP propellers and a centreline gas turbine with an output of 20MW driving a Lips 210E waterjet.

With a 2.8m-diameter six-bladed impeller and an intake duct of 2.1m, the waterjets for these projects were at the time the largest ever built and the first applied to naval vessels of this size (121m long/3500 tons displacement).

Further reading: **Waterjets Product Guide**, can be downloaded from www.wartsila.com

Waterline – An imaginary line on a ship side parallel to the base at a particular draft.

Waterplane area – The area of a hull at a particular horizontal plane, i.e. within the waterline.

Watertight – Capable of preventing the passage of water through the structure in either direction with a proper margin of resistance under the pressure due to the maximum head of water which it might have to sustain, (ICLL).

Watertight door – A door which is fitted in a watertight bulkhead and able to open vertically or horizontally. It is operated by a hydraulic mechanism either locally or remotely. It must be substantially constructed and able to withstand the total hydraulic pressure of the adjoining compartment if it floods.

Watertight Integrity Plan – A drawing showing the main and local watertight subdivision as well as internal openings and closing devices thereof. The drawing is essential for the local class surveyor to ensure that proper watertight integrity measures are taken during the building period.

Wave – The travelling undulation of the surface of a liquid. The wave crest moves as the individual surface particles rise and fall but there is no forward motion of the liquid. Waves arise on the surface of the sea due to the action of the wind and their size is related to wind speed.

Waveslope capacity of the fin stabiliser – The maximum static angle of the heel produced by the fin, expressed in degrees. It is commonly referred to as the waveslope capacity of

WÄRTSILÄ WATERJET

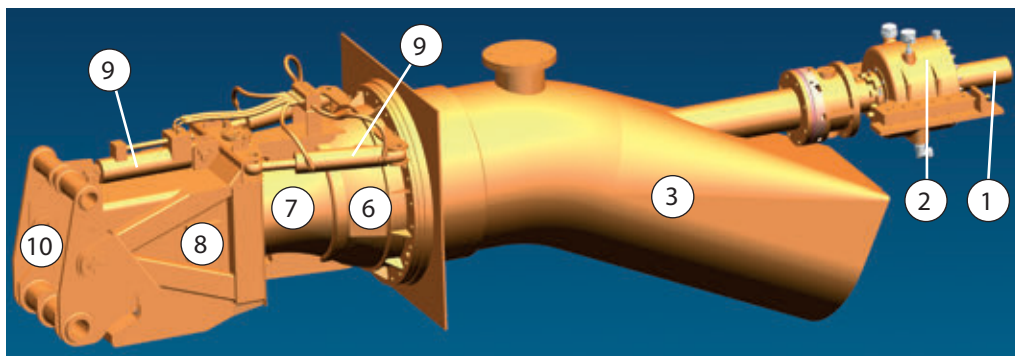

Waterjet with steering and reversing capability

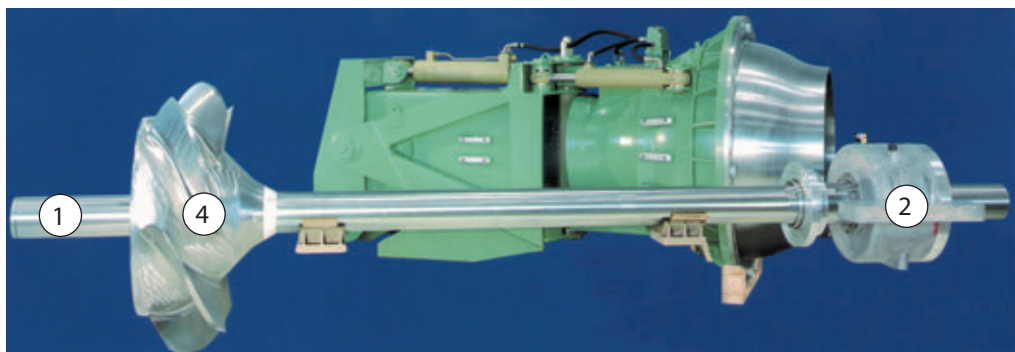
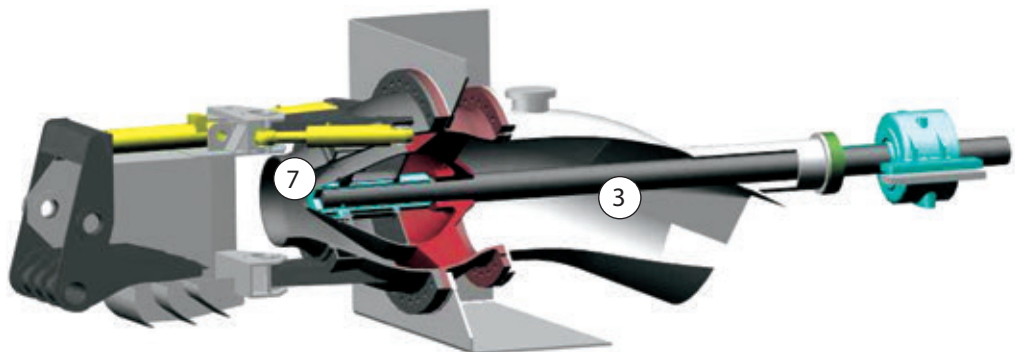

1. Shaft
2. Thrust bearing block
3. Duct
4. Impeller
5. Impeller housing
6. Stator housing
7. Discharge nozzle
8. Steering nozzle
9. Hydraulic actuators
10. Reversing bucket

Illustrations courtesy of Wärtsilä Corporation

the stabilizer as it represents the maximum sea conditions in which full stabilisation can be achieved.

Wear – The deterioration of a surface due to relative motion between it and another.

Weardown gauge – A depth gauge which is inserted into the stern frame boss and through the sterntube bearing to measure the wear that has occurred in the bearing.

Weather chart facsimile, weatherfax – A device used to receive weather reports.

Each ship is provided with a weatherfax receiver with a printing facility which enables weather patterns showing isobars and barometric pressures to be printed at regular intervals.

Weather deck – A deck which is completely exposed to the weather from above and from at least two sides, (SOLAS).

Weathertight – Weathertight means that in any sea conditions water will not penetrate into the ship, (ICLL).

A weathertight fitting shall have a strength at least equal to the bulkhead or deck in which it is fitted. In practical terms, the difference between weathertight and watertight is that a watertight fitting shall withstand water pressure from the outside (be watertight from outside), whilst a watertight fitting shall withstand water pressure from both sides.

Weathertight door – A door fitted in a structure above the freeboard deck. It must be of adequate strength and able to maintain the watertight integrity of the structure.

Web – A flat plate with a flanged or stiffened edge.

Web frame – A deep-section built-up frame which provides additional strength to the structure.

Weld defects – The most common type of discontinuities are: cracks, incomplete fusion, slag inclusions, porosity, undercut. Imperfections of welding connections can be isolated or clustered.

*Further reading: ABS Guide for “**Nondestructive Inspection of Hull Welds**” (2002), can be downloaded from www.eagle.org*

Cracks – Cracking in welded joints can be classified as either hot or cold cracking. Hot cracking is a function of chemical composition. Cold cracking is the result of inadequate ductility or the presence of hydrogen in hardenable steels. Welds in which radiographs exhibit any type of cracks are to be considered unacceptable.

Incomplete fusion – The failure to fuse adjacent beads of the weld metal and the base metal. This condition can be localised or it may be extensive, and it can occur at any point in the welding groove.

Porosity – Gas pockets or voids in the weld metal. The voids come from gas that is formed due to certain chemical reactions that take place during welding.

Slag inclusions – The oxides and nonmetallic solids that sometimes are entrapped in weld metal, between the adjacent beads, or between the weld metal and the base metal.

Undercut – This term is used to describe two situations. One is the melting away of the sidewall of a welding groove at the edge of the bead, thus forming a sharp recess in the sidewall in the area in which the next bead is to be deposited. The other one is the reduction in thickness of the base metal at the line where the beads in the final layer of weld metal tie into the surface of the base metal (e.g., at the toe of the weld).

Weld metal corrosion – A preferential corrosion of the weld deposit due to an electrolytic action between the weld metal and base metal.

Weldability – The capacity of a material to be welded under the imposed fabrication conditions into a specific, suitably designed structure and to perform satisfactorily in the intended service.

Welder – One who performs a manual or semiautomatic welding operation.

Welder certification – A written certification that a welder has produced welds meeting a prescribed standard of the performance.

Welder qualification test – To ensure that a welder possesses the necessary skills to produce a sound weld he must complete a test piece which is representative of conditions that will be encountered during production welding.

Welding – A joining process that produces coalescence of materials by heating them to the welding temperature, with or without application of pressure or by the application of pressure alone, and with or without the use of filler metal.

Welding of hull structures is to be carried out by qualified welders, according to approved and qualified welding procedures and with welding consumables approved by the Classification Society.

Automatic welding – Welding with equipment that requires only occasional or no observation of the welding, and no manual adjustment of the equipment control.

Machine welding – Welding with equipment, which performs the welding operation under constant observation and control of a welding operator.

Manual welding – Welding with the torch, gun or electrode holder and manipulated by hand.

Welding machine – The equipment used to perform the welding operation. For example: spot welding machine, arc welding machine, and seam welding machine.

Welding operator – One who operates adaptive control, automatic, mechanized, or robotic welding equipment.

Welding procedure – The detailed method and practice involved in producing a specific weld.

Welding sequence – The order of making the welds in a weldment.

Welding shrinkage – Distortion of weldments created by localized heating of the metal being joined together.

Well -

1. Space in the bottom of a ship to which bilge water drains so it may be pumped overboard.
2. Any area on the deck exposed to the weather, where water may be entrapped. Wells are considered to be deck areas bounded on two or more sides by deck structures, (ICLL).

Well –

Appraisal well – A hole drilled near to a discovery well in order to determine more information or the extent of the reservoir.

Completed wells – Wells fitted with **Christmas trees** attached to the wellhead, so the flow of fluids in and out of the reservoir may be controlled for production purposes, (ABS).

Well fluid properties

Discovery well – An exploration well which has been successful in finding hydrocarbon deposits.

Well fluid properties – The condition of a well or reservoir defined by depth, temperature, shut-in pressure, flow rate, well fluid composition, etc (ABS).

Well intervention vessel – A dynamically positioned (DP) ship-shaped offshore unit provided with equipment for well stimulation or maintenance (e.g. coil tubing). Such vessels are often able to carry out other tasks as **ROV** operations and general supply duties.



Light well intervention vessel WELL ENHANCER

LOA = 131.70m, Bmld = 22.00m, D = 9.50m, Draught = 6.25/6.75m, Deadweight = 6750/7950 dwt

1. Gas-tight accommodation,
2. Diving equipment section,
3. Deepwater deployment tower,
4. 100t crane

Well maintenance - Worldwide there are more than 3000 subsea wells and, to increase the oil recovery from these wells, there is a demand for an efficient live well intervention service. This includes repair, scale removal, installation and manipulation of valves, plugs, screens, etc., perforations and re-perforations, zone isolation, fluid sampling, chemical treatment, well abandonment etc. Traditionally, this type of work has been done by drilling rigs since these were fitted with the necessary equipment for carrying out the position operation, the entering of the well and lowering of the tools into the well. However, with this approach several days of operation is required before any productive work in the well can commence due to the time required for positioning and anchoring of the rig and installing the workover riser system.

In recent years there is a trend to use light well intervention technology which makes this type of service possible from a ship-shaped **well intervention vessel**. The technology reduces the intervention cost to 1/3, enabling more intervention work and resulting in better exploitation of subsea wells.

Well Test Systems – Facilities installed on vessels or mobile offshore drilling units (MODUs) for the purpose of evaluating the quality and/or quantity of well fluid to determine whether the well should be completed for production or plugged and abandoned. Well test systems may include well control equipment, process pressure vessels, piping and electrical components, control systems, burners and gas flares and burner/flare booms.

Further reading: ABS Guide for Well Test Systems, 2010.

Wellhead – Equipment used to secure and seal the casings and production tubing and to provide a mounting place for the Christmas trees.

WETPAC humidification – The NOx reduction technology developed by Wärtsilä. Pressurized water is added to the intake air after the turbocharger to reduce the combustion temperature and thereby the formation of NOx. The water evaporates immediately and enters the cylinders as steam, lowering the combustion temperature. A water mist catcher prevents water in liquid state from entering the cylinders. The NOx reduction is up to 40%, and the water consumption is about two times the fuel oil consumption.

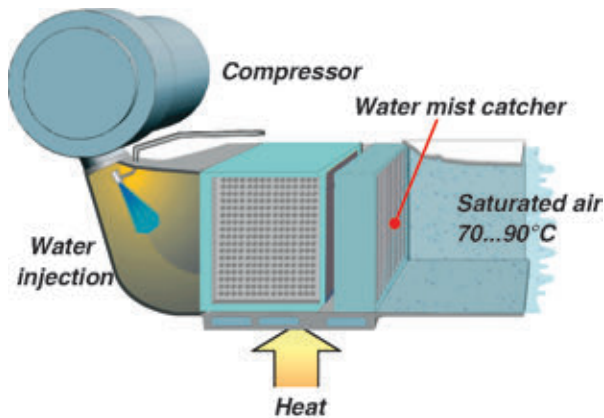

Working principle of Wärtsilä WETPAC humidification

Wet surface hull scanner (WSHS) – A new technology using **remotely-operated vehicle (ROV)** for hull survey developed by **Det Norske Veritas**. Resonance thickness measurement sensors are mounted in an array ten wide across the full width (1m) of ROV. This crawls over the hull surface taking mean thickness measurements at the speed of up to 1 m²/sec. The ROV's movements are controlled by special positioning and navigation systems. The scanner can also be used internally for scanning tanks in ballasted condition.

Wetted surface – For a ship floating at a given waterline, the wetted surface is the total area of her outer surface in contact with the surrounding water. It is one of the factors which resists the movement of the ship in water.

Wide Tow – Towed seismic spread with significant lateral separation. Normally, it requires the use of paravanes.

Wind Turbine Installation Vessel INNOVATION

Delivered in August 2012, the INNOVATION is a self-propelled powerful jack-up built by CRIST S.A. shipyard in Gdynia (Poland). The vessel had been designed and constructed according to the requirements and under the survey of the Germanischer Lloyd for the following class:

Wind Turbine Installation Vessel INNOVATION

+ 100 A5 SPS (except SRtP), Vessel Self-Elevating Unit, Operation acc. to Operation Manual, S9P65, DP2, OSV, WTIS, EP, NAV-OC, Strengthened for heavy cargo, +MC AUT.



The vessel is equipped with 4 independent legs of 3-Chord truss type with spud cans and high speed Rack and Pinion Jacking System. The system consists of 96 elevating units, divided into 4 layers and is able to operate even if one layer is lost.

Key features on the vessel include a 1500t SWL @31,5m main crane, plus a 40-tonne-capacity auxiliary crane, accommodation capacity for 150 persons, a maximum operating depth of 50m and an ability to jack with 8000t of cargo on board.

The Liebherr heavy lift offshore crane is designed as “Crane Around the Leg”, which means that it is able to rotate 360° around the leg. The main advantage of this design is that despite the enormous size of the crane it can be positioned in a space-saving way and requires a relatively small obstruction area of 12m.

The unit is equipped with a diesel-electric power plant: electric power for propulsion and other services is derived from six generator sets located in three separated compartments. They provide total onboard electrical power of 34.4MW and feed two 6600V high-voltage propulsion switchboards equipped with vacuum circuit breakers.

The DP2 dynamic positioning system is based on four 3500kW aft azimuthing thrusters and three 2800kW forward tunnel thrusters. A transit speed of 10 knots can be achieved. All drives are speed-controlled by low-voltage PWM-converters.

A NACOS platinum bridge-based automation, control and monitoring system has been installed. The automation sector can process approximately 4500 input and output signals controlled by 10 process stations, with operator control possible in differing locations such as the Engine Control Room and officer cabins in addition to the bridge.

WIND TURBINE INSTALLATION VESSEL INNOVATION

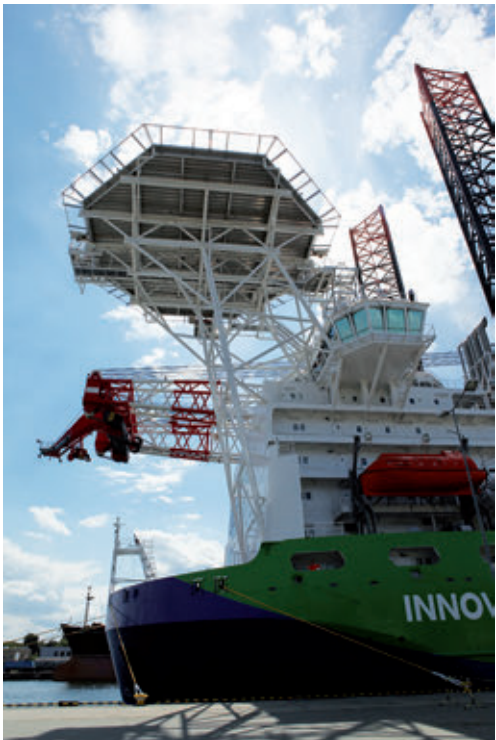

Photos: C. Spigarski

Wheelhouse

Length, oa: 188.70m, Hull length: 147.50m, Breadth, mld: 42.00m, Depth to main deck: 11.00m, Draught design/scantling: 7.00/7.348m, Deadweight design/scantling: 9323/11,166dwt, Open deck area: 3600m², Light ship mass including legs: 24,371t, Service speed at 90% MCR: 10 knots, Main engines: 6x4500kW diesel-generator sets, Propulsion azimuthing thrusters: 4x3500kW, Bow tunnel thrusters: 3x2500kW.

Wheelhouse – An enclosed space in which the main steering wheel, controls, engine room telegraph, etc., are located.



Adjustable wheelhouse

Adjustable wheelhouse, retracting wheelhouse – A wheelhouse which can be lowered in order to reduce the **air draught**. The hydraulically operated, retractable wheelhouse can be entered from the **accommodation** area when lowered, and by means of outside ladders when raised to its full height.

Whistle – Any sound signalling appliance capable of producing the prescribed blasts.

White metal – A tin-based alloy with amounts of lead, copper and antimony. It may also be a lead-based alloy with antimony. It has a low coefficient of friction and is used as a lining material for bearings.

White petroleum oils – Clean products such as benzene, kerosene and gasoline.

Winch – A machine with a drum on which a rope, cable, or chain for hauling, pulling, or hoisting can be wound.

Wind and water strakes – The strakes of side shell plating between the ballast and the deepest load waterline.

Wind Turbine Installation, Maintenance, and Repair Unit – A mobile offshore unit primarily intended for the installation, maintenance and repair of wind turbines in offshore and coastal waters, including pile driving, tower installation, and nacelle and blade installation.

Usually a self-elevating unit with movable legs capable of raising its hull above the surface of the sea. Once on location, the hull is raised to a predetermined elevation above the surface on its legs, which are supported by the sea bed. The legs may be designed to penetrate the sea bed, may be fitted with enlarged sections or footings, or may be attached to a bottom mat.

Jacking systems are used to elevate and lower the hull and to raise and lower the legs in the afloat condition. The hull of the unit is maintained stationary in the elevated condition by means of a holding mechanism. The same mechanism is used to maintain the legs stationary in the afloat condition.

Deck cargo includes wind turbine nacelles, towers, blades and any other items which are installed in association with a wind power generation structure. It also includes any temporary structures such as racks, stands, or cradles which are not permanently attached to the unit.

See also **Wind Turbine Installation Vessel INNOVATION**.

Further reading: ABS *“Guide for Building and Classing Mobile Offshore Units”*

Windlass – A machine designed to hoist or lower an anchor. It consist of a horizontal barrel that is fitted with gear-like projections (**cable lifter**) that engage the links of the anchor chain.

Windlass trials – Each windlass is to be tested under working conditions after installation onboard. Each unit is to be independently tested for braking, clutch functioning, lowering and hoisting of the chain cable and anchor, proper riding of the chain over the chain lifter, proper transit of the chain through the hawse pipe and the chain pipe, and effecting the proper stowage of the chain and the anchor. The mean hoisting speed is to be measured, with each anchor and at least 82.5m of length of the chain submerged and hanging free. The braking capacity is to be tested by intermittently paying out and holding the chain cable by means of the application of the brake.

Windows – Windows are not allowed to be used in superstructures or in the ship shell, but only in deckhouses. However, if the deckhouse protects an opening in the deck, deadlights are required.

Windward – The direction from which the wind is blowing.

Wing in ground-effect craft (WIG) – see **Ekranoplans**.

Wire winder – A ring mounted on the propeller hub in order to protect the sterntube aft seal. See also **Net cutter**.

Wire-winder prevents fishing lines and other thin filaments entering into the stertube aft seal and damaging the lip seals.

Wiring diagram – A drawing which shows the detailed wiring and connections between items of electrical equipment and may also show the routing of connections.

Workboat – Usually, a small pontoon type, flush deck craft designed to carry out a wide range of work.

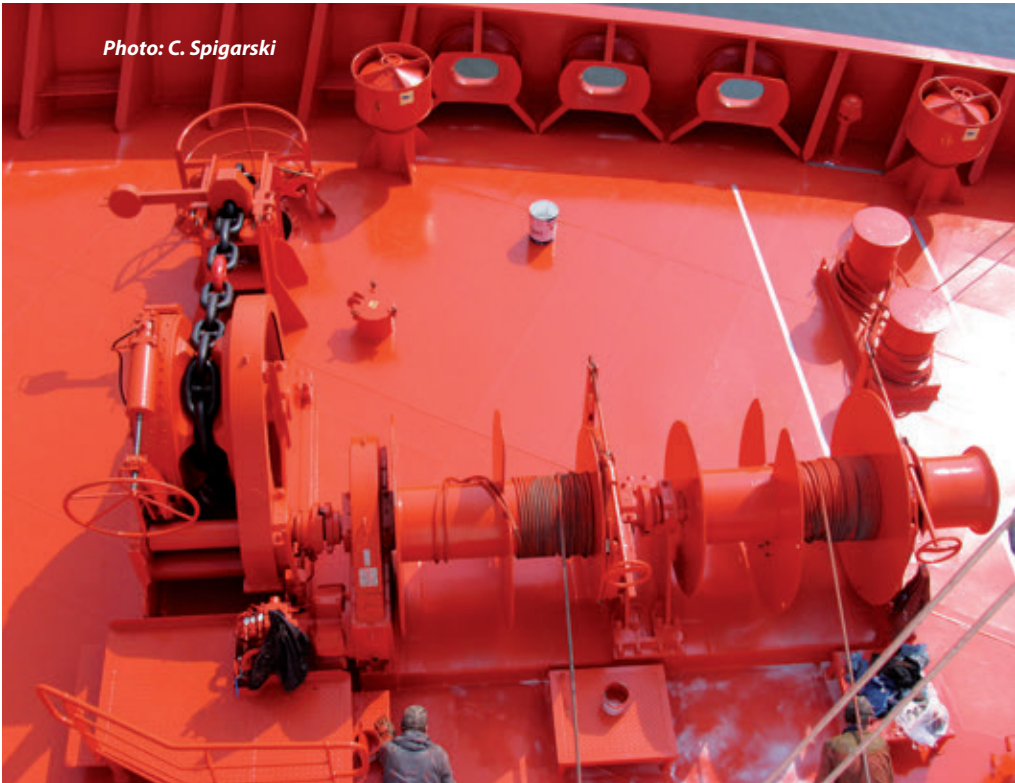

Combined windlass/mooring winch from TOWIMOR S.A. onboard product carrier BOW SKY built in Szczecin New Shipyard.

Workboat BELRYAR

The multipurpose workboat BELRYAR features a pontoonshape and a double chine bow. **Amidships** aft, the hull is fitted with a double plate **skeg** to improve directional stability. It is propelled by two fixed-pitch propellers running in propeller nozzles. A ro-ro loading ramp has been arranged in the front and is suitable for transfer of a bulldozer. A hydraulic deck crane is fitted forward on the working deck in port side. The deck crane, featuring a slewing drive fitted with dowel pins, has the maximum capacity of 16t at an outreach of 11.80m. The hydraulic towing winch fitted amidships in front of the superstructure features a brake holding power of 80t and a drum capacity of 300m 44mm diameter steel wire.

Length on waterline: 30.00m, Breadth, mld: 11.00m, Depth: 2.60m, Propulsion: 2x537kW, Speed: 9 knots, Bollard pull: 15 knots.

Working raft – A small platform used for works on the ship when afloat.

Workmanship – The skill with which something was made.

From BNC Technical Specification:

1. *Workmanship is to be first class throughout and to be to the satisfaction of Owners, Class Society and Authorities.*
2. *All steel works will be carried out according to the IACS Shipbuilding and Repair Quality Standard. Especially:*
 - a) *Welding of hull structures is to be carried out by qualified welders.*

- b) *Records of welders and their certificates are to be kept and made available to Owners for inspection.*
 - c) *Welding operations are to be carried out under shelter from rain, snow and wind, provisions to be made for proper accessibility, staging, lighting and ventilation.*
3. *All other works will be carried performed to high international shipbuilding standards and to be to the satisfaction of Owners, Class Society and Authorities.*

Workover – Re-entry into a completed **well** for modification or repair work.

Workshop – A room where things are made or repaired using machines and/or tools.

Workstation – A position at which one or several tasks constituting a particular activity are carried out.

Manual steering workstation – Workstation from which the ship can be steered by a **helmsman**.

Monitoring workstation – Workstation from where equipment and environment can be checked constantly. When several persons are working on the **bridge** it serves for relieving the **navigator** at the **navigation and manoeuvring workstation** and/or for carrying out advisory functions by the master or a pilot.

Navigation and manoeuvring workstation – Main workstation at which the course, speed and position in relation to the waters and traffic can be controlled and monitored, and where communication relevant to navigation can be performed.

Radiocommunication workstation – Workstation for operating and control of equipment for GMDSS distress and safety communications and general communication.

Route planning workstation – Workstation at which voyages are planned. In case of lack or failure of the automatic visual position indicator, it serves for fixing and documenting the ship position.

Wreck – A ship that has been destroyed or badly damaged.

Y

Yaw, yawing – see **Ship motions**.

Yoke arm – A structure at the end of the vessel that allows only angular relative movement between the vessel and the mooring attachment to the seabed.

Z

Zinc – A hard, white metal with a good resistance to atmospheric corrosion. It is used as a coating for steel in a process called galvanizing and also as an alloying element.

Zinc silicate paints – Zinc-filled paints based on an inorganic binder. Zinc silicates give very hard films, and are resistant to solvents.